

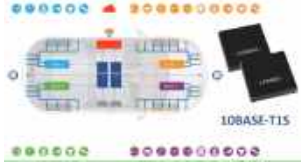



## Advanced View Pic Microcontroller Projects List

### List of Projects using Pic Microcontroller with advance view:

- 

[10BASE-T1S Ethernet: Simplified OEM Design for Auto Devices](#) Introduction Cars these days are surrounded by technology. They come loaded with all sorts of electronic gadgets and sensors. This project wants to help the big car companies, called original equipment manufacturers (OEMs), build cars that can easily share information between all of these onboard..... Listed under: [Blog](#), [Other Projects](#)
- 

[Microchip Introduces Low Pin Count MCU Family with I3C Support](#) Microchip Introduces Low Pin Count MCU Family with I3C Support Microchip has recently unveiled the PIC18-Q20 microcontroller family and the floating the world's first low pin count MCU line for supporting the I3C standard. As for the new product line, it reveals Microchip's efforts to..... Listed under: [Blog](#), [Other Projects](#)
- 

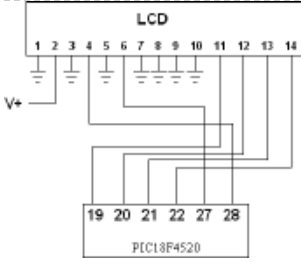
[Microcontrollers: Fundamentals and Applications](#) Overview Various types of computers are tailored to specific functions. The computer inside your laptop, for instance, serves different purposes compared to the ones found in your phone or mouse. At the most basic level, there are computers designed to manage input from the physical..... Listed under: [Microcontroller Programmer Projects](#)
- 

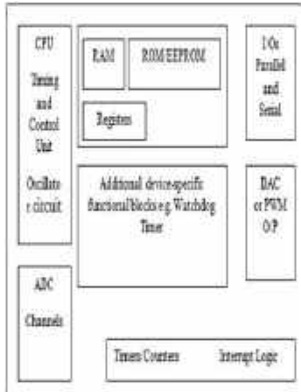
[Interfacing PIC18F4520 microcontroller with an HD44780 LCD](#) Introduction Being able to display data from a microcontroller visually has many advantages. It allows for menus, status indicators, and instructions to be intuitively shown to users. When paired with an LCD, a microcontroller becomes a powerful tool for building interactive electronic devices and systems..... Listed under: [LCD Projects](#)
- 

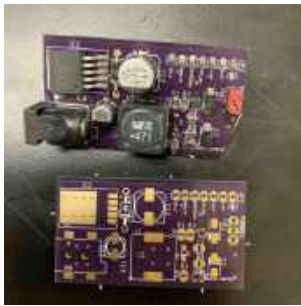
[Advanced Voltage Monitoring and Protection via Microcontrollers and Proteus VSM](#) ABSTRACT This project designed an embedded system using a microcontroller to monitor the amplitude of the main voltage supply and disconnect it if it increases or decreases outside of a predefined required voltage range (RVR). The system also aims to automatically reconnect the supply once..... Listed under: [Other Projects](#)
- 

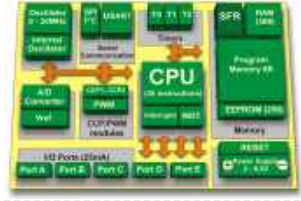
[Ultra-Low Power: Microcontroller Standby Current to 130uA with OPEnS Power Control Board](#) At the OPEnS Lab, a key focus for our projects is achieving exceptionally long battery life. This was particularly true for the OPEnSampler, a device that presented a unique challenge due to its need for simultaneous operation at three different voltage levels (3.3V, 5V, and..... Listed under: [Development Board - Kits Projects](#)
- 

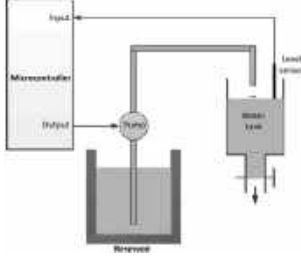
[Navigating the Components of PIC Microcontroller Architecture](#) The Peripheral Interface Controller (PIC), developed by Microchip, stands out among microcontrollers for its speed and ease of implementation compared to alternatives like the 8051. Its programming simplicity and seamless interfacing with other peripherals have contributed to its success. A microcontroller, an integrated chip comprising..... Listed under: [Microcontroller Programmer Projects](#)
- 

[PIC Microcontroller Projects in C: Basic to Advanced – A Project Deep Dive](#) Building Skills Through Projects This project's strength lies in its project-based approach. Learning by doing is a powerful technique, especially in the realm of embedded systems. By working on progressively complex projects, learners can solidify their theoretical understanding of PIC microcontrollers and C programming. [caption]..... Listed under: [Microcontroller Programmer Projects](#)
- [An Application-Driven Microcontroller Curriculum](#) Understanding how to apply microcontrollers lies at the core of modern embedded systems education. This student project takes an experiential approach to introducing microcontrollers through hands-on projects exemplifying their diverse real-world applications. Such practical, solutions-focused learning helps cement fundamental concepts while imbuing students with skills..... Listed under: [LED Projects](#)

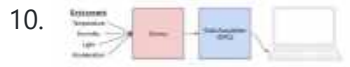

10. [Exploring Various Applications of Microcontrollers: A World of Tiny Brains](#) Exploring Various Applications of Micro Controller Microcontrollers have become ubiquitous in the modern world with applications in nearly every industry. This student project aims to demonstrate various real-world applications of microcontrollers to showcase their versatility and importance across different domains. Exploring the functionality of microcontrollers..... Listed under: [Wifi - WLAN Projects](#)

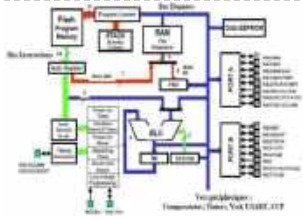

11. [Easy Way to Learn Robotics Using Microcontrollers: A Beginner's Guide](#) The title, "Easy Way to Learn Robotics Using Microcontrollers," promises an accessible entry point for those curious about the exciting world of robotics. This commentary delves into the potential of this project, exploring its strengths, considerations for improvement, and resources to enhance the learning experience..... Listed under: [Robotics - Automation Projects](#)



12. [Mastering Microcontroller Programming: From Basics to Advanced Techniques](#) ABSTRACT A microcontroller, comprising a CPU, RAM, ROM, and I/O ports, is a compact computer integrated into a single circuit board. Its significance in various aspects of daily life cannot be overstated. Unlike general-purpose computers, microcontrollers are specifically designed to carry out predefined tasks or..... Listed under: [Microcontroller Programmer Projects](#)

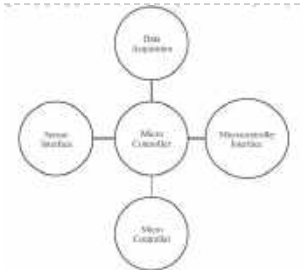

13. [Unveiling the Many Faces of Microcontroller Applications](#) Abstract. A microcontroller, also referred to as an MCU or microcontroller unit, represents an integrated circuit (IC) crafted for specific applications, tailored to execute designated tasks. While commonly employed in products requiring automated control, such as devices, power tools, automobile engine control systems, and computers,..... Listed under: [Other Projects](#)

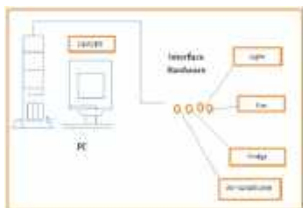

14. [Designing a Microcontroller Framework for PC-Based Control of Electrical Appliances](#) ABSTRACT The preference for personal computers as a platform for designing and implementing control algorithms is growing due to the ease of writing, modifying, and updating software programs for these purposes. In this study, we utilize a personal computer to manage electrical appliances, enabling the..... Listed under: [Other Projects](#)

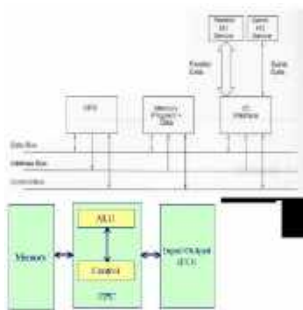

15. [Understanding the Fundamentals: Exploring Microprocessor, Microcontroller, and Programming Basics](#) Common computer organization The Arithmetic Logic Unit (ALU) is a component designed to perform a range of operations, such as addition, shifting, AND, OR, and others, on specific on-chip registers. The Central Processing Unit (CPU) encompasses the control logic, relevant registers, and the arithmetic logic..... Listed under: [Microcontroller Programmer Projects](#)

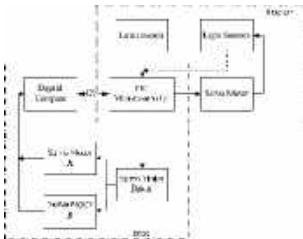

16. [Efficient Sun-Following Robot: A Solar Tracker with Microcontroller Control](#) Abstract The impending global challenge of dwindling non-renewable fuel resources underscores the urgency of transitioning towards renewable energy alternatives like solar power. However, the efficacy of solar energy generation hinges on the intensity of solar irradiation. This project aims to address this by designing and..... Listed under: [Other Projects](#)



17. [Crafting a Microcontroller-Based Temperature Monitoring System](#) Abstract As technological advancements progress, processes become increasingly intricate, demanding a corresponding expansion in the parameters necessary for efficient analysis. Data acquisition, the systematic gathering of information regarding systems or procedures, involves automated collection from both analog and digital measurement sources such as sensors and..... Listed under: [Temperature Measurement Projects](#)



18. [Designing a Door Access Control System with Programmed AT89C52 Microcontroller](#) Abstract: Biometric door systems present limitations as they are unsuitable for widespread use due to hygiene concerns and accessibility issues for individuals with physical disabilities. To address these challenges, a novel approach was devised utilizing an AT89C52 microcontroller-based access door control system, integrating dual-factor authentication..... Listed under: [Microcontroller Programmer Projects](#)

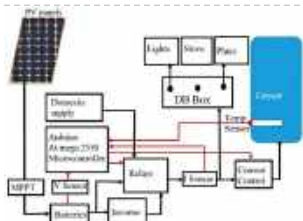

19. [Integrating Solar Power: Microcontroller-Based Approaches for Domestic Electricity](#) Abstract: Microcontrollers have found extensive application in endeavors aimed at reducing power consumption. The availability of microcontroller development tools has made them easily accessible. Many nations grapple with energy challenges such as insufficient power capacity and escalating energy demands. Consequently, it becomes imperative to introduce..... Listed under: [power - energy projects](#)

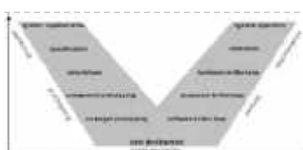

20. [Building Blocks for Success: A Structured Framework for Microchip PIC Microcontroller Applications](#) Abstract This paper introduces a framework designed for creating applications centered around a Microchip PIC microcontroller ( $\mu$ C). Comprising both hardware and software tools, this framework facilitates the development and transfer of



program code from a personal computer to the microcontroller, as well as the evaluation..... Listed under: [Other Projects](#)

21.  [Automated Room Temperature Monitoring System using Microcontrollers](#) Abstract Monitoring the temperature within a computer server room stands as a crucial responsibility to uphold the server's performance amidst potential disruptions caused by elevated room temperatures. This study details the development and implementation of a room temperature monitoring system based on a microcontroller. Utilizing..... Listed under: [Temperature Measurement Projects](#)
22.  [Enhancing Microcontroller Programming Skills through Multi-Module 8051 Microcontroller Boards](#) ABSTRACT In contemporary embedded systems, the microcontroller assumes a pivotal role. Mastery of microcontroller programming has become indispensable not only for engineering disciplines but also for various other fields such as computer science, electronics, and physics. Practical laboratory sessions have proven to be an effective..... Listed under: [Microcontroller Programmer Projects](#)
23.  [Efficient Power Generation with Microcontroller-Controlled Thermoelectric Generators](#) INTRODUCTION The global demand for electrical energy continues to rise steadily, necessitating a shift towards renewable energy sources as traditional fossil fuels like petroleum and coal become increasingly scarce and contribute to environmental pollution. Consequently, there has been a surge in research focused on harnessing..... Listed under: [Other Projects](#)
24.  [Efficient Multichannel Data Acquisition with USB Connectivity using PIC Microcontroller](#) 1. INTRODUCTION With the rapid advancements in embedded technology, there is a growing demand for a data acquisition system that combines fast processing speed, compact size, low cost, and real-time data monitoring capabilities. The utilization of a microcontroller as a processor has gained popularity due..... Listed under: [Interfacing\(USB - RS232 - I2c -ISP\) Projects](#)
25.  [Exploring the World of PIC Microcontrollers: An Architectural Overview](#) A Peripheral Interface Microcontroller (PIC), developed by General Instruments Microcontrollers in 1993, operates under software control and is programmed to execute various tasks, regulating production lines. PIC microcontrollers find application in diverse fields including smartphones, audio accessories, and cutting-edge medical devices. [caption id="attachment\_40304" align="aligncenter" width="300"]..... Listed under: [Other Projects](#)
26.  [Mastering the Basics: Programming a PIC Microcontroller](#) One lesson I've gleaned from parenthood is the formidable challenge of imparting knowledge to a child. Despite their keen interest and ample time and resources at hand, if a child isn't prepared or lacks essential foundational elements, grasping a skill or lesson can prove elusive..... Listed under: [Microcontroller Programmer Projects](#)
27.  [Innovative Robotics: A Comprehensive Project Exploration](#) A DC motor functions as an electromechanical device, translating electrical signals into mechanical movements. The rotation of the motor correlates directly with the applied input pulses, with the sequence of pulses determining the direction of the motor shaft's rotation. The speed of rotation is directly..... Listed under: [Robotics - Automation Projects](#)
28.  [An Integrated Approach to Developing Applications with Microchip PIC Microcontrollers](#) 1. Introduction In our daily lives, a variety of devices such as telephones, household appliances, and cars incorporate "smart" electronics, typically manifested as embedded systems. At their core, these systems involve a microcomputer designed to oversee specific processes within the application. Microcontrollers ( $\mu\text{C}$ ) or digital..... Listed under: [Development Board - Kits Projects](#)
29.  [Microcontroller-Driven AC Voltage Control with Soft Start Feature](#) 1. INTRODUCTION PWM-based AC voltage controllers find extensive application in uninterruptible power supplies (UPS) and high-power flexible AC transmission systems. This variable voltage output serves various purposes, including dimming street lights, adjusting heating temperatures in homes and industries, controlling the speed of fans and winding..... Listed under: [Development Board - Kits Projects](#)
30.  [PIC Microcontroller-Based IC Tester for Efficient Integrated Circuit Verification](#) 1. INTRODUCTION Within the electronics industry[1], as circuit complexity undergoes a drastic increase and the demand for higher reliability rises, a significant factor contributing to overall costs is the expense incurred during testing. Traditionally, distinct hardware circuits are required for testing different integrated circuits (ICs)..... Listed under: [Development Board - Kits Projects](#)
31.  [Advanced Techniques for Fault Detection, Indication, and Protection in Induction Motors](#) 1. INTRODUCTION The impact of microcontroller usage on our daily lives is remarkable. This versatile device is now prevalent in various control applications, utilizing a microprocessor as its central processing unit (CPU) while integrating features such as memory, timing references, and I/O peripherals on the..... Listed under: [Motor Projects](#)
32.  [Innovative Approaches to Control System Design for 100KV Impulse Generators](#) 1. INTRODUCTION An impulse generator is an electrical device designed to generate short-duration surges of high voltage or high current. Impulse signals are characterized by their very high magnitude and extremely brief duration. These impulses are typically utilized for insulation testing by passing them through..... Listed under: [Other Projects](#)
33. [Mastering PIC 24F Series: A Comprehensive Guide with MPLAB and Proteus](#) Introduction The field of embedded systems plays a crucial role in modern society, with a myriad of applications across various sectors such as telecommunication, medical devices, industrial control, and more (Miha & Mihael, 2008). Microcontrollers form the backbone of these embedded systems, capable of executing..... Listed under: [Other Projects](#)

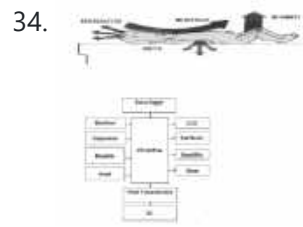
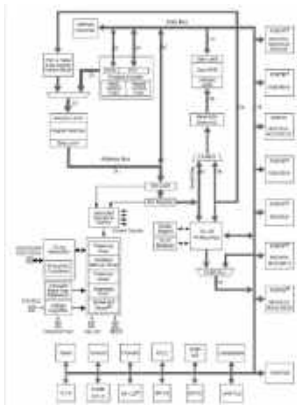

[Smart Baby Incubator: Enhancing Care with PIC Microcontrollers](#) INTRODUCTION Within the effective Baby Incubator system, the incubator serves as an infant-stimulation apparatus designed for the intensive care of newborns, particularly those who are premature or unwell. This system ensures a secure and hygienic environment, offering fresh air and sterile conditions essential for the..... Listed under: [Other Projects](#)

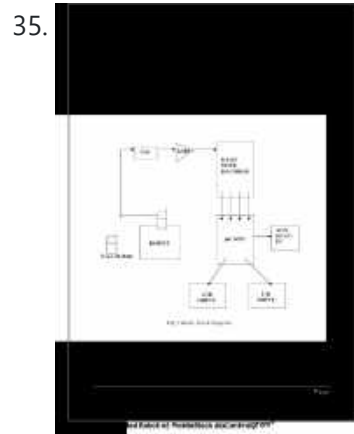

[Exploring Versatility: GSM-Based Robotic Vehicle Technology](#) Introduction To Robotics The term 'Robot' remains elusive, defying a precise definition due to its evolving usage. Initially, it referred to humanoid or human-like beings and originated from the Czech word meaning 'slave labor,' coined by Karel Čapek in his 1921 play, "Rossum's Universal Robots."..... Listed under: [Robotics - Automation Projects](#)

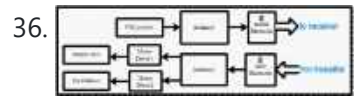

[Wireless Control of Robotic Arm via PS2 Joystick and Microcontroller Technology](#) 1. INTRODUCTION A robot is a machine capable of performing a multitude of tasks [1]. Specifically, a robotic arm, functioning as a robot rigger, exhibits the ability to execute various functions akin to a human arm. In industrial settings, these robotic arms undertake diverse tasks..... Listed under: [Robotics - Automation Projects](#)

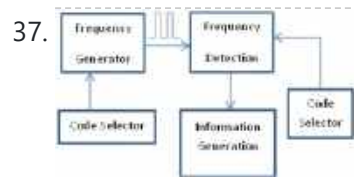

[Microcontroller-Based Laser Pulse Code Detection: Harnessing Pulse Repetition Frequency](#) This paper presents an enhanced system for detecting and tracking laser-guided weapons through a microcontroller-based decoding mechanism. The system utilizes a 4-quadrant laser detector to receive reflected pulses, and an electronic circuit processes these pulses. The processed data is then sent to a microcontroller for..... Listed under: [Other Projects](#)



[Precision Temperature Monitoring in Boiling Water with PIC Microcontroller](#) ABSTRACT In the industrial setting, accurately measuring the temperature of boiled water is a crucial undertaking. This paper presents the design and implementation of a temperature measurement system for boiled water utilizing a PIC microcontroller, specifically the PIC 18F452, and a temperature sensor from National..... Listed under: [Temperature Measurement Projects](#)

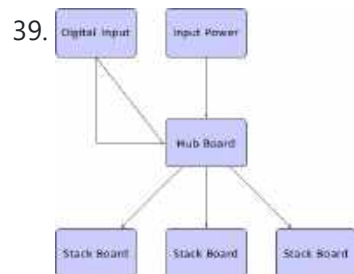

[Optimizing Performance: A Guide to Stacking Precision Power Supplies](#) 1. Introduction Statement of Purpose Our project selection stems from the recognition that power supplies represent a crucial and costly aspect of any electrical project. In an industrial context, numerous product test setups demand precision voltage references, but the acquired supplies often exceed the required..... Listed under: [power - energy projects](#)

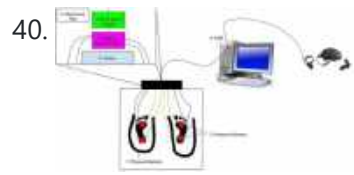

[A Comprehensive VR Disability Accessibility Design Document](#) Introduction Problem and solution overview As technological advancements propel the evolution of virtual reality (VR) devices, incorporating features such as full-body capture and haptic feedback, the potential for diverse applications in gaming, education, and resource management continues to grow. However, the current state of VR..... Listed under: [Other Projects](#)



[Intelligent Sips: Revolutionizing Dining with the SmartCup](#) Abstract The SmartCup Attachment is a comprehensive system designed for restaurants to monitor the liquid levels in their customers' cups. This system comprises the attachment affixed to the base of cups, a hub responsible for processing data from all cups and converting it into Bluetooth..... Listed under: [Wireless Projects](#)



[Programming HID Bootloader on PIC32](#) The bootloader enables program installation on the PIC32 without relying on an external programmer such as an ICD2, and it operates without the need for any drivers on the computer. Software PIC Source Code For every new program, it is necessary to establish a folder..... Listed under: [Microcontroller Programmer Projects](#)



[Hands-On Microcontroller Projects: BK300 Development Board Featuring PIC16F887 Chip Lab](#) 1. INTRODUCTION The study of microcontroller systems is experiencing a global surge across various fields within science, engineering, and technology departments of universities and polytechnics [1-2]. The utilization of microcontroller chips to oversee embedded system functions is witnessing rapid growth in daily technological design practices..... Listed under: [Development Board - Kits Projects](#)



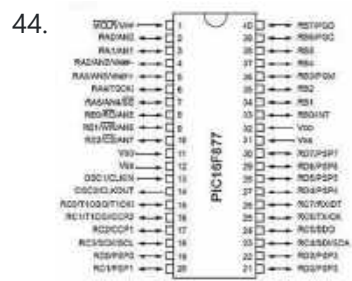

44. [Pitt Robotics Club's Guide to PIC16F877A Programming](#) The tutorials assume a foundational understanding of programming and electronics. If you're new to programming, it's advisable to grasp the basics of C or C++. Additionally, a basic knowledge of electronics and constructing simple circuits is recommended. Most of this information was gathered from the..... Listed under: [Robotics - Automation Projects](#)

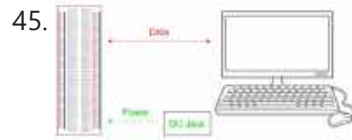

45. [The Digital Logic Smart Breadboard Experience](#) 1. Introduction 1.1 Problem and Solution In the realm of engineering prototyping, the breadboard stands as the primary choice for initial hardware testing. However, as the size of the prototyped system expands, such as in the case of a 4-bit calculator akin to the implementation..... Listed under: [Development Board - Kits Projects](#)



46. [Exploring Leon's Mini Random Number Generator \(mRNG\)](#) Sales Pitch Feeling overwhelmed by choices? Who isn't? Decision-making can be a maze. White, rye, or wheat? Pinstripes or polka dots? Feast or fast? But fret not—assistance is at hand! Enter the world's inaugural, handheld, portable decision-maker, fueled by genuinely random numbers. While my competitors..... Listed under: [Other Projects](#)

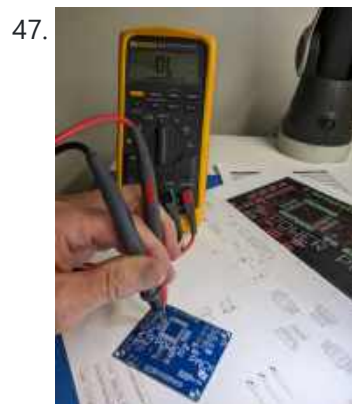

47. [Step-by-Step Assembly Guide for \[Development Board Name\]](#) Getting Ready Let's initiate by conducting a basic test to ensure the accurate manufacturing of your PCB - checking for any potential short circuits between the power and ground rails. Employ the bench digital multimeter to assess the resistance between Vcc and GND. Follow the..... Listed under: [Development Board - Kits Projects](#)



48. [Maximizing Wi-Fi Capabilities with the Explorer 16 Development Board](#) As society progresses, the necessity for wireless communication is evolving from a mere luxury to an essential requirement. Wi-Fi, extending beyond conventional internet communication, finds myriad applications. This guide delineates the functionalities inherent in the Microchip Explorer 16 Development Board for Wi-Fi operations. It also..... Listed under: [Wifi - WLAN Projects](#)



49. [Designing Your Ideal Alarm Clock: An Introduction to PIC18](#) Within this laboratory session, you'll employ the C language to create an alarm clock, delving into the implementation of "C" programs on the PIC18 microcontroller. Additionally, you'll gain insights into utilizing interrupts, executing digital-to-analog conversion, and incorporating music playback capabilities on the PIC18. This project..... Listed under: [Other Projects](#)



50. [Revolutionizing Wearable Tech: Advancements in Self-Powered Microchips](#) The potential for preventive healthcare could be driven by harnessing energy from body heat and movement. At the University of Virginia, researchers are crafting a low-power microchip capable of supporting real-time health monitoring directly on the body. This chip, fueled by sources such as body..... Listed under: [Microcontroller Programmer Projects](#)

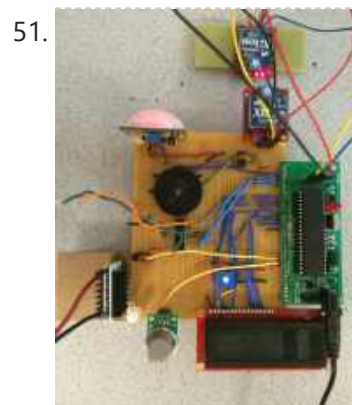

51. [Transform Your Home into a Smart Haven with DIY Wireless Automation](#) Introduction Smart home technology has grown tremendously in popularity over the last decade. A recent survey found that 46% of consumers view smart home features as an important consideration for their current or future residence. However, many commercial smart home systems are quite expensive to..... Listed under: [Wireless Projects](#)



52. [Audio Spectrum Analyzer](#) We developed an audio spectrum analyzer as our final project for ECE 4760. This analyzer presented a histogram-style representation of audio signals. We successfully achieved real-time display of the audio signal's frequency spectrum using a monochromatic histogram layout, where bins extended from left to right,..... Listed under: [Sound - Audio Projects](#)

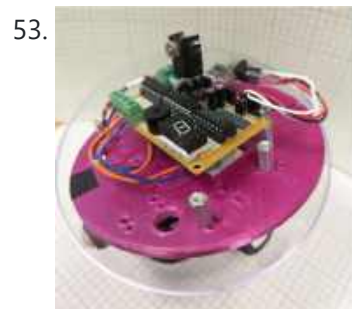

53. [Exploring the PIC16F88 Microcontroller for Remote-Controlled Robotics](#) I. Design Summary The objective of this mechatronics system design project is to develop a straightforward control and interface platform for robotics using a Microchip PIC processor. The aim is to create a versatile platform capable of accommodating various sensors, displays, and outputs, and it..... Listed under: [Robotics - Automation Projects](#)

54.  [Thermistor Respiratory Monitor](#) The concluding assignment in ECE 4760 involves the creation of a respiratory monitor tailored for use in resource-constrained settings. This device determines a patient's respiration rate by identifying temperature fluctuations as the patient breathes through a mask. Notable attributes of this device encompass an alarm..... Listed under: [Temperature Measurement Projects](#)
55.  [Video Project Development in the Midst of an Impromptu Online Semester](#) Receiving robot parts in the mail was an unexpected conclusion to the Winter 2020 semester for students. However, when faced with a unique situation, innovative solutions were required, and the instructors of EECS 373: Introduction to Embedded System Design rose to the challenge. With the..... Listed under: [Video - Camera - Imaging Projects](#)
56.  [Mastering the Art of Proportional-Derivative Control with Pulse-Width Modulation](#) Project Goals Upon completion of this project, you will have gained the ability to: 1. Regulate the velocity and direction of DC motors using an H-bridge circuit. 2. Execute and fine-tune a proportional-derivative control algorithm to sustain the desired orientation of the hovercraft. 3. Implement..... Listed under: [Motor Projects](#)
57.  [Crafting a Microcontroller Circuit: From Design to Programming](#) Official Assignment Description For this week's project, the task was to create a board, which was relatively straightforward once I got the hang of EAGLE's idiosyncrasies. Afterward, the challenge was to instruct the board to perform a specific task, a process that proved to be..... Listed under: [Microcontroller Programmer Projects](#)
58.  [Simulating the Water Cycle in a Desert](#) Abstract: The objective of my project is to create an automated watering system for succulent plants. In this project, an Arduino microcontroller is employed to periodically send a signal to activate a relay, which, in turn, powers a pump responsible for watering the plant. The..... Listed under: [Other Projects](#)
59.  [Basic Microcontroller Use for Measurement and Control](#) Introduction Measurement and control systems play a crucial role in the field of biosystems engineering. In the digital era, these systems are pervasive and essential, serving the dual purpose of gathering data (measurement) and automating processes (control). As an example, consider weather stations that measure..... Listed under: [Temperature Measurement Projects](#)
60.  [Stepper Motor Control using 8051 Microcontroller](#) I. Summary The core concept behind the project and its circuitry involves incrementally rotating a stepper motor by a specific step angle. To accomplish this, the project will employ an ULN2003 IC in conjunction with the L293D Motor Driver. This combination is necessary because the..... Listed under: [Motor Projects](#)
61.  [PIC MICROCONTROLLER BASED USB STORAGE](#) INTRODUCTION The primary objective of this project is to execute the USB protocol and manage the reading and writing of packets of various sizes within the memory of the Peripheral Interface Controller (PIC) microcontroller. Several test cases have been incorporated, which include: - Writing a..... Listed under: [Interfacing\(USB - RS232 - I2c -ISP\) Projects](#)
62.  [Pic Cross Development Support Tools](#) The SMALpic Assembler When I embarked on a substantial PIC-based project for paid work, I encountered a common issue: most of the PIC tools were designed exclusively for Windows. Additionally, the Linux tools available seemed to require a significant time investment to upgrade my outdated..... Listed under: [Development Board - Kits Projects](#)
63.  [Microcontroller Implementation of a Small Robot Arm Controller](#) Our senior project aims to design and develop assembly language for a small robot arm assembly controller, utilizing an enhanced 8051 microcontroller (80535). In addition to the controller's software, we will design and construct the microcontroller interface circuitry. Our investigation will focus on incorporating safety..... Listed under: [Robotics - Automation Projects](#)
64.  [Prototyping with Microcontrollers, Sensors, and Materials](#) Prototyping Prototyping involves the creation of an initial model of a product to conduct testing. Whether the product is intended for consumers, government entities, or businesses, it typically starts as a prototype, which may not include all the components or functionalities present in the final..... Listed under: [Sensor - Transducer - Detector Projects](#)
65.  [HOW TO PROGRAM A MICROCONTROLLER](#) INTRODUCTION: In the ever-changing contemporary society, technology is not only progressing rapidly but also becoming increasingly prevalent in our day-to-day existence. The emergence of "intelligent" items is significantly transforming the way we design almost every conceivable product. From shoes integrated with chips that sync with..... Listed under: [Microcontroller Programmer Projects](#)
66.  [IoT Microcontroller Development Kit](#) Our team developed an affordable microcontroller, which is open source and designed specifically for Internet of Things applications. Things used in this project Hardware components Texas Instruments LAUNCHXL-CC2650 SimpleLink CC2650 BLE Zigbee 6LoWPAN LaunchPad Texas Instruments BOOSTXL-CC2650MA SimpleLink BLE BoosterPack OSH Park Custom fabricated PCB..... Listed under: [Development Board - Kits Projects](#)
67. [LOW-COST I.MX 8M MINI SBC WITH ADVANCED VIDEO AND GRAPHICS CAPABILITIES](#) The MYS-8MMX Single Board Computer has a compact design with only 95mm by 65mm form factor. It is powered by NXP's first embedded multicore applications processor i.MX 8M Mini which features up to 1.8GHz quad-core ARM Cortex-A53 plus 400MHz Cortex-M4 processor, combining advanced 14LPC FinFET process technology to provide more speed and improved power..... Listed under: [Electronics News and Updates](#), [Game - Entertainment Projects](#), [GPS Based Projects](#)



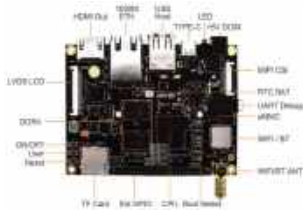

68. [Build this microcontroller controlled rainbow flying disc – and then throw it!](#) Hello all and welcome to this super simple and inexpensive instructable. If you like throwing frisbees AND you like flashing lights AND you like night time - then this instructable is for you! Have you ever waved a light or torch around and found that it 'draws' lines..... Listed under: [LED Projects](#)



69. [BATTERY CHARACTERIZER using PIC18F252](#) Introduction This circuit is a battery characterizer that applies a fixed load to a charged NiCad or NiMH cell and measures milliamp-hour capacity as it discharges. There is no single load that can be applied to a battery to measure milliamp-hours. It depends on the..... Listed under: [Battery Projects](#), [Projects](#)



70. [Determine capacitance by measuring the charging time using PIC16F688](#) When TEST button is pressed, RA3 pin is set to "1". R2 and R3 are divide the voltage to 1/2 Vra3 which is connected to RA2 pin to be a Vref for comparator. The C undertest is charging and the timer is start. When the..... Listed under: [Clock and Timer Projects](#), [Metering - Instrument Projects](#)

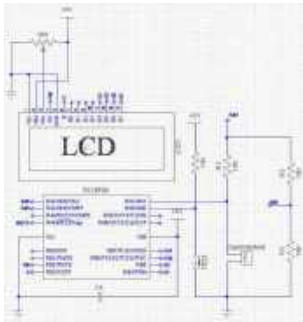

71. [PIC 12F675 Programmable 12V Battery Monitor](#) Being an active outdoor guy, I have a few different types of 12V lights and a variety of battery types. - For flying RC planes and quadcopters at night, we use sealed lead acid batteries to power our club tables. - For fishing, I have..... Listed under: [Battery Projects](#)



72. [Integrated Solar ChargeController, Inverter, PowerBank, Lamp](#) Microcontroller based Solar PV System's charge controller, inverter, PowerBank & LED lamp with menu-based navigation system on LCD display. Story About this Project I have a few solar panels, 12 Volt batteries, transformers and few more stuff laying around for a while crying out aloud..... Listed under: [Other Projects](#)



73. [RGB LED PWM Driver for High Power 350mA LEDs using PIC12F629](#) Description This project combines a PIC and three constant current 'buck' converters to produce an RGB LED controller that will operate with the the high power 350mA LEDs using PWM to control the LED brightness. By driving the red, green and blue LEDs with varying pulse..... Listed under: [LED Projects](#), [Projects](#), [PWM Projects](#)

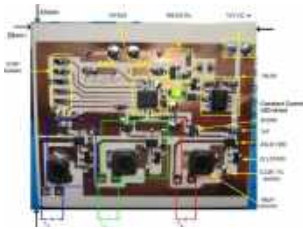

74. [Voice Activated Power Sockets \(Home Automation\)](#) Yet another voice controlled home automation system! As shown in the picture, the system can control any electrical appliance, by turning ON or OFF, that is connected into the electrical socket. The system does this using bespoke voice commands. The system uses a micro-controller board..... Listed under: [Home Automation Projects](#)



75. [Tiny ML for Big Hearts on an 8-bit Microcontroller](#) Predict the possibility of arrhythmias on an 8- bit Microcontroller, without sending the corresponding sensor data to the cloud. Story In the course of the pandemic, the interest in creating a 8- bit Microcontroller more innovative medical devices has run high, as recent years showed..... Listed under: [Other Projects](#)



76. [A digital thermometer or talk I2C to your atmel microcontroller using pic microcontroller](#) Abstract: The Atmega8 microcontroller from Atmel has plenty of digital and analog input/output lines. It is the ideal device to develop any kind of measurement equipment. In this article we see how to interconnect the microcontroller to a linux PC over a physical RS232 interface..... Listed under: [Microcontroller Programmer Projects](#)

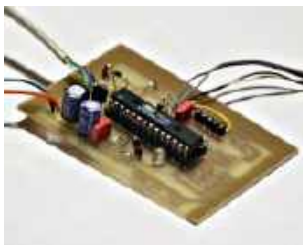

77. [Bluetooth Wireless Voltage Meter using Wiimote + Pic Chip + Autolt](#) In this tutorial I'm going to be showing you how you can send voltage values to your pc using a Pic chip, Wiimote, and Autoit3 scripting language. The process works by wiring a pic chip to the button pads of a wiimote. Then using the..... Listed under: [Wireless Projects](#)



78. [How to get started with TensorFlow Lite for Microcontrollers](#) Want to build your own TinyML application? This is a detailed approach to getting started with TensorFlow Lite for Microcontrollers! Story Introduction In the summer of 2022 I was selected to participate in the Google Summer

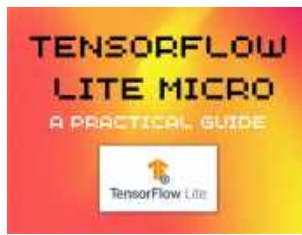

of Code (GSoC) under TensorFlow. While trying to build..... Listed under: [Other Projects](#)



79. [Programmable Stiffness Joint using pic-microcontroller](#) Team Members Amanda Care (Senior in Mechanical Engineering, Northwestern University) Eric Nickel (Graduate Student in Biomedical Engineering, Northwestern University, BS in Biomedical Engineering from the Milwaukee School of Engineering) James Yeung (Junior in Electrical Engineering, Northwestern University) Overview The "Programmable Stiffness Joint" is a device..... Listed under: [Microcontroller Programmer Projects](#)

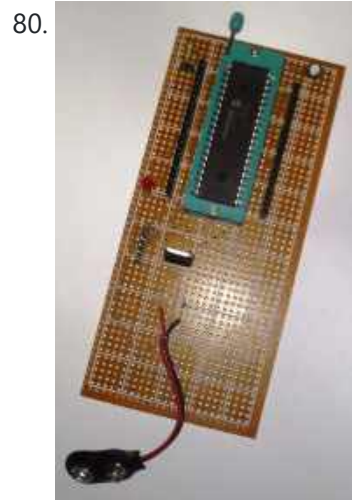

80. [PIC16F1787 Programmer Board \(for Almost all 40 pin 16Fxxx\)](#) Intro This is my first Instructable so I'm sorry for mistakes. Critics are always welcome 😊 So in this project I made a development board for PIC16F1787. Now most of you guys aren't familiar with this particular model. Some might even think why I chose..... Listed under: [Development Board - Kits Projects](#)



81. [Temperature Access Point Using an AVR® DA Microcontroller](#) Inspired by COVID-19 prevention, we have developed a system that measures the temperature of persons before they enter a building by Temperature Access Point Using an AVR® DA Microcontroller. Story about temperature Access Point During the pandemic, people are being asked to have temperature checked at..... Listed under: [Projects](#)



82. [chipKIT Tutorial 7: Using Nokia 5110 LCD](#) In Tutorial 4, we learnt interfacing an HD44780-based LCD to a chipKIT board for displaying alphanumeric output. Today, we will see how to connect a NOKIA 5110 graphical LCD (used in Nokia 5110 cell phones), which is a 84×48 pixel monochrome display of about 1.5" diagonal in size. The display..... Listed under: [chipKIT Projects](#), [Development Board - Kits Projects](#)

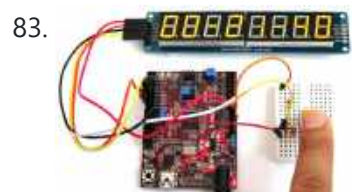

83. [chipKIT Project 5: Digital stopwatch on seven segment LED display](#) In this project, we will use the chipKIT Uno32 board to build a digital stopwatch capable of timing minutes, seconds, and 1/10th of seconds, and with a basic start and stop control feature. A MAX7219-driven 8-digit seven segment LED display is used to display the..... Listed under: [chipKIT Projects](#), [Development Board - Kits Projects](#)



84. [chipKIT Project 4: Digital light meter](#) A light meter is used to measure the intensity of illumination in a given area. It is widely used in schools, warehouses, factories, hospitals, office buildings, museums, art-galleries, parking garages, stadiums, and many more, to measure and maintain proper lighting levels. The intensity of illumination is usually expressed..... Listed under: [chipKIT Projects](#), [Development Board - Kits Projects](#)



85. [Metal Detecting with PIC18-Q71 Microcontroller](#) Distinguish between metal and non-metallic objects using Core Independent Peripherals (CIPs) with the Metal Detecting with PIC18-Q71 Microcontroller. Story about Metal Detecting with PIC18-Q71 This application creates a simple proximity metal detector with the Core Independent Peripherals (CIPs) in the PIC18-Q71 family of microcontrollers (MCUs) to differentiate between metallic..... Listed under: [Other Projects](#)



86. [Universal Driver & Dev Board using PIC16F](#) Description The simple 8 channel LED chaser has been a very popular project on Picprojects since it was first published a couple of years ago. During that time there has been a demand for a board that could drive more LEDs so I started designing..... Listed under: [Development Board - Kits Projects](#), [Projects](#)



87. [On-Board Satellite Controller using ARM Based Microcontroller](#) Satellite Subsystems Irrespective of the intended application, is it a communications satellite or a weather satellite or even an Earth observation satellite, different subsystems comprising a typical satellite include the following: Mechanical structure Propulsion Thermal control Power supply Tracking, telemetry and command Attitude and orbit..... Listed under: [Development Board - Kits Projects](#), [Wireless Projects](#)

88. [chipKIT Tutorial 1: Digital input and output](#) Our first chipKIT tutorial is about reading and writing digital data (0 or 1) from and to an I/O pin of the chipKIT board. Digital inputs are useful to determine whether an incoming digital signal is logic HIGH or logic LOW. A simple application of..... Listed under: [chipKIT Projects](#), [Development Board - Kits Projects](#)



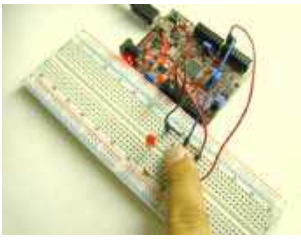

89.  [Tiny GNSS Module Interfacing With Microcontroller](#) Interfacing ultra-low power REYAX RYS8830 Tiny GNSS Module with Microcontroller. Story about Tiny GNSS Module while working with Tracking devices we need GPS Or GNSS receivers to get the geolocation details. These receivers must be precise by consuming low power, shouldn't have an external antenna, and..... Listed under: [Other Projects](#)
90.  [chipKIT Tutorial 2: Serial communication with PC](#) The PIC32 processor on the chipKIT Uno32 board provides two hardware serial ports. One of these is used by the on-board FTDI chip to create an USB-UART interface that allows the MPIDE tool running on the PC to communicate with the Uno32 board through an..... Listed under: [chipKIT Projects](#), [Development Board - Kits Projects](#)
91.  [What is Chipkit Development Board?](#) In order to understand the chipKIT platform, it is important to talk about Arduino first. Arduino is an easy-to-use and powerful open source environment for developing microcontroller based applications. Chipkit Development Board It has gained huge amount of popularity in past few years, specially among hobbyists..... Listed under: [chipKIT Projects](#), [Development Board - Kits Projects](#)
92.  [chipKIT Project 3: Easy Pulse Meter](#) This is a third project in our chipKIT tutorial series and today we are going to construct a simple pulse rate meter using our Easy Pulse sensor with Digilent's chipKIT Uno32 board. Digilent's chipKIT Basic I/O shield is also used in this project for displaying the pulse waveform..... Listed under: [chipKIT Projects](#), [Development Board - Kits Projects](#)
93.  [In-depth: TensorFlow Lite for Microcontrollers – Part 2](#) This blog details the inner workings of TensorFlow Lite for Microcontrollers and the role of Flatbuffers in them. Story of TensorFlow Lite for Microcontrollers Part 2/2: This blog extends my TensorFlow Lite for Microcontrollers tutorial. I was selected in Google Summer of Code, under TensorFlow, to work on..... Listed under: [Other Projects](#)
94.  [chipKIT Tutorial 6: Inter-Integrated Circuit \(I2C\) communication](#) I2C or IIC (Inter-Integrated Circuit) is a simple bidirectional serial interface, which requires only 2 signal lines for data transfer. It was originally developed by Philips in 1980's to provide easy on-board communications between a CPU and various peripheral chips in a TV set. Today,..... Listed under: [chipKIT Projects](#), [Development Board - Kits Projects](#)
95.  [chipKIT Tutorial 5: Pulse width modulation \(PWM\)](#) Pulse width modulation (PWM) is a technique of controlling the amount of power delivered to an electronic load using an on-off digital signal. The key idea behind this technique is that the average DC value of the digital signal, and hence the power delivered to..... Listed under: [chipKIT Projects](#), [Development Board - Kits Projects](#)
96.  [Voice Activated Robo Car on Microcontroller with TinyML](#) Using voice recognition with the in-built microphone, Wio Terminal (Voice Activated Robo Car) will be able to recognize the go, stop and background noise by TinyML. Story of Voice Activated Robo Car In this article, I will be making a voice activated Robo Car with the in-built..... Listed under: [Robotics - Automation Projects](#)
97.  [chipKIT Project 2: Temperature and relative humidity logger](#) This project is about building a PC-based temperature and relative humidity logger using the chipKIT Uno32 board and the DHT11 sensor. The project setup requires no additional wires (other than the USB cable) and components; the DHT11 sensor is directly plugged into four I/O pins..... Listed under: [chipKIT Projects](#), [Development Board - Kits Projects](#)
98.  [chipKIT Project 1: Digital thermometer using an LM34 sensor](#) In Tutorial 3, we learnt how to use chipKIT ADC channels to read an external analog voltage and convert it into a digital number. We also discussed about interfacing a standard Hitachi 44780-based character LCD to the chipKIT Uno32 board in Tutorial 4. Now it's..... Listed under: [chipKIT Projects](#), [Development Board - Kits Projects](#)
99.  [chipKIT Tutorial 4: Interfacing a character LCD](#) Liquid Crystal Displays (LCDs) are a very popular output device for displaying graphical and alphanumeric data in microcontroller based systems. They can also provide an interactive input interface to the users. The most common type of LCD controller used by hobbyists is the Hitachi 44780,..... Listed under: [chipKIT Projects](#), [Development Board - Kits Projects](#)
100. [chipKIT Tutorial 3: Analog-to-digital conversion](#) [caption id="attachment\_12035" align="alignnone" width="570"] Analog-to-digital conversion [caption] Theory Many embedded applications deal with physical variables such as motion, temperature, pressure, relative humidity,

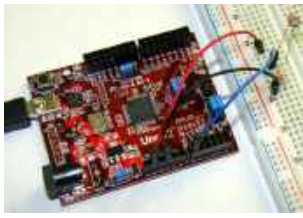

light intensity, and sound. A microcontroller cannot directly handle these entities because i) they are non-electrical signals, and, ii) they are analog quantities,..... Listed under: [chipKIT Projects](#), [Development Board - Kits Projects](#)

101.



[Pinguino Project: A PIC Microcontroller Based Arduino](#) This is a complete tutorial to make a PIC Microcontroller based Arduino. This is a complete tutorial to make PIC microcontroller based Arduino, which can run Arduino programs on PIC18F4550 or PIC18F2550 microcontroller, one advantage on this microcontroller is that it doesn't require any external programmers, since it has inbuilt..... Listed under: [Other Projects](#)

102.



[Frequency Counter by PIC16F628](#) In this project we are building a basic and low cost frequency counter circuit . It can measure from 16Hz to 100Hz signals with a maximum amplitude of 15V. The sensitivity is high, the resolution is 0.01Hz. The input signal can be a sine, a..... Listed under: [LCD Projects](#)

103.

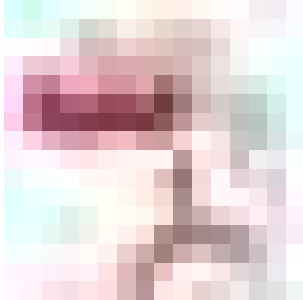

[Curiosity Development Kit Board](#) Satisfy Your Curiosity Your next embedded design idea has a new home. Curiosity is a cost-effective, fully integrated 8-bit development platform targeted at first-time users, Makers, and those seeking a feature-rich rapid prototyping board. Designed from the ground-up to take full advantage of Microchip's MPLAB..... Listed under: [Development Board - Kits Projects](#)

104.



[Keypad 4x5 for microcontrollers v. 1.1 using PIC16F877](#) What's this? The circuit here described is a simple 4x5 keypad that can be used in particular with the PIC 16F877 microcontroller, for which it has been designed considering a supply of 5V, 16F877 I/O pins leakage current, the voltage level recognized as a high..... Listed under: [Projects](#), [RTOS - OS Projects](#)

105.



[Frequency Meter Using Microcontroller](#) This tutorial simply states how to calculate frequency of a pulse source using a microcontroller. Story <https://youtu.be/NAoj-HLRlro> This tutorial simply states how to calculate frequency of a pulse source using a microcontroller. A high voltage level of pulse source is 3.3 V and low is..... Listed under: [Other Projects](#)

106.



[WHAT IS A PIC MICROCONTROLLER? WHAT CAN IT DO?](#) PIC microcontrollers ( Programmable Interface Controllers), are electronic circuits that can be programmed to carry out a vast range of tasks. They can be programmed to be timers or to control a production line and much more. They are found in most electronic devices such..... Listed under: [LCD Projects](#)

107.



[Programming SMD Microcontrollers Without Soldering](#) I failed in this wirelessly programming method, But I want to try more methods because finally, we are engineers. Story I tried to put my effort to program a single smd Arduino chip without soldering. But I get failed, and now I am here to..... Listed under: [Other Projects](#)

108.



[Infrared Remote Controlled \(RC\) Steerable Vibrobot Created by Naghi Sotoudeh](#) Vibrobots (and bristlebots) are simple robots that use a tiny pager / cellphone vibrator motor (with an eccentric weight) to randomly bounce around -- they are the subject of many Maker / DIY projects as well as some well-known commercial toys (such as the \$7.00..... Listed under: [Robotics - Automation Projects](#)

109.



[Remotely Controlled Microcontroller From a Browser](#) Interface with a microcontroller from a web browser, using HTTPS and a simple Python server. Story I love microcontrollers. I also love controlling hardware remotely, say, from another room of my house. The idea of being able to do this through a browser, like from..... Listed under: [Other Projects](#)

110.













[Ultrasonic Range Finder Circuit AD605 PIC16F876](#) Ultrasonic distance measurement, detection circuit pic16f876 microcontroller and ad605 (Dual Low Noise Variable Gain Amplifier singlesupply) integrated circuit diagrams used are C and asm software also Resimlredede oscilloscope's measurement. 40kHz ultra sonic transducers used as sensors. I2C Sonar Ultrasonic Range Finder In many embedded systems..... Listed under: [Development Board - Kits Projects](#)

111.



[Build a DIY Smart Watch Using Microcontroller](#) Introduction Wearables (Smart Watch) are becoming increasingly more prevalent in today's markets; however cost continues to limit the demand for such devices. My project aimed at producing a smartwatch with comparable functionalities to those available today. While running a total cost of less than \$100..... Listed under: [Other Projects](#)

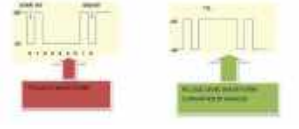

112.  [Amicus18: Arduino-style platform for PIC fans using PIC18F25K20](#) Arduino needs no introduction; it is an easy-to-use yet powerful open source embedded system development platform that has gained huge amount of popularity in past few years, specially among hobbyists. The standard hardware consists of an 8-bit Atmel AVR processor with on-board headers providing access..... Listed under: [Development Board - Kits Projects](#), [Projects](#)
- 
113.  [RS232 - Infra-Red Interface](#) Description This project is a Microchip PIC microcontroller with an RS232 serial interface on one side and an Infra-Red receive and transmit interface on the other. Important - All mention of RS232 on this page actually refers to RS232 waveforms operating at 5V TTL levels..... Listed under: [Interfacing\(USB - RS232 - I2c - ISP\) Projects](#)
- 
114.  [Instrument-Based Color Sonification with the PIC32](#) Sonification We created a system that can "see" colors in the environment and translate that data to interesting, fun musical instrument beats and patterns. Overview of the concept Sonification is the process of turning a collection of data into something that humans can hear. A..... Listed under: [Other Projects](#)
- 
115.  [Automotive Voltage Monitor using PIC12F683](#) Description Recently I got a new motorbike and on my second trip out, with only 50 miles on the clock the rectifier/regulator unit failed. The battery on a bike is pretty small and with the head light permanently on and all the ECU, ignition and..... Listed under: [Battery Projects](#), [Car Projects](#), [Projects](#)
- 
116.  [Audio CRO using PIC12F675 Microcontroller](#) This project is a miniature Audio CRO. For those not familiar with the abbreviation "CRO," it means "Cathode Ray Oscilloscope" and this is sometimes shortened to "SCOPE or O-Scope." A "CRO" is a piece of test equipment with a screen. It produces a visual indication..... Listed under: [Projects](#), [Sound - Audio Projects](#)
- 
117.  [Build a musical EKG with the Freescale FRDM-KL05](#) Short Introduction: I have been following the Battle of the DreamBoards Championship with interest and I enjoyed the variation of functionality features put together in each of the dreamboards. I especially had my attention attracted by the combination of audio inputs and outputs, analog to..... Listed under: [Sound - Audio Projects](#)
- 
118.  [BLUETOOTH LE BASED LCD MESSENGER USING STM32](#) The aim of this project is to send messages via Bluetooth using a web browser or smartphone to an LCD display that is connected to the STM32 board. 1. Introduction The project is based on STM32 Nucleo-144 which controls LCD display using BleuIO. For this project, we will need..... Listed under: [Bluetooth Projects](#)
- 
119.  [A new multi-function power supply unit for my Embedded Lab using PIC16F689](#) One important parameter in embedded system designing is power consumption. This parameter is directly related to the battery lifetime, if the system is to be powered from a battery. In order to determine the power rating of your designed system, you need to know how..... Listed under: [How To - DIY - Projects](#), [Projects](#)
- 
120.  [LED Scrolling Display Project Working With Circuit Diagram](#) We normally use a simple static LED display screen to convey a message. Earlier, when we want to display large data, we used to change message for every few instances. Now scrolling displays are more preferred to static. By using a pre programmed controller, we..... Listed under: [LED Projects](#)
- 
121.  [Serial Data Received from PC and Displayed on 16x2 Using USART of Pic16f877 Microcontroller](#) Here is a simple tutorial on how to receive serial data from PC(Personal Computer) Hyperterminal and display it on 16x2 lcd using PIC16f877 microcontroller. Its not much difficult you just need to know how to use USART(Universal Synchronous-Asynchronous receiver transmitter) of PIC 16f877. Serial data..... Listed under: [LCD Projects](#)
- 
122.  [TIC TAC TOE game using PIC16F628](#) This project is not to introduce Tic Tac Toe. Everyone knows this game. It's to introduce two features. Bi-coloured LEDs, microcontrollers and the skill of writing an ALGORITHM. You can use the project to learn the skills of creating the Tic Tac Toe program or..... Listed under: [Game - Entertainment Projects](#), [Projects](#)
- 
123.  [CELLPHONE OPERATED LAND ROVER](#) I know the general rule of world that "reading makes man ready, writing makes man everyday but practice makes man perfect." Only theoretical knowledge is not enough for an E.C (Electronics and communication engineering) student. A project is one of the subjects in which we have to..... Listed under: [Phone Projects](#)
- 
124. [Wireless controlled lightdimmer using PIC12F629](#) The meaning from this design is to build it in -i.e. a shaded lamp- and to switch this lamp on and off the normal way, just like it was switched before the dimmer was build in, then you could by exception dimming the lamp more..... Listed under: [Featured](#), [Home Automation Projects](#), [Internet - Ethernet - LAN Projects](#), [Projects](#)
-



125. [Simple mass storage for your microcontroller project](#) Do you want gigabytes of storage for your microcontroller? Would you like a simple way to transfer files from your PC to your picaxe or arduino or other micro project? This little projects demonstrates the uDrive that can be set up as an extra drive..... Listed under: [Interfacing\(USB - RS232 - I2c - ISP\) Projects](#)



126. [RFID Based Attendance System – Circuit, Working, Source Code](#) Attendance in colleges is generally paper based which may sometimes cause errors. Taking attendance manually consumes more time. So the proposed attendance system uses RFID technology to take attendance. In this system, each student is issued an RFID tag. Controlling unit is in the institute..... Listed under: [LCD Projects](#)

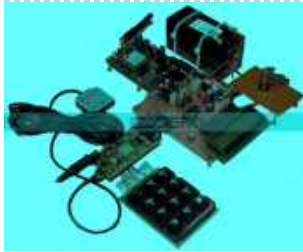

127. [Know the Procedure of GSM Modem Interfacing with 8051](#) The acronym of the GSM modem is Global System for Mobile Communications, it is a wireless communication module, used to make a computer or any processor to communicate over a network. This modem uses a variation of TDMA(Time Division Multiple Access) and is the most..... Listed under: [Interfacing\(USB - RS232 - I2c -ISP\) Projects](#)



128. [IN-8 single nixie tube clock using PIC16F84](#) After receiving one IN-8 tube from a friend (thanks), I decided to build myself a clock. This clock is more an ornament than a useful machine because it consists of just one digit (tube) so it displays current time every minute for three times. It..... Listed under: [Clock and Timer Projects](#)

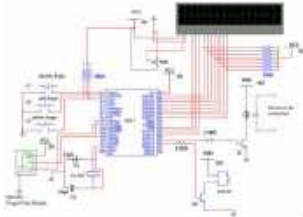

129. [Latest Microcontroller Based Electronic Project Circuits in 2014](#) A microcontroller is a small computer on a single integrated chip that is programmed to control the devices. Most of the embedded-based projects require knowledge about programming the microcontroller. Once students get an idea about the circuit, schematics and their operations, it becomes really easy..... Listed under: [Microcontroller Programmer Projects](#)

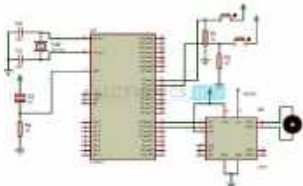

130. [Interfacing DC Motor with 8051 Microcontroller](#) When we talk about controlling the robot, the first thing comes into the mind is controlling DC motors. Interfacing DC motor to the microcontroller is very important concept in Robotic applications. By interfacing DC motor to the microcontroller, we can do many things like controlling..... Listed under: [Motor Projects](#)



131. [How to implement free running counter in PIC16F84A using seven segment display](#) This post provides the implementation of free running counter ( using c language ) for PIC16F84A micro-controller. This code is written in such a way that, the counter starts from a value of '0' ( displayed on the seven segment ) and then increments this..... Listed under: [LCD Projects](#), [Projects](#)

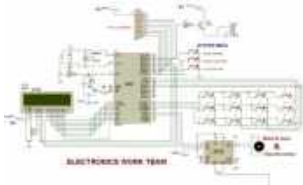

132. [8051 MICROCONTROLLER](#) 8051 Microcontroller based electronic locker system CIRCUIT DESCRIPTION Security is a prime concern in our day-to-day life. Everyone wants to be as much secure as possible.The issue of security is very paramount at home doors and safe. An access control for doors formsvital.link in a security..... Listed under: [LED Projects](#)



133. [PIC microcontroller power supply circuit by Chayapol](#) This is 5V portable power supply circuit for pic microcontroller experiments. or PIC microcontroller power supply circuit. As The PIC16F627A microcontroller use 5 volts DC power supply. My son need to build it as 5V portable power supply circuit, because of the need for safe..... Listed under: [Microcontroller Programmer Projects](#)

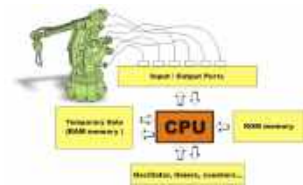















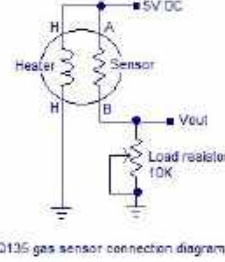



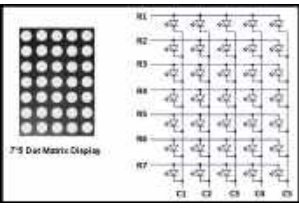

134. [Chapter 1: PIC16F887 Microcontroller – Device Overview](#) The PIC16F887 is one of the latest products from Microchip. It features all the components which modern microcontrollers normally have. For its low price, wide range of application, high quality and easy availability, it is an ideal solution in applications such as: the control of..... Listed under: [Memory - Storage Projects](#)



135. [PIC16F84A timer0 code and Proteus simulation](#) This post provides the timer0 code for PIC16F84A microcontroller. This code is written in C language using MPLAB with HI-TECH C compiler. You can download this code from the 'Downloads' section at the bottom of this page. It is assumed that you know how to blink an..... Listed under: [Clock and Timer Projects](#)

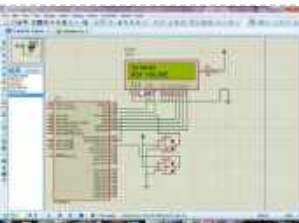

136.  [How to work with inbuilt ADC Module of PIC18F4550](#) A microcontroller, a digital device, can read, execute and transmit only digital signals. On the contrary, the outputs of the most of the transducers are analog in nature. Thus it is hard to interface these transducers directly with controllers. Analog-to-digital convertor (ADC) ICs are one..... Listed under: [Projects](#), [Sensor - Transducer - Detector Projects](#), [Tutorials](#)
137.  [Digital Temperature Sensor Circuit](#) Temperature sensors are widely used in electronic equipments to display the temperature. You can see the digital clock displaying the room temperature value. It is due to the temperature sensor embedded in it. Generally, temperature value is analog. It is converted to digital value and..... Listed under: [LED Projects](#)
138.  [Interfacing 7-Segment Display With PIC Microcontroller – MikroC](#) The 7-segment display is the earliest type of an electronic display that uses 7 LEDs bars arranged in a way that can be used show the numbers 0 - 9. (actually 8 segments if you count the decimal point, but the generic name adopted is..... Listed under: [Interfacing\(USB - RS232 - I2c -ISP\) Projects](#)
139.  [Air Sampler using PIC16F690 microcontroller](#) Do you ever wonder what is in the air you breathe? Or maybe you have hay fever and want to know what kind of pollen makes you sneeze in spring? Questions like that prompted me to build a simple device for capturing airborne particles so..... Listed under: [Medical - Health based Projects](#), [Projects](#)
140.  [Breadboard module for 18-pin PIC16F microcontrollers \(PCB version\)](#) Because of their compact size, ease of use and many built-in peripherals, the 18-pin PIC16F series processors (PIC16F628A, PIC16F88, and now PIC16F1827/47) have always been my favorite microcontrollers. Many of my projects and tutorials written in this blog also use PIC16F628A and PIC16F1827 microcontrollers. As..... Listed under: [How To - DIY - Projects](#), [Projects](#)
141.  [Password Based Door Lock System using 8051 Microcontroller](#) Traditional lock systems using mechanical lock and key mechanism are being replaced by new advanced techniques of locking system. These techniques are an integration of mechanical and electronic devices and highly intelligent. One of the prominent features of these innovative lock systems is their simplicity..... Listed under: [LED Projects](#)
142.  [Echo MP3 player using PIC18LF452](#) The EchoMp3 is a small DIY\* MP3 player. It's cheap and of excellent quality. 64, 128, 256, 512MB and 1, 2, 4 GB MMC and SD(HC) cards used as storage. FAT (FAT16) and FAT32 supported. Low power operation with a single AAA (HR03) 1V2 Ni-Mh..... Listed under: [How To - DIY - Projects](#), [Projects](#), [Sound - Audio Projects](#)
143.  [Breathalyzer circuit using 8051](#) Last Updated on March 12, 2014 by admin in 8051 projects with 15 Comments Alcohol Breathalyzer circuit using 8051 microcontroller (AT89S51). This article is about a breathalyzer circuit using 8051 microcontroller which outputs the blood alcohol content (BAC) from the breath. The BAC is..... Listed under: [Other Projects](#)
144.  [Tiny AVR Microcontroller Runs on a Fruit Battery](#) Some of the fruit and vegetables we eat can be used to make electricity. The electrolytes in many fruit and vegetables, together with electrodes made of various metals can be used to make primary cells. One of the most easily available vegetable, the ubiquitous lemon..... Listed under: [Battery Projects](#)
145.  [30 volts Panel Volt Meter Using PIC MCU](#) This is a simple application of internal 10-bit ADC(analog to digital converter) of PIC16F676 microcontroller.you can use this circuit to measure up to 30 v dc. the possible applications are on bench top power supply or as a panel meter in various system. Circuit description ..... Listed under: [LED Projects](#)
146.  [Interfacing DC Motor with PIC Microcontroller using L293D](#) DC Motor and L293D We can't drive a DC Motor (depends) directly with a Microcontroller, as DC Motors requires high current and high voltage than a Microcontroller can handle. Microcontrollers usually operates at +5 or +3.3V supply and it I/O pin can provide only up..... Listed under: [Motor Projects](#)

147.  [Interfacing Dot Matrix led Display with PIC Microcontroller](#) To know about Interfacing Dot Matrix led Display with PIC Microcontroller, we have to know about what is Dot Matrix Display? And how it work? Dot Matrix Display is an array of LED situated in a form of Matrix. See the architecture of a 7\*5..... Listed under: [LED Projects](#)
148.  [PIC Countdown Timer using PIC16f84a](#) Description : The purpose of this timer is to provide a countdown time from 1 second to 99 minutes & 59 seconds. I use it to control the lighting for the Ultra-Violet exposure of photosensitive PCB material. The project provides also an audible alarm at..... Listed under: [Clock and Timer Projects](#)
149.  [LED Character Moving English Font Display Project \(8x16\)](#) LED Character moving play Project is Very popularr and very valuable project in microcontroller field.In here we play English Language font on 8x16 play.You can Expand this 16 colun to up to 32 column.We use 16 LED columns and 8 LED Rows in this play.We use..... Listed under: [LED Projects](#)
150.  [PIC Development Board – Hello World Project](#) Hello friends, welcome to this exciting tutorial were we will begin our journey with latest PIC18F micros from Microchip Technologies. This tutorial will give you information on what software/hardware you will require and basic steps on how to get, install, configure and use them. After..... Listed under: [Development Board - Kits Projects](#)
151.  [Wave JT – Larson Scanner with Joule Thief](#) I love LED chasers. A bunch of LEDs neatly turning on and off on a precise timing - lights running one way, then the other way... It's relaxing, soothing, and hypnotic. There are so many LED chaser/scanner/sequencer circuits out there, some are made with discreet..... Listed under: [LED Projects](#)
152.  [DIY \\$1 PIC 12f675 JDM Programmer \(Cheap and Easy\)](#) Hi Everybody i am Again Doing something. and it is with PIC's! Almost Everybody do not want a Big Arduino in their projects or to control a rgb led with Arduino uno? Enjoy Compressing your projects with PIC and Attiny too. but in this wwe..... Listed under: [Development Board - Kits Projects](#)
153.  [Development board for Attiny84 Microcontroller](#) This is a development board for Attiny84 microcontroller. The Attiny84 chip has 11 pins addressable with the Arduino IDE, 8k of flash memory for program storage, and 512 bytes of RAM available for the stack and program variables. One feature of the Attiny84 that is..... Listed under: [Development Board - Kits Projects](#)
154.  [DIY Muscle Sensor / EMG Circuit for a Microcontroller](#) Measuring muscle activation via electric potential, referred to as electromyography (EMG) , has traditionally been used for medical research and diagnosis of neuromuscular disorders. However, with the advent of ever shrinking yet more powerful microcontrollers and integrated circuits, EMG circuits and sensors have found their..... Listed under: [Game - Entertainment Projects](#), [Robotics - Automation Projects](#)
155.  [PIC MicroController Volume Adjuster Program\(Proteus 8 Stimulation\)](#) Hello everyone, The important aspect of every learning is to induce curiosity and doing something meaningful to satisfy that.With the help of that curiosity, I'm here making a volume adjuster program which resembles the same in most devices but not that much, Here the default..... Listed under: [Sound - Audio Projects](#)
156.  [LEDs sync to music \(with pics of my awesome computer case mod\)](#) I'm finishing up my computer table i've been working on and one of the final touches is making LEDs sync to the speakers. I have some pics of my computer too. This project took me about 15 minutes and was free because i had the..... Listed under: [LED Projects](#)
157.  [How to get started with PICAXE 08M microcontroller](#) This is instructable for how to get started with PICAXE 08M microcontroller. To get started, you need: - 08M Protoboard or same kind of board (Can be homemade) - A LED - AXE027 USB Cable - 3V Power supply Step 1: Connect the led to..... Listed under: [Other Projects](#)
158. [Easy 16F84 Microcontroller Programmer – JDM](#) In this instructable , I 'll show you how I built and tested this simple yet powerful circuit . The JDM Programmer is my favorite Microcontroller programmer. It is a simple circuit and compatible with many software loaders. I 've built this circuit many years..... Listed under: [Microcontroller Programmer Projects](#)



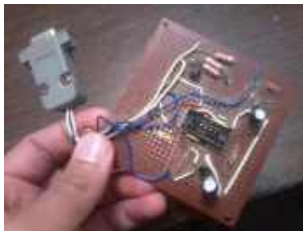

159.



[PIC 16F917 Gyroscope interface](#) In this post we will study the ADC ( Analog-to-Digital ) Module of the Microcontroller PIC16F917 . We will study a real circuit of PIC16F917 interfacing to a semiconductor Gyroscope. The Gyroscope is a motion sensor that senses tilt in a certain direction . The..... Listed under: [Interfacing\(USB - RS232 - I2c -ISP\) Projects](#)

160.

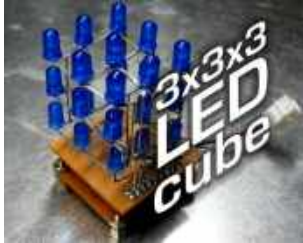

[PIC 3x3x3 LED cube](#) Here's my 3x3x3 LED cube, it's controlled by a PIC16F628A microcontroller. This is my first microcontroller project that finally works, so i suppose is not that difficult to make for beginners. I hope you'll enjoy that instructable and even make your own LED cube! [embed]https://youtu.be/eOM3cuapjpU[/embed]..... Listed under: [LED Projects](#)

161.



[Wireless Radio Frequency Module Using PIC Microcontroller](#) It's a Microcontroller Based DIY Electronics Project. Named Wireless RF Module Using PIC Microcontroller. The RF module is a small electronic circuit used to transmit, receive, or transceive radio waves on one of a number of carrier frequencies. RF modules are widely used in consumer..... Listed under: [Radio Projects](#)

162.



[Simple Button Keypad – Microcontroller](#) Simple method for creating a custom button keypad that doesn't require separate hardware. Just your microcontroller buttons a few resistors. What we have here is 9 buttons and 6 signal lines (3 inputs, 3 outputs). The basic setup is in a grid pattern where the three input..... Listed under: [Other Projects](#)

163.



[How to Interface LCD with PIC16F877A Slicker](#) PIC16F/18F Slicker Board The PIC16F/18F Slicker board is specifically designed to help students to master the required skills in the area of embedded systems. The kit is designed in such way that all the possible features of the microcontroller will be easily used by the..... Listed under: [Interfacing\(USB - RS232 - I2c -ISP\) Projects](#), [LCD Projects](#)

164.



[PIC16F84A LED blinking code + Proteus simulation](#) This post provides the code to make an LED blink using PIC16F84A microcontroller. This code is written in C language using MPLAB with HI-TECH C compiler. This code is intended to be the first step in learning how to use PIC16F84A microcontroller in your projects..... Listed under: [LED Projects](#)

165.



[Interfacing Temperature Sensor with Microchip PIC16F876A](#) The tutorial aims at providing the necessary information for interfacing an analog type temperature sensor with a Microchip PIC Microcontroller. PIC (Peripheral Interface Controllers) was introduced in 1985. The PIC16F876A has 8K of Flash Program Memory, 368 bytes of Data Memory (RAM) and many other..... Listed under: [Sensor - Transducer - Detector Projects](#)

166.



[Schematic design with the PIC16F84A microcontroller](#) Many circuits on the Internet are built with a CD4017 counter IC. I myself chose to use a microcontroller for this job: the PIC16F84A. A microcontroller increases the complexity but it allows you to build a very flexible light computer. The circuit can be kept..... Listed under: [LED Projects](#)











167.





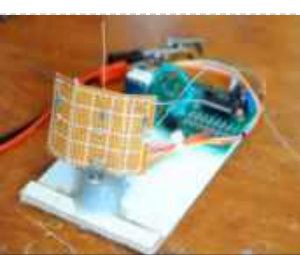

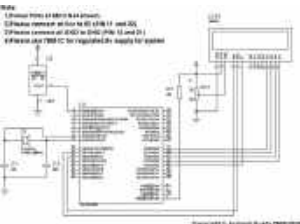



[Navigation Lights for Models for PIC12F629](#) Description This project was inspired from a post on the Picprojects forum where a member had adapted the RGB Moodlight project for use as a strobe and beacon for a model aircraft. I thought this would be of interest to others so I've put this..... Listed under: [LED Projects](#), [Projects](#)

168. [EnvStick USB Temperature Sensor using PIC12F683](#) The EnvStick is cheap, homemade temperature sensor that plugs into a USB port. It provides a simple way to collect a room's ambient temperature. I made it for fun. EnvStick Features: - Temp sensor (+/- .5 deg C) - USB 2.0 - Windows/Linux software -..... Listed under: [Interfacing\(USB - RS232 - I2c -ISP\) Projects](#), [Projects](#), [Sensor - Transducer - Detector Projects](#)



169.  [Fire Fighting Robotic Vehicle](#) We all are well aware of the major fire accidents that frequently take place in nuclear power plants, petroleum refineries, gas tanks, chemical factories and other large scale industrial units and result in very serious consequences. Thousands of people have lost their lives due to..... Listed under: [Robotics - Automation Projects](#)
170.  [Digital thermometer with PIC16F84 circuit](#) This electronic project is a very simple thermometer that is based on the PIC16F84A microcontroller, designed by Microchip. Why to use a thermometer that is designed using a microcontroller and not a classic analog thermometer? Because you can design a complex solution using few external..... Listed under: [Metering - Instrument Projects](#)
171.  [Text in the air with PIC16F84](#) Writing LEDs air Today, most electronic systems with complex functions, micro-controllers are designed using. Easily programlanabilmeleri, prices to be cheaper and less due to external hardware requirements microcontrollers have an important place in the field of electronics. For example, Series produced by the company Microchip..... Listed under: [LED Projects](#)
172.  [Tens Electronic Muscle Stimulation Device Circuit with PIC16F84](#) Television for a period, Frequently electronic muscle stimulation device radio advertising saw the state of the PIC16F84 microcontroller gerçekleştirilmiş I used to be very similar to the device onarmıştım had a microcontroller pic16f series and the circuit is very simple example of a useful in..... Listed under: [Development Board - Kits Projects](#)
173.  [Unipolar Stepper Motor Control Circuit with PIC16F877](#) Hello friends, this article, unipolar stepper motor control circuit related work. The purpose of this circuit is connected to unpolar stepper motor I designed buttons, select the number of steps we determined the direction, speed, and with it a system that implements the step motor..... Listed under: [Motor Projects](#)
174.  [DC Motor Speed Control using Microcontroller PIC-16F877A](#) Micro-controller is a very widely used electronic component and today we are showing your another example of it. Today's' project topic is "DC motor speed control using Microcontroller PIC16F877A" and we are sharing full project report of it. This is a very good project work..... Listed under: [Motor Projects](#)
175.  [Single-Axis PIC Controlled Solar Tracker DIY Kit using PIC18F1220](#) Single-Axis PIC Controlled Solar Tracker DIY Kit Hi All I'm not going into as much depth with this instructable due to my current time constraints. That said, I fully plan on updating this instructable as time progresses with new algorithms and programs for optimization. Intro:..... Listed under: [Other Projects](#), [Projects](#)
176.  [Shrieker using PIC16F676 Microcontroller](#) Recently a cell phone ring tone was in the news - it's 17,000 Hertz and meant to be heard by teenagers, but inaudible to adults. Really got some people upset for some reason. It got me wondering - what frequencies can I hear? I made..... Listed under: [Projects](#), [Sound - Audio Projects](#)
177.  [Temperature Indicator using PIC microcontroller](#) Hi friends, today we will see how to make temperature indicator using PIC microcontroller. The basic aim of this project is make you familiar with PIC microcontroller. It also explains how LM35 and 7 segment displays can be interfaced with PIC microcontroller. Components required: Following..... Listed under: [Temperature Measurement Projects](#)
178.  [Interfacing LM35 Temperature Sensor with PIC Microcontroller.](#) The are many cool sensors available now a days, ranging from IR distance sensor modules, accelerometers, humidity sensors, temperature sensors and many many more(gas sensors, alcohol sensor, motion sensors, touch screens). Many of these are analog in nature. That means they give a voltage output..... Listed under: [Robotics - Automation Projects](#), [Sensor - Transducer - Detector Projects](#)
179.  [2-Wire LCD Interface using PIC16C84](#) Alphanumeric LCD displays have become very popular for microcontroller applications because they can add a lot to a project in a variety of different ways. A text message giving the user instructions as well as feedback can make the application seem much more "professional" and..... Listed under: [LCD Projects](#), [Projects](#)

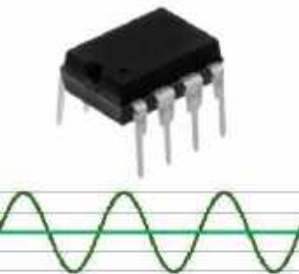
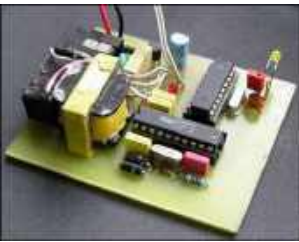

180.  [Voltage, Temperature & Frequency Meter With PIC Micro controller](#) Features... Voltage, Temperature and Frequency can switching to each others using push buttons. Voltage Meter can measure DC voltage between 0v to 50v. Frequency Meter can measure frequency up to 65KHz. Temperature Meter can use between 00C to 1500C. Every functions can paused using push..... Listed under: [Temperature Measurement Projects](#)
181.  [Digital Count Down Timer using PIC Microcontroller](#) In this article, our author Mithun has developed a 0 – 99 min counter using PIC microcontroller 16F628A. So basically this is a digital count down timer ideal for engineering and diploma students for their project requirements. We have given complete circuit diagram of the..... Listed under: [Clock and Timer Projects](#)
182.  [Low Resource Microcontroller – 3 Phase BLDC Motor Speed Controller](#) This could form the basis where high performance is not required This article focuses on a minimal resource microcontroller implementation for a 3 phase BLDC motor, closed loop speed motor controller application based on a Microchip PIC12 device. It shows how minimisation techniques can reduce..... Listed under: [Motor Projects](#)
183.  [PIC16F877A timer0 code + Proteus simulation](#) This PIC16F877A microcontroller tutorial answers the question, " How to use timer0 of PIC16F877A and how to handle its interrupts? " Using PIC16 simulator (Proteus) you can verify this PIC timer0 code and change it according to your needs. This code is written in C language..... Listed under: [LED Projects](#)
184.  [Interfacing xbee with PIC microcontroller using MikroC](#) In this tutorial, I will show how to interface an xbee module with PIC microcontroller. Here MikroC Pro for PIC compiler is used to write the code. Xbee modules communicates with host devices using serial communication. Most of the PIC microcontroller have UART module to support serial..... Listed under: [Interfacing\(USB - RS232 - I2c -ISP\) Projects](#)
185.  [Getting started with PIC18F Microcontrollers](#) After writing quite a bit of experimental tutorials on PIC16F series of microcontrollers, I thought of moving forward to the enhanced-range family of PIC microcontrollers, the PIC18F, which was introduced by Microchip in late 90s. Although PIC16F series are excellent general purpose microcontrollers, certain limitations..... Listed under: [Interfacing\(USB - RS232 - I2c -ISP\) Projects](#)
186.  [PIC 12F675 Microcontroller Tutorial.](#) A tutorial on the 12F675 PIC microcontroller which shows you how to program and use it with a series of projects starting out with a simple LED flasher and progressing on to more advanced projects. To use the tutorial files you need to have a PIC..... Listed under: [LED Projects](#)
187.  [Digital Barometer using PIC Microcontroller and MPX4115A Pressure Sensor – XC8](#) The Motorola MPX4115A is an atmospheric pressure sensor powered by 5V and delivers and output from ~0.25V to ~4.75V based on the pressure detected at room temperature (25°C). The device provides a linear output based on pressure. As the pressure rises, the output voltage of..... Listed under: [Robotics - Automation Projects](#), [Sensor - Transducer - Detector Projects](#)
188.  [Metal detector robot using pic microcontroller](#) This project describes hardware and software I have developed which allows a small 8 bit PIC microprocessor to function as a single frequency detector or tone decoder. Such a circuit can be used to detect the presence of a certain frequency within an analog signal,..... Listed under: [Robotics - Automation Projects](#), [Sensor - Transducer - Detector Projects](#)
189.  [Alarm Phone Dialer with MT8880 and PIC 16F84A](#) Just hook this Alarm Phone Dialer up to something you would like to monitor, for example, a high water alarm, low temperature alarm, back window, garage door, etc. When the system is activated it will call a number of programmed numbers to let you know..... Listed under: [Phone Projects](#)
190.  [Fire Fighting Controlling Robots Used in Dangerous Situations](#) Robots can be used in many applications in industries, military, domestic. One of the major uses of Robots is an asset to human beings. Whether it is any kind of hazardous situations like a fire breaking out or a place full of landmines, Robots can..... Listed under: [Robotics - Automation Projects](#)
191.  [Speed Synchronization of Multiple Motors In Industries using PIC Microcontroller](#) The aim of this project is synchronization of multiple motors using wireless technology. This project uses radio frequency to synchronize motor speeds. This is applicable to many industries like textile mills, steel plants, and paper plants wherein all the motors used on conveyor are desired..... Listed under: [Motor Projects](#)
192. [Mini project board for PIC12F series microcontrollers](#) The 12F series of PIC microcontrollers are handy little 8-pin devices designed for small embedded applications that do not require too many I/O resources, and where small size is advantageous. These applications include a wide range of everyday products such as hair dryers, electric toothbrushes,..... Listed under: [Development Board - Kits Projects](#), [Projects](#)

193. 

[Interfacing LCD with PIC Microcontroller – CCS C](#) In this tutorial we will see How to interface a 16×2 character LCD Module with PIC 16F877A Microcontroller using CCS C Compiler. 16×2 character LCD is a very commonly used LCD module in electronic projects and products. 16×2 means it can display 2 rows of..... Listed under: [LCD Projects](#)

194.



[Up-Down counter on 16\\*2 LCD using 8051 microcontroller](#) DESCRIPTION In this circuit 16\*2 lcd IS used to show the value of count using 8051 microcontroller. The maximum value of count is 99 because. In this circuit we are using 8051-microcontroller, 16\*2 lcd, 2 switches for up counting button & down counting button. Data..... Listed under: [LCD Projects](#), [Microcontroller Programmer Projects](#)

195.



[Ionization Smoke-Detector With Programmable Calibration](#) Microchip Technology unveiled the RE46C180—the world's first Ionization Smoke-Detector IC with programmable calibration and programmable feature selection, and the first with horn synchronization and auto alarm locate. This Ionization Smoke-Detector ASIC also has expanded options for implementing hush operation, and more options for interconnect operation—including..... Listed under: [Sensor - Transducer - Detector Projects](#)

196. 

[IRMimic2™ Trainable IR Remote Control Transmitter with Macros](#) Features: Simple to train - Can learn up to 57 commands, and each can be in a different format/protocol Two different operating modes - Keypad or MCU interface Supports up to 32 keys in keypad mode Any key can be a macro (multiple command sequence)..... Listed under: [Wireless Projects](#)

197.



[PIC Microcontroller Based Electronic Lock](#) Security is a prime concern in our day-today life. Everyone wants to be as much secure as possible. An access control for doors forms a vital link in a security chain. The microcontroller based digital lock for Doors is an access control system that allows..... Listed under: [LCD Projects](#)

198.



[rtc microcontroller](#) Interfacing an SPI-Interface RTC with a PIC Microcontroller - Maxim Application note describing how to interface an SPI-interface RTC with a PIC microcontroller. . PIC, real time clock, RTC, spi interface, pic microcontroller . -> Using a D Interfacing an SPI-Interface RTC with a PIC..... Listed under: [Interfacing\(USB - RS232 - I2c -ISP\) Projects](#)

199.



[Complete Circuit Board Lab & POV Business Card using PIC12F508 microcontroller](#) Complete Circuit Board Lab & POV Business Card Introduction Though there are many Instructables on some aspect of how to make circuit boards, this one is different. It's an instructable on how to make the things you need to make circuit boards, specifically, a flamboyant..... Listed under: [Development Board - Kits Projects](#), [Projects](#)

200.



[Mouse interfacing and communication using PIC16F877](#) Introduction On this page a circuit is described, making it possible to interface a PIC and a PS/2 mouse. If you send me a request (read further), it is possible to obtain for free also the assembler program to communicate with the PS/2 mouse. The..... Listed under: [Interfacing\(USB - RS232 - I2c -ISP\) Projects](#), [Projects](#)

201.

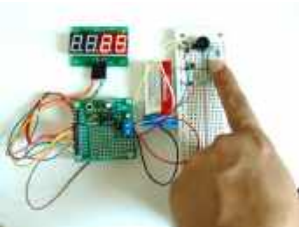









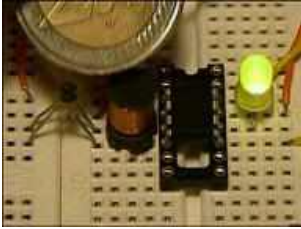

[0-9999 seconds count down timer using PIC12F683 microcontroller](#) The goal of this project is to construct a simple 0-9999 seconds count down timer with an alarm and a display. The time is set through two tact switches and the count down seconds are displayed on a 4-digit seven segment LED display. The project..... Listed under: [Clock and Timer Projects](#), [LED Projects](#)











202.



[PIC16F877 i2c code and Proteus simulation](#) This post provides the i2c code (using the i2c module built in the hardware[1]) for PIC16F877 microcontroller. This code is written in C language using MPLAB with HI-TECH C compiler. You can download this code from the 'Downloads' section at the bottom of this page. It is assumed that..... Listed under: [Interfacing\(USB - RS232 - I2c -ISP\) Projects](#), [Projects](#)

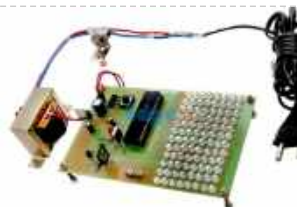

203.  [Projects on Speed Checker To Detect Rash Driving On Highways](#) While driving on highways, drivers should not exceed the maximum speed limit permitted for their vehicle. However, accidents keep on occurring due to speed violations as drivers follow their speedometers and control their speed according to them, and reduce the speed if they find it to be..... Listed under: [Metering - Instrument Projects](#)
204.  [PicoDetector : a PIC-based simple and cheap metal detector](#) A short video clip is sometimes better than a long explanation : The idea of this circuit is to hack PIC oscillator circuit, by replacing the crystal by a coil : the frequency of the oscillator then depends on presence of metal near the coil, just like..... Listed under: [LED Projects](#)
205.  [PIC16f628 DS18B20 Adjustable thermometer circuit](#) A friend of mine and I want to share with you what I did to set the thermostat circuit. As I used the circuit temperature sensor Ds18B20. 3-digit, 7 shows the screen with digit. Please note that the range of 0 to 99.9. When the..... Listed under: [Development Board - Kits Projects](#)
206.  [Rotary Encoder Interfacing with PIC Mirocontroller](#) i am currently working with some power supply design and i can say using conventional pots(potentiometer) and rotary switch to adjust the voltage and other stuff is quite old school. so i have decided to go for a bit high tech , actually bit digital. so here..... Listed under: [Interfacing\(USB - RS232 - I2c -ISP\) Projects](#)
207.  [PIC16F877A LED blink](#) The Microchip PIC16F877A has 40 pins 33 of them can be input or output. In this simple project I am going to configure this microcontroller to blink a 33 LED each LED is connected to one I/O pin. The PIC16F877A has 8 analog channels, so..... Listed under: [LED Projects](#)
208.  [Big 7-segment Digital Clock](#) Using only 2 capacitors, 3 resistors, 4 BIG seven-segment Display, 1 xtal, 2 switches ,and 1 Microcontroller PIC, you can build this Digital Led Clock main circuit. you can use common anode or common cathode display, just select the display type. Here is the pinout..... Listed under: [Clock and Timer Projects](#)
209.  [RC5 Protocol Remote Control Decoder](#) This project shows how to decode IR remote controls which uses Philips RC5 protocol with microchip PIC16F84A microcontroller. You can find details about RC5 on Wikipedia Related topics: Philips RC5 & LG TV Remote Control Decoder IR Remote Control Based On PIC Microcontroller The RC5 ..... Listed under: [Wireless Projects](#)
210.  [PIC16F877 timer1 code and Proteus simulation](#) This PIC16F877 microcontroller tutorial answers the question, " How to use timer1 of PIC16F877 and how to handle its interrupts? " Using PIC16 simulator (Proteus) you can verify this PIC timer1 code and change it according to your needs. This code is written in C language..... Listed under: [Projects](#)
211.  [Pic Projects With Schematics And Source Code](#) Circuit-Zone.com - Electronic Projects, Electronic - Project list | pic microcontroller, »circuit digital clock using pic16f628a microcontroller schematics » they act only ones – right then, when it's really necessary » how to burn or program pic. Electronics projects circuits, Electroschematics.com: over 1050 top electronics..... Listed under: [LCD Projects](#)
212.  [Analog Input Using PIC Microcontroller \(assembly Language\)](#) So this tutorial should show you how to get an analog input using a PIC microcontroller (I'm using a PIC16f887) in assembly language. You may have a demo board (which makes programming way easier) just a chip. I'm using just a plain 40 pin chip..... Listed under: [Microcontroller Programmer Projects](#)
213.  [Solar energy measurement using pic microcontroller](#) In this post we will discuss about the Solar energy measurement using pic microcontroller: The solar energy marketplace is one of the most quickly growing renewable energy advertise in the United States. Currently, we have seen an important enhancement in requirements for remote monitoring and..... Listed under: [power - energy projects](#)
214.  [USB Human Interface Device Communication with PIC Microcontroller – MikroC](#) Figure 1: USB Communication Circuit Diagram The HID device class code is "0x03, this class is used for devices operated by human, devices like keyboard, mouse, joystick and so forth. The advantage of HID devices is that, they don't require to install drivers, in most..... Listed under: [Interfacing\(USB - RS232 - I2c -ISP\) Projects](#)

215.  [Digital Ammeter circuit using pic microcontroller](#) In this project we have a tendency to design a circuit to build an electronic voltmeter while not making use of any microcontroller. Here we have a tendency to employing a very moderate IC for voltage activity particularly ICL7107/CS7107. Making use of ICL7107, we are..... Listed under: [Metering - Instrument Projects](#)
- 
216.  [USB NEC Infra-Red Transmitter and Receiver](#) This project is a spin-off of another project I am working on and since there is a Remote Control 2017 contest on Instructables I thought I post this project. So if you like this project, please vote for it. Thanks. As you may know, I..... Listed under: [Other Projects](#)
- 
217.  [Darkroom Timer using PIC16F84 microcontroller](#) Source Code for PIC16F84 and CD4511 decoder Also, there is an updated version with NPN drivers replacing the 4511 and many new features by Brendon Archibald [websales optusnet.com.au] DARKROOM TIMER The purpose of this project is to present a device that is useful and..... Listed under: [Clock and Timer Projects](#)
- 
218.  [Top PIC Microcontroller Projects with Embedded C Programming](#) Peripheral Interface controller (PIC) family is one of the most powerful advanced microcontroller which is developed by the microchip technology with Harvard architecture, i.e., it has a minimum set of instructions. The PIC microcontroller projects are programmed with the embedded C programming language. PIC devices..... Listed under: [Microcontroller Programmer Projects](#)
- 
219.  [MOTION SENSOR USING PIR SENSOR MODULE WITH PIC MICROCONTROLLER AND WITHOUT MICROCONTROLLER](#) The circuit diagram is quite simple. I have powered my circuit with 4 AA batteries that gives 6 V supply. A diode is used in series to drop the voltage down to 5.4 V as the operating voltage for the PIC microcontroller should be below..... Listed under: [Sensor - Transducer - Detector Projects](#)
- 
220.  [1. Serial interfacing LCD with Pic Microcontroller](#) Parallel interfacing LCD with MCU at least need 6 I/O pins (4 bit mode) and maximum can up to 11 I/O pins (8 bit mode). The I/O pin can be cut down to 3 pin by serial interfacing using shift register. They were few shift..... Listed under: [LCD Projects](#)
- 
221.  [Bluetooth Controlled- Obstacle Avoidance Robot Car Using PIC32 Microcontroller](#) "Robot-Car: Design Fused with Obstacle Avoidance Technology" Recently, there is an intensive research undertaken in the field of intelligence robotics and autonomous mobile robot applications. Through the this project we wanted to explore this field by building a robot car that can potentially avoid the..... Listed under: [Robotics - Automation Projects](#)
- 
222.  [Speed Control of DC Motor using Microcontroller by using PWM ECE Project](#) This is a good Electronic project report on Speed Control of DC Motor using Microcontroller by using PWM. In this system, a micro controller is interfaced with a LCD, Keypad and DC motor driver. The Micro controller is used for controlling the DC motor by..... Listed under: [Motor Projects](#)
- 
223.  [Password Based Circuit Breaker using PIC Microcontroller with C code](#) Here i am going to explain you a simple Password based circuit Breaker Project using PIC Microcontroller. This project is much similar to my previous one, "Password Based Door Locking System". Circuit breakers are electromechanical devices used in the power system to connect or disconnect..... Listed under: [Development Board - Kits Projects](#)
- 
224.  [HD44780 16x2 Char LCD Interfacing with microcontroller](#) Project Description:- In this project we are going to learn various things about this chip set and displaying text on this LCD. The HD44780 16x2 char LCD screen Use 8bit and 4 bit parallel interface with backlight. This Primary Objective in this project are:- 1. Displaying "Hello Word!!..... Listed under: [Interfacing\(USB - RS232 - I2c -ISP\) Projects](#), [LCD Projects](#)
- 
225.  [Strobe Lights Project](#) Stroboscopic effects of lights for nightclubs are realized by bringing into play old white Light Emitting Diodes (LEDs) swapping the ejection lanterns/lamps for superior effectiveness at minimal cost. This control is achievable by instantaneously changing the Light Emitting Diodes on & off at elevated volts..... Listed under: [LED Projects](#)
- 
226. [Home Security System with GSM Using 8051 Microcontroller](#) Security is a big challenge everywhere because thefts are increasing day by day owing to the unsafe and insecure security systems in homes, commercial complexes and industries. Several conventional technologies are





available to keep home properties safe from intruders, but most common smart home security..... Listed under: [Home Automation Projects](#), [Security - Safety Projects](#)



227. [How to interface RFID with PIC18F4550 Microcontroller](#) RFID (Radio Frequency Identification and Detection) is widely used everywhere from highly secured defense laboratories to school attendance system. By employing RFID, much secured entry systems can be developed without incurring huge costs. These are the reasons of excessive use of RFID technology. In this..... Listed under: [How To - DIY - Projects](#), [Projects](#), [RFID - NFC Projects](#), [Tutorials](#)

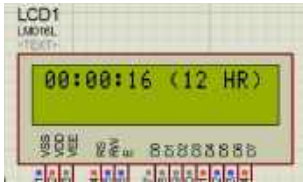

228. [Digital Clock Using Microcontroller 89C52/89S52](#) Are you a beginner in micro controller projects?and are you stuck where to start from?if yes,then this is one of the simplest mini projects that you can start from . This mini project will give you a clear understanding of programming your micro controller. we..... Listed under: [Clock and Timer Projects](#)



229. [Line following Robotic Vehicle using Microcontroller](#) The project is designed to develop a robotic vehicle that follows a specific path. This project uses a microcontroller of 8051 family for its operation. A pair of photo sensors comprising IR transmitter and photo diode is interfaced to the controller to detect the specified..... Listed under: [Robotics - Automation Projects](#)



230. [PIC 16F88 Microcontroller PIC based Tengu](#) Tengu derives its name from a mythical Japanese creature known for getting into mischief. Our Tengu, however is more earthly in nature. It responds to voice and sounds and takes on different facial features depending on the intensity of the sound. If no sound is heard for some..... Listed under: [LED Projects](#)

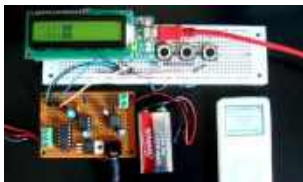

231. [LM386 based stereo audio amplifier with digital volume control using PIC18F2550](#) Due to its simplicity (requires minimum external components) and high availability, LM386 is very popular among hobbyists for use in low-voltage audio amplification applications. Most of the time a potentiometer is used at the input side of LM386 to provide a volume control in the..... Listed under: [Projects](#), [Sound - Audio Projects](#)



232. [Microchip PIC Serial Port Programmer](#) About the Programmer This is a Simple com port based Microchip PIC microcontroller Programmer,This Programmer is based on JDM programmer.The entire programmer is built around commonly available components Features Does not support the usb to serial converter. Works with most of PIC mcu. Works with 18F2550..... Listed under: [Microcontroller Programmer Projects](#)



233. [How to Build your Own USB PIC Programmer?](#) This DIY PIC programmer is a continuation of our PIC programming basics tutorial. By using this USB PIC programmer, you can program microchip PIC series of 10F, 12F, 16F, 18F, 24F, 30F. This is also an EEPROM programmer as it supports 12Cxx EEPROM. The main..... Listed under: [Interfacing\(USB - RS232 - I2c -ISP\) Projects](#)



234. [Serial Controlled RGB LED PWM Driver PIC12F629 based PWM controller for RGB LEDs](#) Description If you want to build your own multiple RGB LED display that you can control from either a PC or a dedicated controller then this project will let you do just that. The project on this page came about when while I was developing..... Listed under: [LED Projects](#), [Projects](#), [PWM Projects](#)



235. [\[Simple\] Generating Pulse Width Modulation using PIC Microcontroller – Mikro C & Proteus Simulation](#) How to generate Pulse Width Modulation (PWM) using PIC microcontroller? This is going to be a continuation of our microcontroller online tutorial series. This article covers the detailed explanation and simulation of PWM generation using PIC16F877A microcontroller.What is a Pulse Width Modulator? A PWM has series of..... Listed under: [PWM Projects](#)



236. [PWM DC Motor Speed Controller Circuit Using PIC16F877A Microcontroller](#) In our last PIC online tutorial we have covered PWM generation using PIC Microcontroller. As I told earlier PWM has wide application in electronics and robotics engineering.In this article I'm gonna show you one of the important applications of PWM in Robotics, it is called..... Listed under: [Motor Projects](#)



237. [Lazer Duel](#) For our ECE 4760 final project, we designed and built a Lazer Duel game system involving two guns and a base station commucating over ultra low power RF transceivers. We can shoot and detect shooting using an IR emitter/receiver on the guns. The base station will coordinate the game by allowing two..... Listed under: [LED Projects](#)

238. [DC Motor Interfacing With PIC Microcontroller Using L293 Motor Driver IC](#) L293d is an H Bridge bidirectional motor driver IC used to interface DC motor and stepper motors to Microcontrollers. CircuitsGallery.com already discussed about the working principle of L293 IC with an



example of bidirectional motor driver circuit. It is very easy to make a DC motor..... Listed under: [Interfacing\(USB - RS232 - I2c -ISP\) Projects](#)

239.



[GSM Based Digital Wireless Notice Board Using PIC16F877A Microcontroller](#) Are you looking for Final year Electronics Engineering Project? Here CircuitsGallery presents GSM based electronics and telecommunication engineering projects for students. You can submit this as your academic project. Our project is nothing but a GSM based notice board using PIC that is capable of displaying..... Listed under: [Wireless Projects](#)

240.



[Interfacing GPS Receiver with 8051 Microcontroller -AT89C52](#) How to interface GPS receiver with 8051 (AT89C52)? GPS receiver is an electronics device capable of receiving Global Positioning System (GPS) signals to decide the device's location on Earth. Today GPS receiver is popular in vehicles and other navigation equipment. As we know that GPS..... Listed under: [Interfacing\(USB - RS232 - I2c -ISP\) Projects](#)

241.



[PIC16CXXX real time clock electronic project](#) A very simple real time clock electronic project can be designed using the PIC16CXXX microcontroller family, designed by Microchip Technology. This real time clock electronic project uses the Timer1 module, from a mid-range PIC16CXXX microcontroller, to control a low-power real-time clock. Timer1 was..... Listed under: [Clock and Timer Projects](#)

242.



[Home Automation and Security System using Microcontroller ATMEGA8 with Arduino Programming](#) Home automation and security systems have become very popular these days, today industrial automation techniques are widely adopted by luxurious homes and apartments. Here I'm going to give a worthy home automation security and monitoring project for engineering students. On the whole this microcontroller based..... Listed under: [Home Automation Projects](#)

243.



[Digital DC Power supply using PWM with PIC microcontroller](#) In our lab I saw many DC power supply which have a variable knob to regulate the output. I was dreaming to make such a project where I can regulate the voltage using push button. As I am not an industrial level expert so this project..... Listed under: [PWM Projects](#)

244.



[Introducing Easy Pulse: A DIY photoplethysmographic sensor for measuring heart rate](#) When I first built the Heart rate measurement through fingertip project, the infrared LED and photodiode used for finger photoplethysmography were actually from salvaged parts, and therefore, I could not provide specifications for them in the article. As a result of that it takes quite a bit..... Listed under: [Medical - Health based Projects, Projects, Sensor - Transducer - Detector Projects](#)

245.



[Vehicle Theft Control System by Using GSM and GPS Systems](#) At the present time, the rate of crime is increasing rapidly because it is a kind of evident from the actual fact that thefts became a matter of routine. Particularly these vehicles may incur huge losses on the part of the amount invested on these..... Listed under: [GPS Based Projects](#)

246.



[Tampered Energy Meter Monitoring Conveyed to Control Room by GSM with User Programmable Number Features](#) The main concept of this project is to reduce the power theft by using an integrated energy meter such that whenever an energy meter is tampered, it sends an alert message to the concerned authorities through the GSM modem for indicating power theft. Day by..... Listed under: [Metering - Instrument Projects](#)

247.



[NETWORK EQUIPMENT RESETTER using PIC16F628](#) Introduction This program is a network power resetter. It controls a solid-state-relay that is in series with 110VAC that supplies power to a satellite internet receiver, various routers, etc. Once every 24 hours it drops power for 10 seconds to allow the receiver and routers..... Listed under: [Internet - Ethernet - LAN Projects, Projects](#)

248.

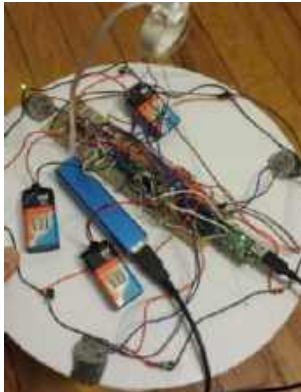

[Blimp-F-O is a remote-controlled flying machine designed with a PIC32 microprocessor.](#) Introduction Flying drones have a wide range of applications and are becoming more and more popular. With that in mind, we decided to construct a balloon copter capable of fluid navigation in any direction. At the same time, we wanted our design to be reliable..... Listed under: [Phone Projects](#)

249. [Naked Clock using PIC16F877 Microcontroller](#) Why have an enclosure? The enclosure of a clock doesn't tell you the time! So I built this PIC clock with no part that doesn't serve an electrical function. The hanger is the ground. The microcontroller is the 40-pin PIC 16F877. I set it up,..... Listed under: [Projects](#)





250. [Converting a Proxxon MF70 Milling Machine To CNC – 2 using PIC18F4620](#) My layout is shown below. It may not be as intuitive or informative as the layout on a PC display, but contains everything I have found necessary for control of the Mill. (and previously the DRO's on my other Milling Machine and Lathe.) I should..... Listed under: [CNC Machines Projects](#), [Projects](#)



251. [Bicycle Persistence of Vision Light Display using PIC16F84](#) In February of 2007 I spent a little while prototyping a board that turns any bicycle wheel into a moving display billboard using a single string of LEDs. The idea was to do something that would be very visible, turn itself on and off automatically,..... Listed under: [Game - Entertainment Projects](#), [Home Automation Projects](#), [LED Projects](#), [Projects](#)



252. [Speech Recognition Eye Test](#) For our final project we implemented a speech recognition eye test that is capable of performing the entire Snellen eye test on its own. It starts by displaying large letters and waits on the user to guess which letter has been displayed. The user speaks..... Listed under: [Medical - Health based Projects](#)



253. [Servo Motor Controller using PIC12F629](#) This project controls two servo motors - both clockwise and anticlockwise and has variable speed. You can use the Joy Stick to "pan and tilt" a remote camera or provide "left-right-up-down" action for a crane or an animation on your model layout. The project also..... Listed under: [Motor Projects](#), [Projects](#)

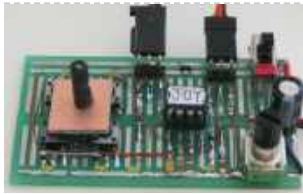

254. [USB and PIC Microprocessors 16C745 and 18F2455](#) Introduction This page describes a project a colleague and I completed between September, 2000 and March, 2001 as part of the Engineering Physics degree program at the University of British Columbia. In summary this project involved building a USB device using the PIC 16C745 microprocessor..... Listed under: [How To - DIY - Projects](#), [Interfacing\(USB - RS232 - I2c -ISP\) Projects](#), [Projects](#)



255. [Using an LCD's for Graphics Animation using PIC16C84](#) This project uses Myke's 2-Wire LCD Interface from last week and will help teach you "Graphics Animation" using LCD's. Last week, I showed how the PICMicro could be connected up to a Hitachi 44780 LCD using only two wires. This week, I wanted to use..... Listed under: [LCD Projects](#), [Projects](#)



256. [A PIC16F819 DYMOCLOCK](#) I wanted to build a clock as simple as possible : built around a little 18 pins PIC no 7 segment display, only LEDs no decoder, no buffer, no driver for the LED display a cheap temperature sensor The solution of direct LED driving comes..... Listed under: [LED Projects](#)



257. [Interactive Blitz Chess: A Physical Blitz Chess Board Powered with PIC32](#) Introduction We created a companion system for physical chess boards to help players enjoy their fast paced blitz game with a chess clock, a visual board to keep track of the game, a display for available moves based off of what piece that players want..... Listed under: [Game - Entertainment Projects](#)



258. [Making a binary clock using a PIC16F88](#) You can use a PIC microcontroller and an LED matrix to create a binary clock (or if you prefer you can wire up individual LEDs). This project uses an LED matrix block as it saves lots of wiring. So what is it ? Its an..... Listed under: [Clock and Timer Projects](#)



259. [dsPIC30F2012 breadboard](#) Bernard introduces us to the dsPIC microcontroller. He shows us his Arduino like project board for a dsPIC and gives advice on software development tools. This article was submitted by Bernard Klinc as part of the "Hobby parts for articles" program. Bernard received a graphic..... Listed under: [Development Board - Kits Projects](#), [Projects](#)



260. [FTS-8 subtone encoder](#) Many Yaesu transceivers from the 1990s and thereabouts could use an optional FTS-8 module, that provided subtone generation for transmission, and subtone decoding for CTCSS reception. One of the radios that used this module was the FT-736 multiband, multimode full-duplex VHF-UHF rig. I bought one..... Listed under: [Home Automation Projects](#)

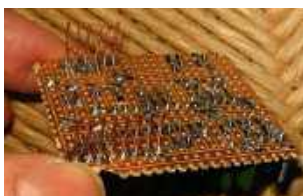

261. [Hand Sign Lock](#) Introduction Security using technology is a growing and expanding field to protect against the user's identity or property. As more advanced tools are developed, security has begun to expand to utilize a person's physiology as a key instead of a password; for example, newer models..... Listed under: [Security - Safety Projects](#)



262.



[Arduino to PIC Communication using PIC18LF4520](#) One very common thing in electronics is the need for two intelligent devices to communicate with each other. When you first see a PIC and Arduino you might think that they are two different systems and don't share much in common, but you'd be wrong!..... Listed under: [Interfacing\(USB - RS232 - I2c -ISP\) Projects, Projects](#)

263.



[Voice controlled wheelchair](#) The Project aims at controlling a wheelchair for handicaps by means of human voice. The speech recognition system is a useful way of implementation and is easy to use programmable speech recognition circuit. Programmable, in the sense that user can train the words (or vocal..... Listed under: [Sound - Audio Projects](#)

264.



[Two way Simple Very Small Telephone Exchange](#) This is a very small telephone exchange attached only two ordinary Tele phones. Fully bi-directional facility with an intercom system. When a phone is in off hook condition , Exchange will detect it & send ringing pulse to other phone. When it will be picked..... Listed under: [Phone Projects](#)

265.



[How to interface keypad with PIC12F675](#) This post provides a simple method to interface any keypad (e-g 4x4 or 4x3 etc) with PIC12F675 microcontroller. The code for PIC12F675 is written in C language using MPLAB with HI-TECH C compiler. You can download this code from the 'Downloads' section at the bottom of this..... Listed under: [Interfacing\(USB - RS232 - I2c -ISP\) Projects, Projects](#)

266.

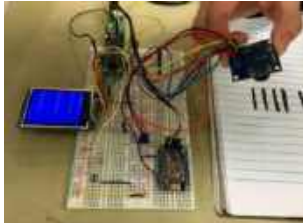

[Barcode Scanner](#) Introduction In our final project, we used CMOS camera to identify interval binary 0 and 1 sequence represented by black and white bars. Then, we used WIFI module to transmit the sequence to personal computer and displayed it on a web page. In our projects,..... Listed under: [Other Projects](#)

267.



[PIC16c71 four channel digital voltmeter](#) This electronic circuit project is a simple four channel digital voltmeter with display and keyboard . This four channel digital voltmeter is based on PIC16C71 manufactured by Microchip Technology . The PIC16C71 device's I/O ports have an improved sink/source specification. Each I/O pin can sink..... Listed under: [Metering - Instrument Projects](#)

268.

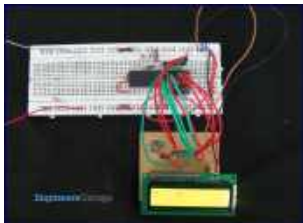

[PIC16F84A LCD interfacing code \(In 4bit mode\) and Proteus simulation](#) This post provides the LCD[1] interfacing code in 4bit mode using PIC16F84A microcontroller. This code is written in C language using MPLAB with HI-TECH C compiler. You can download this code from the 'Downloads' section at the bottom of this page. It is assumed that you know how to make an..... Listed under: [Interfacing\(USB - RS232 - I2c -ISP\) Projects, LCD Projects, Projects](#)

269.



[How to display custom characters on LCD using PIC16F84A](#) This post explains the idea of creating custom characters on any LCD ( e-g on 16x2 LCD ) which has HD44780U controller in it. Almost all 16x2 or 20x2 LCDs have HD44780U controller in them[1]. This controller provides the functionality of CGRAM ( Character Generator..... Listed under: [LCD Projects, Projects](#)

270.



[15x7 Display using a PIC16F628 Microcontroller](#) This project is what you have been waiting for. Remember the scrolling signs you see in shops and on advertising billboards? Now you can program your own moving sign with all the effects you can think of. We have provided a blank canvas in the..... Listed under: [LED Projects, Projects](#)

271.



[Wake-U-Up System](#) This project is aimed to design a 'Sleep and Wake-up Assistant'. Different from a normal alarm clocks which can only make noise, this alarm clock is designed to wake up a person in a comfortable and effective way by involving sound, light stimulation, motion detection..... Listed under: [LED Projects](#)



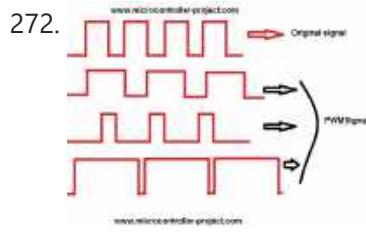

272. [DC motor and Fan speed control using pic 16f877 Microcontroller](#) Here is a simple project on how to control fan or dc motor speed using pic 16f877 microcontroller. There are numerous ways to control the speed of motor(or fan). Varying current,voltage and resistance etc. But when it comes to controlling the speed using microcontrollers. Then..... Listed under: [Motor Projects](#)

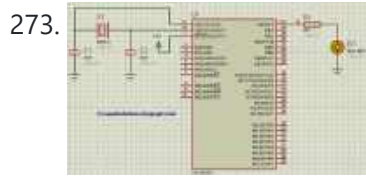

273. [PIC16F877 LED blinking code and Proteus simulation](#) This post provides the code to make an LED blink using PIC16F877 microcontroller. This code is written in C language using MPLAB with HI-TECH C compiler. This code is intended to be the first step in learning how to use PIC16F877 microcontroller in your projects. You can..... Listed under: [Game - Entertainment Projects](#), [LED Projects](#), [Projects](#)

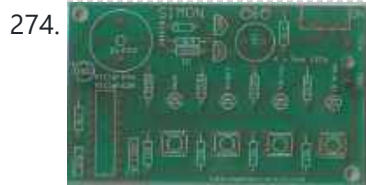

274. [A memory game using a PIC16F84A microcontroller](#) This article describes a game we all know. It is SIMON. It uses 4 switches, 4 colored lights and a speaker to produce a sequence of tones and flashes that has to be repeated. After each correct sequence, the computer adds another tone with its..... Listed under: [Game - Entertainment Projects](#), [Projects](#)

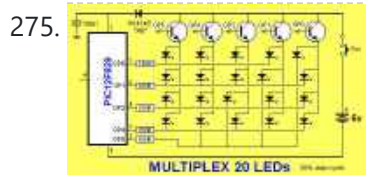

275. [20 LED BADGE using PIC12F629 Microcontroller](#) This project drives a number of LEDs via a very clever circuit. There are 3 ways to drive a LED from an output of a micro. The simplest is called "dump." This is where the LED is connected directly to the output via a resistor..... Listed under: [LED Projects](#), [Projects](#)



276. [Displaying Images on Graphical Lcd\(JHD12864E\) using Pic16f877 Microcontroller](#) Here in this post i am going to teach you how to display images on Graphical lcd using Pic Microcontroller(16F877). I am using JHD12864E graphical Lcd in my Project. JHD12864E is 128x64 dimension lcd. 128x64 means it has 128 columns and 64 rows. So total dots it..... Listed under: [LCD Projects](#)



277. [Clicker Clone](#) This project aims to implement a protocol-compatible iClicker substitute to provide students with a cheaper alternative to in-class polling while allowing the university to keep its existing investment. High Level Design Rationale Our motivation from this project comes from our personal experience. iClickers are inconvenient..... Listed under: [Bluetooth Projects](#)

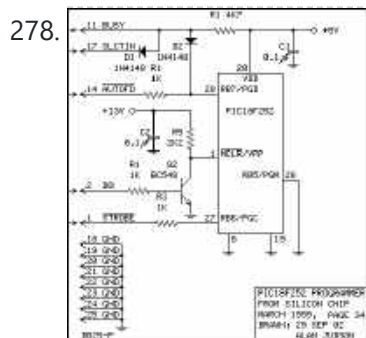

278. [PIC18F252 Programming](#) 1. Introduction This investigation was started after I ordered the free sample kit for the Circuit Cellar contest, called Mad Dash for Flash Cash. There seems to be many ways to program the device. Here I have investigated two ways of programming the PIC18F252. 2..... Listed under: [Microcontroller Programmer Projects](#)



279. [Getting Started with MPLAB XC8 Compiler – LED Blinking](#) In this tutorial we will learn How to Blink an LED with PIC Microcontroller using MPAB XC8 Compiler. Recently Microchip released a series of development tools including MPLAB X IDE and MPAB XC Compilers. MPLAB X IDE is a software that runs on a computer..... Listed under: [LED Projects](#)





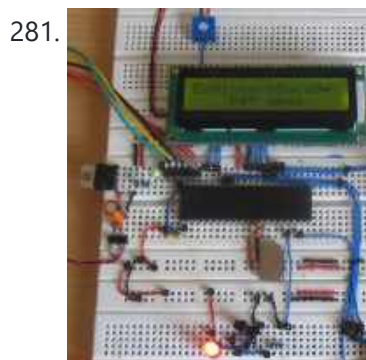





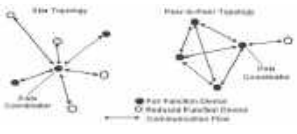

280. [Digital "Etch A Sketch" Glove](#) Introduction For our ECE 4760 final project, we designed, constructed, and tested a glove-operated system that dynamically simulates the classic toy, Etch A Sketch, on a TFT LCD screen. In deciding what to build, our team wanted to create a device that would utilize several..... Listed under: [Other Projects](#)



281. [How to Glow an LED using PWM with PIC Microcontroller](#) Pulse Width Modulation (PWM) is a technique in which the width of a pulse is modulated keeping the time period of the wave constant. One cycle has a fixed time period called 'Period' and a varying on time called 'Duty cycle'. The entire wave can..... Listed under: [LED Projects](#)



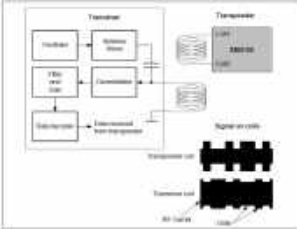







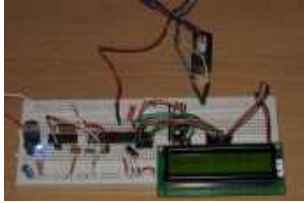



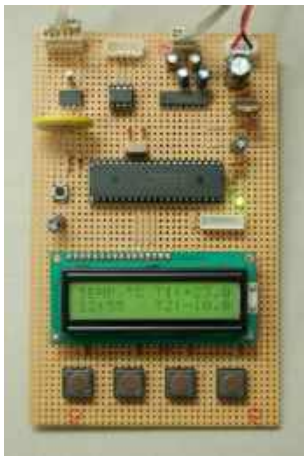



282. [3 LED Bike Light for PIC10F200](#) Description This project is a multi-function LED bike (cycle) light using 3 LEDs. It is based on a PIC10F200 baseline microcontroller, running from a supply voltage of 2 to 5 volts. In standby mode it consumes a current of less than 1µA making it perfect..... Listed under: [Home Automation Projects](#), [LED Projects](#), [Projects](#)

283.  [Online Monitoring of Temperature of Conductors Using Zigbee and GSM](#) Project Summary An on-line monitoring system of temperature of conductors and fittings based on GSM SMS and Zigbee is produced in this project, by which the temperature of conductors and fittings can be monitored in real-time and some accidents caused by the increased temperature can..... Listed under: [Temperature Measurement Projects](#)
284.  [Android App Home Automation via Bluetooth Using PIC16F628A Microcontroller](#) We have been posting several latest and advanced PIC microcontroller based projects and here is another wonderful wireless home automation project for Engineering/ Diploma students, Android Bluetooth Home Appliances Control System. Android phones are very popular today due to their limitless possibilities, have you thought about..... Listed under: [Bluetooth Projects](#), [Home Automation Projects](#)
285.  [Keyboard Gloves](#) Introduction We created gloves that allow users to type on any hard surface as if they were using a QWERTY keyboard. The gloves recognize the standard QWERTY keyboard layout by recognizing which finger is pressed, and how bent the finger is. It is limited to..... Listed under: [Other Projects](#)
286.  [Universal High-Power LED Driver – Firmware update using PIC16F1823](#) Here's the updated firmware for my Universal High-Power LED Driver. This version has on-board current set up function, so you can change the drive current without re-programming the PIC microcontroller. You can either download the ZIP file containing the while project, or just the HEX file. After upgrading..... Listed under: [LED Projects](#), [Projects](#)
287.  [Digital Voltmeter Using PIC Microcontroller 16F877A and Seven Segments Display \(0-30V\)](#) We are all aware of about voltmeters (voltage meter), which is nothing but a device used to measure voltage between given two terminals. Apart from the basic usage digital voltmeters are also employed as panel meters for automation systems and robotics. There are analog and..... Listed under: [Metering - Instrument Projects](#)
288.  [Digital Clock using PIC Microcontroller and DS1307 RTC](#) A Digital Clock can be made easily by using PIC Microcontroller, DS1307 and a 16x2 LCD. I have already posted about Interfacing DS1307 RTC with PIC Microcontroller. The DS1307 RTC can work either in 24-hour mode or 12-hour mode with AM/PM indicator. It automatically adjusts..... Listed under: [Clock and Timer Projects](#)
289.  [PIC and EEPROM Programmer](#) Project Summary In this project we are building a JDM programmer that can handle PIC12, PIC16 and PIC18 family microcontrollers and some popular 24C family EEPROMs. The programmer also provides ICSP feature that allows In-Circuit Serial Programming. So if you desire, you will not have..... Listed under: [Memory - Storage Projects](#), [Microcontroller Programmer Projects](#), [Projects](#)
290.  [GPS Navigator for Runners](#) The basic idea of this 4760 final project is to build a GPS navigator for runners who are new to their neighborhood. For example, if someone is new to Cornell University, College of Engineering, and wants to run around the engineering quad every day, this..... Listed under: [GPS Based Projects](#)
291.  [PIC 16F877 / 16F874 Development Board](#) The Development Board v. 1.1 connected to an LCD display. It is well visible (read further, in the description) the row of LEDs used to check the logic state of up to 8 I/O ports or external circuits' pins. Of course, if you own an..... Listed under: [Development Board - Kits Projects](#), [Projects](#)
292.  [Interfacing EM-18 RFID Module with PIC Microcontroller](#) EM-18 RFID Reader Module is the one the most commonly used module for Radio Frequency Identification Projects. It features Low Cost, Small Size, Low Power Consumption and Easy to use. It can be directly interfaced with microcontrollers using UART communication. Software UART can be used..... Listed under: [Interfacing\(USB - RS232 - I2c -ISP\) Projects](#)
293.  [The Super-Simple pocket size mp3 player using PIC16LF877A](#) It is based on the PIC 16LF877, with plenty of processor time to spare. There is a bare bones assembly version, and a new C version with more features and stability. It uses compact flash cards up to over 100 gigabytes (once they exist) including..... Listed under: [Projects](#), [Sound - Audio Projects](#)
294. [Introducing the Science of Microchip PIC14](#) Engineers of my generation in the UK will remember the Science of Cambridge Mk14. Intended to be Sir Clive Sinclair's first home computer kit for the general public, it served to train a generation of electronics engineers in how to program microprocessors. The Mk14 was..... Listed under: [Other Projects](#), [Projects](#)

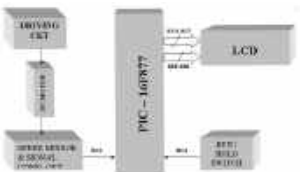



295.  [Automatic Signal Transformer and Custom Filter Designer](#) This laboratory aims to implement a custom filter designer on the PIC32 microcontroller for the purpose of real time signal transformation. The project gets its premise out of the frequent requirement for arbitrary digital signal filters in a laboratory setting. For a video of our..... Listed under: [Wireless Projects](#)
296.  [How to Implement SPI Using PIC18F4550](#) The Serial Peripheral Interface (SPI) is a high speed, synchronous, serial communication standard. This communication protocol is basically a Master – Slave implementation where the master device controls the clock based on which the slave devices operate. The master communicates with a slave or a..... Listed under: [How To - DIY - Projects](#)
297.  [LCD Module Control over IR Link using PIC16F690](#) Recently I got my hands on a couple of HSDL-1100 based IR transceivers and a KS070B LCD display module. This was a nice opportunity to experiment with three things: (1) controlling an LCD module, (2) serial communication between two PIC microcontrollers, and (3) making this..... Listed under: [LCD Projects](#), [Projects](#)
298.  [How To Use PIC Microcontroller For Voice Input And Output](#) Microcontrollers are purely digital devices which work on logic0 and logic1 voltages; still they are widely used for analog signal processing. There are specialized signal processors chips available which are custom made for particular applications; however a general purpose microcontroller is more than enough for..... Listed under: [PWM Projects](#)
299.  [EMG Signal Controlled Game](#) The idea of this project is to design and implement two channels EMG signal controlled video game. The player controls the motion of the ball to the left or to the right to avoid the descending obstacles. Electrods will be placed to the back of..... Listed under: [Game - Entertainment Projects](#)
300.  [Alarm Clock Retrofit using PIC16F877](#) I had some beef with my (very) old alarm clock. It had a radio which was nice to wake up to, but two problems: 1) I would be in bed and think "Wait, did I set the alarm?" I would have to get up, turn..... Listed under: [Clock and Timer Projects](#)
301.  [Generating PWM with PIC Microcontroller – MPLAB XC8](#) Pulse Width Modulation (PWM) is the one of the simple and most commonly used technique to produce analog voltages from digital signals. It has a wide variety of applications such as Digital to Analog Converter (DAC), DC Motor Speed Control, Sine Wave Inverters, Brightness control..... Listed under: [PWM Projects](#)
302.  [Digital Thermometer and Clock Project \(Version 1.0\)](#) This device uses two digital sensors (DS1620 or DS1820), measures the ambient temperature with 0,1 °C (0,2 °F) resolution and displays it on LCD 2x16 (LM016 etc.) screen. It have a clock, which is based on DS1302 timekeeping chip. This chip stores current date and..... Listed under: [Clock and Timer Projects](#)
303. [3-D Game on LED Cube with PIC32 Microcontroller](#) Introduction: Bringing games played on 2-dimensional screens into 3-dimensional space. When games are played on flat 2-dimensional screen, it greatly limits the player's interaction with the game. It simply kills some of the exciting aspects and new possibilities within the game that we might be..... Listed under: [Game - Entertainment Projects](#)
304.  [Picaxe LED night light](#) This is a little night-light that comes on when it gets dark, to illuminate dark rooms or hallways. I'm sure you can buy these cheaply ready made but it's more fun to make your own, and this way it can be customised exactly how you..... Listed under: [LED Projects](#)
305.  [Digital DC watt meter project using pic microcontroller](#) Measuring the voltage and current will always be helpful while making or debugging any electrical system. In this project we are going to make our own Digital Ammeter using PIC16F877A Microcontroller and current sensor ACS712-5A. This project can measure both AC and DC current with a..... Listed under: [Metering - Instrument Projects](#)

306.  [Nokia 3315 / 3310 LCD interfacing with Microcontroller](#) Displaying content on a normal alphanumeric display is very limited, we have to be limited with the font size and we can't draw any graphics also. but convention Graphics lcd are really very expensive so here is the solution, you can use Nokia 3315 / 3310 monochrome LCD to display your..... Listed under: [LCD Projects](#), [Phone Projects](#)
- 
307.  [Cell Phone Detector](#) Project Summary This is a mobile phone sniffer circuit that can detect the signals being used in the GSM (Global System for Mobile Communication) band at about 900 MHz. Since the signals are digitally encoded, it can detect only the signal activity, not the speech..... Listed under: [Phone Projects](#)
- 
308.  [Robotic Candy Sorter](#) Introduction Many embedded systems leverage a hierarchical structure in their product architecture for a more robust and efficient product. The more complex the product becomes, it is more preferable to segment tasks according to the processing unit's role to observe optimal tradeoffs in the system..... Listed under: [Robotics - Automation Projects](#)
- 
309.  [PIC 16f877 microcontroller based RPM Meter](#) Summary: The speed of the motor is measured in Rotations per Minutes, RPM. The RPM Meter is to read the running speed of Motor like DC MOTOR. Here the speed of the DC Motor is sensed with the help of a speed sensor and it is signal..... Listed under: [Metering - Instrument Projects](#)
- 
310.  [PC Based Digital Voltmeter Using PIC 16F877A](#) This is a simple voltmeter which measures 0-5V at a precision of 4.8 mV. This is a simple design using inbuilt ADC of PIC 16F877A. PIC 16F877A have 8 channel 10bit ADC. This is a computer interfaced project. Measured voltage is output in serial interface..... Listed under: [Metering - Instrument Projects](#)
- 
311.  [Sending SMS Text Message using PIC Microcontroller – Flowcode](#) Figure 1: Controlling and Monitoring devices with a Cellphone A GSM modem is a wireless modem that works with a GSM wireless network. GSM stands for Global System for Mobile communications, this architecture is used for mobile communication in most of the countries in the..... Listed under: [GPS Based Projects](#)
- 
312.  [PIC Controlled Relay Driver using PIC16F84A](#) Project Summary This circuit is a relay driver that is based on a PIC16F84A microcontroller. The board includes four relays so this lets us to control four distinct electrical devices. The controlled device may be a heater, a lamp, a computer or a motor. To..... Listed under: [Development Board - Kits Projects](#), [Home Automation Projects](#), [Projects](#)
- 
313.  [ParkBot: The Autonomous Parallel Parking Car](#) Abstract Parallel parking is often the most difficult part of ordinary drivers, and one of the most feared tasks for some. Big cities specifically require great amount of parking skills as parking spaces are often limited. Removing the difficulty, stress and uncertainty of this task..... Listed under: [Car Projects](#)
- 
314.  [Design and Development of an Automated Home Control System Using Mobile Phone](#) Abstract This paper presents design and development of an Automated Home Control System (AHCS) using mobile phone. A cell (mobile) phone acts as a modem for the control of electrical home appliances. This is achieved when the mobile phone number is dialed and an appropriate..... Listed under: [Home Automation Projects](#), [Phone Projects](#)
- 
315.  [Single Pic Micro single shot bi stable Relay](#) Project Summary Build yourself a single shot Pic Micro Controlled by stable Relay FEATURES 1. One touch activated for on or off 2. Open connections for other sensors 3. 10 -12 volt operation 4. Led indicators for on off status 5. Can be Rf controlled..... Listed under: [Development Board - Kits Projects](#), [How To - DIY - Projects](#), [Projects](#)
- 
316. [Microcontroller measures heart rate through fingertip](#) Step 1: Sensor assembly The sensor unit consists of an infrared light-emitting-diode (IR LED) and a photo diode, placed side by side, and the fingertip is placed over the sensor assembly, as shown below. The IR LED transmits an infrared light into the fingertip, a..... Listed under: [Medical - Health based Projects](#)







327. [Homemade Scope Clock DG7 tube and PIC16F876](#) Powersupply and CRT deflection and microcontroller test circuit. I was lucky to purchase two used but working DG7 tubes and a transformer cheap, one from Mullard and one from Phillips. Other CRT Cathode Ray Tube types can be used, you can even rip one from..... Listed under: [Clock and Timer Projects](#), [Home Automation Projects](#), [How To - DIY - Projects](#)



328. [HAND-GESTURE CONTROLLED ROBOT](#) High-Level Design The project can be logical separated into two different components: the glove and the car. The glove is the main way the user will interact with the car. Several fingers on the glove are outfitted with flex sensors to capture events when the..... Listed under: [Robotics - Automation Projects](#)

329. [100KHz Square Wave generator using PIC16C84](#) Following on from the LED flasher circuit, we can reduce the delay in the loop to 10uS (10 microseconds) and produce a 100Khz square wave. Given a 4 Mhz PIC 16C84, the program below will generate a 100Khz square wave on PORTA bit 0 (i.e..... Listed under: [Other Projects](#), [Projects](#)

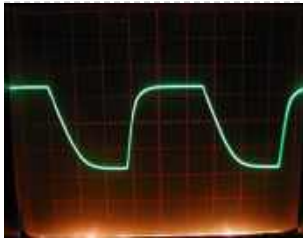

330. [Electronic door code lock with PIC](#) description This is my electronic code lock to use with an outdoor gate. The lock itself is implemented in software. It operates a relay (for example to open a door) for a few seconds if someone enters the valid code. The secret code can be changed..... Listed under: [Interfacing\(USB - RS232 - I2c -ISP\) Projects](#)

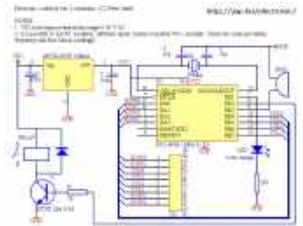

331. [Dual programmable keypad code lock using PIC18F452](#) Open electrical doors with your secret code only! Here are the technical specifications: Up to two keypads may be connected to drive both relay outputs. Professional, outdoor or other keypads may be used. Relay outputs are configurable: output voltage +6 to +24VDC (from power input)..... Listed under: [Projects](#), [Security - Safety Projects](#)



332. [Whistle Controlled Light Switch](#) Introduction For our final project, we built a whistle controlled light switch. We were motivated by the daily struggle of getting out of bed to turn on/off the light. You can attach our final product on any light switch that can be commonly found in..... Listed under: [Other Projects](#)



333. [Understanding ICSP for PIC Microcontrollers](#) Programming microcontrollers isn't hard. Building a programmer makes a great first electronics project. The goal of this instructable is to explain the simple 'in circuit serial programming' method used with Microchip PICs. Step 1: Why ICSP? Programming a big DIP (through hole) chip is easy..... Listed under: [Interfacing\(USB - RS232 - I2c -ISP\) Projects](#)

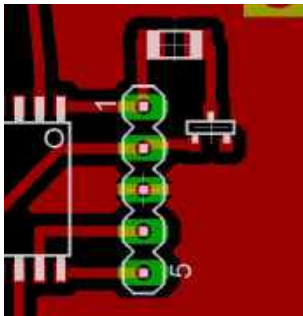

334. [Touch Switch using PIC12F629 Microcontroller](#) You can add this circuit to all sorts of projects that require on-off control. Our design allows up to 4 touch sensors using a PIC12F629. The output of each touch sensor is active LOW and this can be connected to an additional circuit to control..... Listed under: [How To - DIY - Projects](#), [Projects](#)



335. [SOLAR TRACKER-1 using PIC12F629 Microcontroller](#) This project will improve the output of your solar panel by about 40%. It uses a motor and gearbox from a 3.6v power screwdriver, however a number of different voltage motors can be used. The project has its own 6v power-supply made from five 1.2v..... Listed under: [Home Automation Projects](#), [Motor Projects](#), [Projects](#)















336. [SKY WRITER using PIC12F629 Microcontroller](#) We have seen many projects using a set of LEDs to produce words "in the air," but none have the clever feature we have included. Most of the projects are "shaken in the air" and produce messages that are "all over the place." But if..... Listed under: [LED Projects](#), [Projects](#)



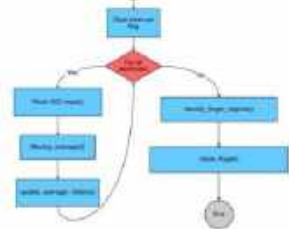

337.  [Electronic Tuner Design](#) This project aims to implement an electronic tuner which is able to analyze sound samples and display the notes contained in the sound. It utilizes a PIC32 microcontroller, a microphone circuit, and a TFT LCD to achieve that purpose. The intuition of making this project..... Listed under: [Other Projects](#)
- 
338.  [MUSIC BOX using PIC12F629 Microcontroller](#) This project is an extension of a number of musical projects (Happy Birthday and It's a Small World) and puts 11 melodies into a single design. It's called EVOLUTION. From the previous projects we learnt a lot about producing a tune. The first thing we..... Listed under: [Game - Entertainment Projects](#), [Projects](#)
- 
339.  [Lift Counter using PIC12F629 Microcontroller](#) This project has been developed due to a request from Mr Moshweunyane (dmoshweunyane8@gmail.com). He asked for a circuit that would count up when someone entered a lift and count down when someone exited, using two infra-red sensors. All we had to do was take the..... Listed under: [Clock and Timer Projects](#)
- 
340.  [Audio spectrum analyzer using PIC18F4550](#) Introduction This project implements a real-time audio spectrum analyser using a PIC18F4550 8-bit microcontroller. The spectrum frequency analysis is performed by a highly optimised 16-bit Fast Fourier Transformation (FFT) routine coded entirely in C. The output from the FFT is displayed using a 128x64 graphical..... Listed under: [Projects](#), [Sound - Audio Projects](#)
- 
341.  [Seven Segment Multiplexing using PIC18F4550 Microcontroller](#) As explained earlier, a seven segment interfaced with PIC uses almost an entire port (minimum 7 pins) to display a value. But a real time application, like watch, calculator etc., usually requires at least 3-4 seven segments. In such a case it is not advisable..... Listed under: [Clock and Timer Projects](#), [Projects](#)
- 
342.  [LAWL-E: The Platform Stabilizer](#) Introduction The purpose of this final project is to implement a microcontroller-based platform stabilizer. The major components of the platform stabilizer is an Inertial Measurement Unit (IMU) and two 180 degree rotation servos. The IMU uses a combination of a 3-axis accelerometer and a 3-axis..... Listed under: [Other Projects](#)
- 
343.  [Precision Delay Timer for PIC16F628A](#) Description This project is a crystal controlled precision timer providing accurate delays from 1 second to 15 hours 45 minutes. The timer delay is set using a 10-way DIP switch. The timer is started by pressing a switch on the main PCB or from an..... Listed under: [Clock and Timer Projects](#)
- 
344.  [Breathe-Easy EEG](#) Introduction By measuring brain activity using electrodes and an amplifier circuit, electroencephalograms (EEGs) are at the intersection of electrical engineering and neuroscience. By using signal processing techniques, we can examine the effects of external stimulation, such as music and meditation, on brain waves. We primarily..... Listed under: [LED Projects](#)
- 
345.  [Automatic Charger Sharing for Motorcycle Battery Charger using PIC16F628A](#) Description This project came about because I have three motorbikes and being a bit of a fair weather biker they don't get used much over the winter months. I have an OptiMate™ 4 charger that I connect to the bikes but this needs me to..... Listed under: [Battery Projects](#), [Car Projects](#), [Projects](#)
- 
346.  [PIC Harmonic Distortion Meter](#) The 3rd harmonic distortion meter has been designed for measuring the quality of AC supply. The meter is built with a PIC18F2550 project board and the full wave rectifier front-end circuit. The AC power line, 220VAC is measured through the step down isolation transformer. The..... Listed under: [Memory - Storage Projects](#)
- 
347.  [PIC32 Gaming Console w/ Rapid-Developing Engine](#) Introduction Our project design is an exquisite PIC32-based gaming console that supports NTSC video output, audio output and takes input from a NES Controller. Also we have fully developed an easy-to-use game engine that PIC hobbyists can rapidly develop any favorite game on the console..... Listed under: [Game - Entertainment Projects](#)
- 
348.  [Breakout board for PIC16F1847 microcontroller](#) This is an improved version of my 18-pin PIC16F series breadboard module that I have used in many of my PIC tutorials and projects published in this website. The new version has got a +5V power supply regulator on-board and a 2.1mm female barrel jack..... Listed under: [Development Board - Kits Projects](#), [Projects](#)
- 
349.  [PicBerry Oscilloscope and Function Generator](#) Introduction We created an affordable Digital Oscilloscope and Function Generator that is able to plot and produce (at the same time) generated electric signals (voltage) changing over time along a calibrated scale. The device provides the basic Digital Oscilloscope functionality of plotting the varying voltage..... Listed under: [Other Projects](#)

350.  [Interface a HD44780 Character LCD with a PIC Microcontroller](#) Introduction An HD44780 Character LCD is a liquid crystal display (LCD) display device designed for interfacing with embedded systems. These screens come in a variety of configurations including 8x1, which is one row of eight characters, 16x2, and 20x4. The most commonly manufactured configuration is..... Listed under: [LCD Projects](#)
351.  [Revised version of the PIC12F microcontrollers breakout board](#) The 12F series of PIC microcontrollers are handy little 8-pin devices designed for small embedded applications that do not require too many I/O resources, and where small size is advantageous. These applications include a wide range of everyday products such as hair dryers, electric toothbrushes,..... Listed under: [chipKIT Projects](#), [Development Board - Kits Projects](#), [Projects](#)
352.  [Serial LCD Module using PIC16F88](#) Many times when I'm working with a small MCU such as 8 pins or 18 pins MCU. I found that I don't have enough MCU pins for parallel LCD display. So it's good to have a one-pin-require LCD module for experiment. Actually, serial LCDs are..... Listed under: [LCD Projects](#), [Projects](#)
353.  [Build your own Wireless Network detector using PIC12F629](#) What This Is This project is for a small electronic unit that allows the user to sense the presence and relative signal strength of wireless hotspots. It can be worn as a pendant or carried in a pocket. It is "always on" and communicates the..... Listed under: [How To - DIY - Projects](#), [Internet - Ethernet - LAN Projects](#), [Projects](#), [Sensor - Transducer - Detector Projects](#)
354.  [Automated Resistor Sorter with GUI](#) Introduction Our project is a resistor sorter that allows users to input multiple resistors, measure their resistance, and sort them into predefined bins or return them to the user. For a video of our sorter, please see our Project Demo. From the onset, we wanted to..... Listed under: [Other Projects](#)
355.  [DIY remote control based on PIC16F628](#) Control up to 8 devices by this easy constructable remote control. It can work as a radio or infrared remote control, depending on the components. Each device output can be configured to be momentary (turned on while you press the button) or latched. Latched outputs..... Listed under: [Home Automation Projects](#), [How To - DIY - Projects](#), [Projects](#)
356.  [Blink a LED with Assembly Language & a PIC](#) To state the blindingly obvious, there are many flavors of microcontroller in the world. There are innumerable applications for them too. This Instructable will cover the steps necessary to blink a LED using a PIC microcontroller and Microchip assembly language, showing you how to access..... Listed under: [LED Projects](#)
357.  [The IR Widget Using pic12f629](#) Simple IR capture for multitasking operating systems The IR Widget captures the infrared signals used by remote controls. It operates in a way that makes it compatible with modern multitasking operating systems. It is able to determine the carrier frequency and demodulate the carrier in..... Listed under: [RTOS - OS Projects](#)
358.  [PIC 16F84 Serial Programmer](#) The Microchip PIC 16C84 was one of the first serial in-system programmable microcontroller. I saw PIC serial programmers published in Electronic magazines in 1993. Today, many PIC programmer circuits - for serial and parallel PC ports - are published on the Internet. Despite its somewhat..... Listed under: [Microcontroller Programmer Projects](#), [Projects](#)
359.  [A DCF77 Clock with RS232 Interface using PIC16F84](#) Description: The clock is synchronised via the German time signal DCF77. It has a display with automatic brightness control and a RS232 computer interface. Design Overview: The clock is built around a PIC16F84 microcontroller from Microchip. I chose this microcontroller since its FLASH memory is..... Listed under: [Clock and Timer Projects](#)
360.  [EMG Robotic Hand](#) Introduction The goal of the project was to create a robotic hand that is controlled by sensing the muscular contractions in the arm of the user and to replicate the movements on the robotic hand. Electrodes will be placed on multiple areas on the arm..... Listed under: [Robotics - Automation Projects](#)
361.  [Ir On-Off using PIC12F629 microcontroller](#) Turn ON or OFF electrical devices using remote control is not a new idea and you can find so many different devices doing that very well. For realization of this type of device, you must make a receiver, a transmitter and understand their way of..... Listed under: [Other Projects](#), [Projects](#)





362.  [1Hz Clock Generator using PIC12F675](#) Based on the idea from [http://www.josepino.com/pic\\_projects/?timebase](http://www.josepino.com/pic_projects/?timebase) have created a 1Hz Clock Generator. I use PIC12F675 as it's available locally. Its price is just about US\$1. The concept is using 32.768kHz crystal as a clock for the PIC. Therefore, the internal instruction clock is  $32768/4 = \dots$ . Listed under: [Clock and Timer Projects](#)
- 
363.  [Pic-Plot2 GPIB to USB converter using PIC16F628](#) Pic-plot now goes to USB! A perfect low cost solution to quickly get screen plots of your GPIB instrument on your laptop PC without complex software. It emulates the HP7470A operation on the GPIB side, and outputs the HP-GL data at the USB port to..... Listed under: [Interfacing\(USB - RS232 - I2c -ISP\) Projects, Projects](#)
- 
364.  [How to build your own PIC-Programmer using PIC12C50x](#) Which types of PIC microcontrollers and EPROM's are supported? You can use this PIC-Burner for PIC12C50x, PIC12F62x, PIC16FFxx, PIC16F62x and EEPROM 24Cxx. This PIC-Programmer was tested with PIC12C508 (A), PIC12C509 (A), PIC12F629, PIC12F675, PIC16F84A, PIC16F627, and PIC16F628. The PIC-programmer is easy to build and compact..... Listed under: [How To - DIY - Projects, Microcontroller Programmer Projects, Projects](#)
- 
365.  [3D MOUSE APP](#) Introduction We design a wireless 3D mouse to control a music player to change songs and stop and play the song. The 3D mouse responds to all-direction movements as it has a built-in accelerometer. The user gives the commands by moving this mouse to the..... Listed under: [Other Projects](#)
- 
366.  [PIC16F628 4 RGB LED PWM Controller](#) I am a big fan of LEDs. Bright, colorful, flashing LEDs. So, given my affinity for LEDs, I decided to work on a controller that me and a few of my friends could use as an art project/passive information display. I have posted videos from..... Listed under: [LED Projects, Projects, PWM Projects](#)
- 
367.  [An Easy to build & multifunctional counter with 7-Segment Led Display using PIC16F628 microcontroller](#) Just one PIC to use it as counter with multiple functions. Here is the pin information: PIN FUNCTIONS: CLEAR/COUNT - GND to clear count, VSS to count. SAVE COUNT - GND start from zero on power up, VSS continue last count. C CATHODE/C ANODE..... Listed under: [Other Projects, Projects](#)
- 
368.  [Read analog values without an ADC using PIC12F675 microcontroller](#) Digital electronics and Analog electronics doesn't mix easily. A Microcontroller can't get analog values unless an Analog-to-Digital converter is used, however, you may find a little complicated the use of an ADC and it need lots of Input/Output ports. Some Microcontrollers, like the small..... Listed under: [Projects, Sensor - Transducer - Detector Projects](#)
- 
369.  [Pic RGB color generator using PIC12F629](#) Description PIC RGB is a circuit that generates random RGB colors using a RGB LED and fades between them. The idea for this circuit came from the candle simulator [1] and another project called TinyRGB [2]. The challenge was to create an algorithm that..... Listed under: [Game - Entertainment Projects, Projects](#)
- 
370.  [LED Cube with SnakeGo](#) Introduction The idea of our final project is to design and implement a PIC32-driven 8x8x8 LED cube with 3-dimensional display. Besides 3D display feature, another major feature of this magical LED cube is that it provides a playing field and users can play 3D snake..... Listed under: [Game - Entertainment Projects](#)
- 
371.  [Power Pic RGB with Infrared remote control using PIC12F675](#) Power Pic RGB with Infrared remote control is a circuit that generates colors using a RGB LED and can be controlled using any infrared remote controller capable compatible with the Sony® Sirc code. This circuit is the third evolution of Pic RGB project [1] in which..... Listed under: [Internet - Ethernet - LAN Projects, Projects](#)
- 
372.  [Cooking Timer using PIC16F819 microcontroller](#) Cooking Timer This is a school project but I thought it can be fun to all of you cooking people out there, that still use old stoves without timers. The timer uses different formula for meat, chicken or egg, but also has a separate timer..... Listed under: [Blog, Home Automation Projects, Projects](#)
- 
373.  [Minty JDM PIC Programmer using PIC18F4550 microcontroller](#) Minty JDM PIC Programmer This project details how to build a JDM style programmer to program PIC Microcontrollers using Microchip's ICSP (In Circuit Serial Programming) and freeware software (PICPgm). Total project cost: less than \$10. This device has been tested on both the PIC16F877 and..... Listed under: [Microcontroller Programmer Projects, Projects](#)

374.  [Smart-O-Pan ECE4760](#) A smart control knob and pan designed for the absent-minded chef! The Smart-O-Pan takes the constant vigilance out of your culinary creations, making cooking bdddoth simple and safe. [caption id="attachment\_34026" align="aligncenter" width="300"] Figure 0. Handle, Pan, and Hotplate Together[/caption] I designed the smart-o-pan with people..... Listed under: [Other Projects](#)
375.  [An LED Dice using a PIC 16F84 \(or 16F88\)](#) An LED Dice using a PIC 16F84 (or 16F88) This is a re-print of a project that I made a number of years ago - I was trawling the web, and discovered that others had been making it, so I decided to put the detail..... Listed under: [LED Projects](#), [Projects](#)
376.  [Reverse Engineering to Emulate Ink Cartridges for a Epson Printer using PIC18F](#) Reverse Engineering to Emulate Ink Cartridges for a Epson Printer For the past two years, I've been planning to build myself a 3D printer from some old Inkjet printers that I had collected over the years. But not until two weeks ago had I actually..... Listed under: [Other Projects](#), [Projects](#)
377.  [Analog to Digital Converter Using PIC16f877A Microcontroller – Beginners Guide using pic microcontoller](#) What is meant by Analog to Digital Converter (ADC)? An ADC converts analog signal to it's corresponding digital signal. How to convert analog signal to digital signal? CircuitsGallery.com has already posted ADC using LM324 IC, in that ADC tutorial I had already explained Analog to Digital..... Listed under: [Sensor - Transducer - Detector Projects](#)
378.  [IoT Hand Gesture Video Control](#) Introduction In this project, we designed and implemented a system that will utilize light & shadow and relative distance to to recognize the single hand gesture in the air and use different gestures as commands like volume up or speed up to control a video..... Listed under: [Game - Entertainment Projects](#)
379.  [JDM2 based PIC Programmer](#) JDM2 based PIC Programmer Schematic & layout for an updated JDM2 PIC Programmer. Includes clock & data filter, Vpp voltage divider for modern PIC microcontrollers (eg USB PIC 18F2455/4455). Prior to reading sites like www.hackaday.com & www.makezine.com/blog I had worked only with the Amtel/AVR line..... Listed under: [Microcontroller Programmer Projects](#), [Projects](#)
380.  [Traffic Light Controller using pic microcontoller](#) 1.a History: The first single-chip microprocessor was the 4-bit Intel 4004 released in 1971. With the Intel 8008 and more capable microprocessors available over the next several years. These however all required external chip(s) to implement a working system, raising total system cost, and making..... Listed under: [LED Projects](#)
381.  [Wooden LED clock using PIC16LF876A microcontroller](#) Wooden LED clock I really like concept. So many different types of wooden clock have been already built. I've seen many of them but I still don't have my own. What a shame. I'm going to fix it right now. Project is very simple and..... Listed under: [LED Projects](#), [Projects](#)
382.  [Automated Ice Cream Topper](#) Introduction Controlled by a PIC 32, the automated ice cream topper stores individual ice cream topping preferences, outputting the user's ideal solid, liquid, and whip cream topping amount with the push of a button. Our project demo can be viewed here: Project Demo. The automatic ice..... Listed under: [Other Projects](#)
383.  [Bluetooth Wireless Voltage Meter using PIC12F683 microcontroller](#) Bluetooth Wireless Voltage Meter using Wiimote + Pic Chip + Autolt In this tutorial I'm going to be showing you how you can send voltage values to your pc using a Pic chip, Wiimote, and Autoit3 scripting language. The process works by wiring a pic..... Listed under: [Metering - Instrument Projects](#), [Projects](#)
384.  [Audio spectrum analyzer on PIC32 using pic microcontoller](#) This simple audio spectrum analyzer is based on PIC32 proto board on PIC32MX360F512L with 320x240px colour LCD (LVC75Z779 Eval Board). The analyzer can be connected to unamplified audio source like PC's sound card, MP3 player and so on. SSD1928 Module Schematic diagram The reference voltage..... Listed under: [Sound - Audio Projects](#)
385. [What is PIC Microcontroller](#) coming up soon..... Listed under: [Compilers](#), [News & Updates](#), [Programmers](#), [Projects](#), [Tutorials](#)
386. [Usbpicprog – A free and open source USB Microchip PIC programmer \(Software and Hardware\) for Linux, Windows e MAC](#) Usbpicprog is an USB in circuit programmer for Microchip PIC processors family PIC10F, PIC12F, PIC16F, PIC18F, PIC24F, PIC32F and I2C Eeprom 24xx. The hardware is as simple as possible, the current version only contains one PIC18F2550, 4 mosfets, and besides the connectors a hand full..... Listed under: [Interfacing\(USB - RS232 - I2c -ISP\) Projects](#)







387.  [Computer-Controlled Light-Up Water Fountain](#) System Overview La Fontaine Du Campus Est (The Fountain of East Campus) is a computer-controlled, servo-actuated, LED and halogen-lit, sump-pump powered water fountain. It features five streams of water that can each be individually controlled (on/off) as well as pivoted (90 degrees of freedom). Each..... Listed under: [Robotics - Automation Projects](#)

388.  [OPEN-DESIGN CHARGE REGULATOR PROJECT](#) We have been wanting to design and build an open-design, relatively inexpensive but fully functioned charge regulator for solar PV, wind, pedal and small hydro systems for a while now. The majority of off-grid renewable energy systems are based upon lead acid batteries. Lead-acid batteries..... Listed under: [power - energy\\_projects](#)

389.  [Spectrum analyzer based PIC18F4550](#) The project demonstrates the implementation of the sound spectrum analyzer for 8-bit microcontroller PIC18F4550 manufactured by Microchip . Spectrum analysis is performed using an optimized fast Fourier transform algorithm (Fast Fourier Transformation, FFT), written entirely in C language. Data Visualization (spectrum) is carried out in..... Listed under: [LCD Projects](#)

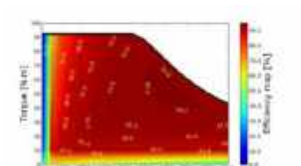
390.  [The Wooden Menace – a Mighty Robotic Arm Powered by Servos using pic microcontoller](#) Introduction When I first started in the field of robotics, electronics and sensors I had always wanted to make my own robotic arm. The idea of being able to make such an advanced idea come to life out of simple parts found around the house..... Listed under: [Robotics - Automation Projects](#)

391.  [ECE 4760 Final Project: Motor Dynamometer](#) Introduction For our final project we built a dynamometer that measures various performance characteristics of small electric motors, such as torque, rpm and efficiency. The final goal was to be able to produce a motor efficiency map like this one, but for this class project..... Listed under: [Motor Projects](#)

392.  [Induction Heater with CKM005 Microcontroller](#) UPDATE 11/7/12 – More pics of device and full disassembly uploaded by Ad. Thanks!. A user nicknamed "Ad" has taken some pictures of the inside of a new induction cooktop by Better China, see their original comments at this article. This device is interesting because..... Listed under: [Metering - Instrument Projects](#)

393.  [Haptic Feedback Weathervane](#) Introduction When sailing a boat, one of the most important factors is the direction of the wind. If they want to keep a steady heading, sailors need to be able to dynamically adjust the direction they steer as the wind changes. Unfortunately, the ability to..... Listed under: [Other Projects](#)

394.  [2.4GHz WiFi & ISM Band Scanner. Part 1 – Description and Schematic using pic microcontoller](#) Have you ever wondered exactly what is going on in the 2.4GHz WiFi and ISM band around your house. What channel is it best to set your wireless router to? Why are you getting such poor performance across your WiFi network? Is your neighbour on..... Listed under: [Wifi - WLAN Projects](#)

395.  [Disco Lights Project using pic microcontoller](#) What does it do? The Disco Lights project is what you get when you combine the fantastic beat detection circuitry of my ever popular beat triggered strobe light with coloured halogen lamps! In other words, four coloured lights flash in a variety of patterns in..... Listed under: [LED Projects](#)

396.  [Borkbit: A Wifi-Enabled Smart Collar](#) Introduction "A smart, wearable device for your pet." Borkbit is a smart, wearable device for pets that helps owners track their pets from afar. As any pet owner can attest, being away from one's animal friend is difficult. Today, an increasing number of people are..... Listed under: [Wifi - WLAN Projects](#)

397. [How to Interface GSM Module SIM300 with PIC 16F628A Microcontroller for sending SMS and making Calls using pic microcontroller](#) We have seen many Electronics Engineering projects use GSM Modem. GSM modems are widely integrated with GSM security system, GSM alarm to provide easy user interaction of user to the embedded project. What is a GSM module? A GSM module lets you to make calls,..... Listed under: [Interfacing\(USB - RS232 - I2c -ISP\) Projects](#)



398. [How to drive a Dot Matrix LED Display. using pic microcontroller](#) Driving a 64 LED dot matrix LED display is quite simple and just requires ONE TRICK! Here you can find out how to drive an led dot matrix with 64 LEDs (8 rows by 8 columns - 8x8 display) or less e.g. 35 LEDs (7 rows by 5..... Listed under: [How To - DIY - Projects](#), [LED Projects](#)

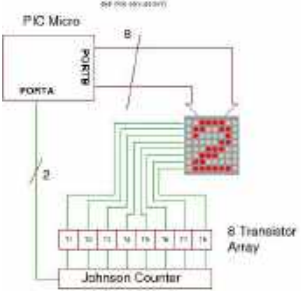

399. [An Inexpensive Microcontroller Based Data Logging System](#) INTRODUCTION Attempts to understand and analyze environmental variables need data sets that track both temporal and geographical changes. These data can be collected using networks of recording instruments or instruments connected to commercially available data loggers (e.g., Silliman and Booth, 1993), but the cost of..... Listed under: [Interfacing\(USB - RS232 - I2c -ISP\) Projects](#), [Microcontroller Programmer Projects](#)

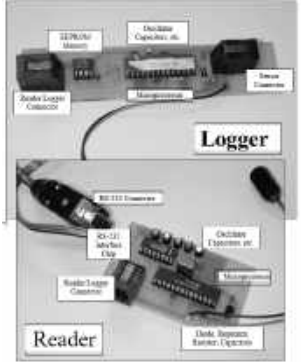

400. [1Hz – 2MHz Function Generator with XR2206 using pic microcontroller](#) 1Hz - 2MHz Function Generator with XR2206 Component List: XR2206 - Function Generator IC Function Generator PCB RCA Gold Plated Connector SW1 - 4-DIP Switch SW2 – (Sine / Triangle) / Square Switch SW2 – Sine / Triangle Switch 1x 3-PIN Gold Plated Male Header..... Listed under: [Radio Projects](#)



401. [EOG-Controlled Video Game](#) Introduction The goal of this project is to develop an electrooculography (EOG) system that can record potentials across a user's eyes, and use the resulting signal to control a simple video game. An electrooculograph is a device that measures the standing potential across the human..... Listed under: [Game - Entertainment Projects](#)

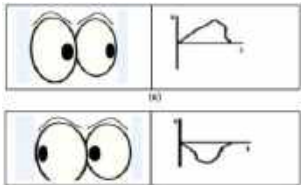

402. [USB 0-500MHz RF Power Meter with AD8307 using pic microcontroller](#) AD8307 USB 0-500MHz RF Power Meter Component List: 1x PIC18F2550 Programmed Microcontroller 1x AD8307 RF Power Meter IC 1x RF Power Meter Probe PCB 1x USB IO Board PCB 1x USB Type B Connector 1x 20MHz Crystal Resonator 1x 470K Resistor (yellow purple yellow gold)..... Listed under: [Interfacing\(USB - RS232 - I2c -ISP\) Projects](#), [Metering - Instrument Projects](#)

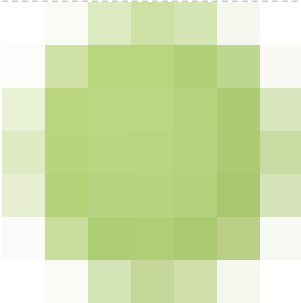

403. [USB IO Board PIC18F2455 / PIC18F2550 using pic microcontroller](#) USB IO Board Component List: 1x PIC18F2455 / PIC18F2550 Programmed Microcontroller (MCU) 1x USB Type B Connector 1x 20MHz Crystal Resonator 2x 10K Resistor (brown black orange gold) 1x 470 Resistor (yellow purple brown gold) 1x 470nF Ceramic Capacitor 1x 100nF Ceramic Capacitor Technical Specifications:..... Listed under: [Interfacing\(USB - RS232 - I2c -ISP\) Projects](#)

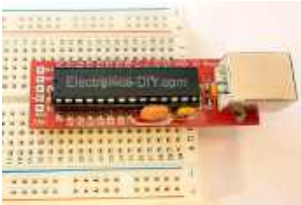

404. [ESR Meter using pic microcontroller](#) The ESR meter is perfect for any electronics repair technicians, engineers or hobbyist. This handy meter measures electrolytic capacitor equivalent series resistance (ESR) in the circuit. ESR is a very important characteristic of capacitors greater than 1 microfarad. This meter makes measurements which are often..... Listed under: [Metering - Instrument Projects](#)



405. [BA1404 HI-FI Stereo FM Transmitter 88 – 108 MHz usnig pic microcontroller](#) BA1404 Stereo FM Transmitter Components: BA1404 IC 38KHz Crystal L1 - 3.5 Turns Variable Coil 1x PCB 1x 38KHz Crystal Oscillator 1x DIP-18 IC Socket 1x 3.5T Variable Precision RF Coil 1x 10uH Inductor 4x 10uF/50V Gold Audio Capacitors 4x 1nF Ceramic Capacitors 2x 1nF..... Listed under: [Radio Projects](#), [Wireless Projects](#)



406. [SLEEP QUALITY METER](#) INTRODUCTION Sound Bite A sleep quality meter that uses heartrate, breathing rate, and movement metrics to judge the quality of the user's sleep. The What and the Why We created a system that monitors the quality of the sleep of its user. As..... Listed under: [Metering - Instrument Projects](#)

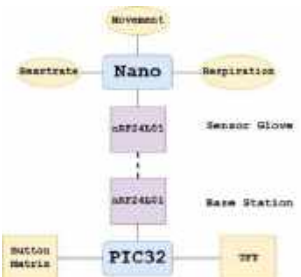

407. [Voltmeter Ammeter using pic microcontroller](#) Voltmeter Ammeter Component List: 1x PIC16F876A - Programmed microcontroller 1x 2x16 LCD with Green or Blue Backlight 1x High quality PCB with red solder mask and plated through holes 1x 4MHz Resonator 1x LM7805 5V Voltage Regulator 1x 16x1 Gold Plated Female Header (PCB) 1x..... Listed under: [Metering - Instrument Projects](#)





408. [60MHz Frequency Meter / Counter using pic microcontroller](#) Component List: 1x 16x2 LCD Display with Green/Blue Backlight 1x PIC16F628A Pre-programmed MCU 1x PCB 1x 18-DIP IC Socket 1x 4.000MHz Crystal 1x LM7805 5V Voltage Regulator 1x 1x16 Gold Plated Female Header (for PCB) 1x 1x16 Gold Plated Male Header (for LCD) 2x 1x2..... Listed under: [Metering - Instrument Projects](#)



409. [Pickit 2 clone The Universal Microchip PIC Programmer /Debugger](#) The PICkit™ 2 Programmer/Debugger is a low-cost development tool with an easy to use interface for programming and debugging Microchip's Flash families of microcontrollers. The full featured Windows programming interface supports baseline, mid-range, PIC18,8-bit, 16-bit, and 32-bit microcontrollers, and many Microchip Serial EEPROM products. With Microchip's powerful MPLAB Integrated..... Listed under: [Microcontroller Programmer Projects](#)



410. [Infrared Camera on the PIC32](#) Introduction The purpose of this project was to create thermal images displayed on the TFT screen of the PIC32 using data inputted through a thermal camera. A thermal image is an image where the colors are representative of the amount of heat radiated by that..... Listed under: [Video - Camera - Imaging Projects](#)



411. [How to burn or program PIC Microcontroller?](#) This DIY PIC programmer is a continuation of our PIC programming basics tutorial. By using this USB PIC programmer, you can program microchip PIC series of 10F, 12F, 16F, 18F, 24F, 30F. This is also an EEPROM programmer as it supports 12Cxx EEPROM. The main..... Listed under: [Interfacing\(USB - RS232 - I2c -ISP\) Projects](#)



412. [Blinking LED using PIC Microcontroller with Hi-Tech C](#) A lot of you may heard about microcontrollers and its applications. Well it is a bit difficult to start learning microcontrollers. And the guides and tutorials also do not start from zero level which makes learning far more difficult than anticipated. I have tried to..... Listed under: [LED Projects](#)

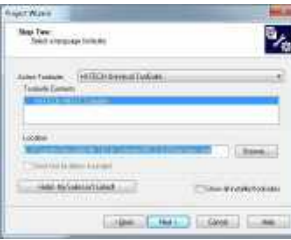

413. [Simple RS232C Level Converter using Transistors using pic microcontroller](#) There're many, who built the Easy Programmer or C-52 EvaluationBoard, asking for the RS232C level converter chip, DS275. Many have changed to MAX232 instead, because of not available in his home. Here is another simple and cheap circuit using small signal transistor providing TTL to RS232C level converter..... Listed under: [Interfacing\(USB - RS232 - I2c -ISP\) Projects](#)

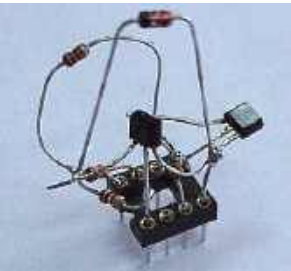

414. [PIC32 Digital Synthesizer](#) Introduction Our final project for ECE 4760: Digital Design Using Microcontrollers is a portable keyboard digital synthesizer using the PIC32MX250F128B microcontroller. The PIC creates various sound effects using direct digital synthesis (DDS) and frequency modulation (FM) synthesis which can be modified using user input on..... Listed under: [Other Projects](#)



415. [The IDE Project](#) 4 prototype boards arrived today. After going over them carefully, I found 4 lines that crossed each other. After some quick surgery with a knife and some solder and wire, the IDE project is now semi portable. The power supply is still out of a..... Listed under: [LCD Projects](#)

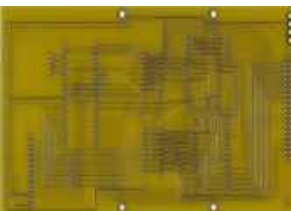

416. [PIC Light Chaser](#) This month I am continuing with the PIC projects that I started in August. To be able to build this circuit you must build the August circuit which allows you the ability to program PIC's. The circuit this month is a simple 8 light chaser..... Listed under: [LED Projects](#)

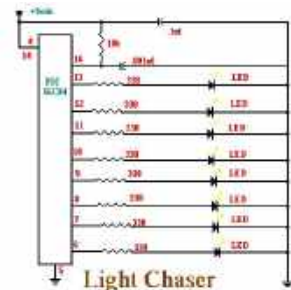

417. [Interfacing DS1307 RTC Chip with AVR Microcontroller](#) Real Time Clocks, as the name suggests are clock modules. They are available as integrated circuits (ICs) and manages timing like a clock. Some RTC ICs also manages date like a calendar. The main advantage is that they have a system of battery backup which..... Listed under: [Interfacing\(USB - RS232 - I2c -ISP\) Projects](#)



418. [CNC Controller Motion Schematics \(Rev. D\) using pic microcontrollers](#) Table of Contents Introduction Power Supply I/O Microcontroller RS422 and Limit Switches X, Y, Z, and Z Axes Solenoid and Motor Control Printed Circuit Board Issues Introduction The parts list is kept in a separate file. Power Supply The power supply schematic is shown below:..... Listed under: [CNC Machines Projects](#)

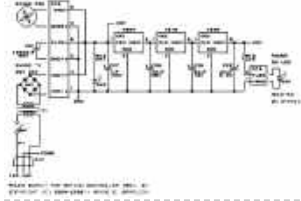

419. [Programmable IR Station](#) Introduction The programmable IR remote controller is an IR remote control platform based on PIC32 that can record and resend the Infrared signal. To help users control programmable IR remote controller, an infrared wave server related to database and website is implemented in this project..... Listed under: [Microcontroller Programmer Projects](#)

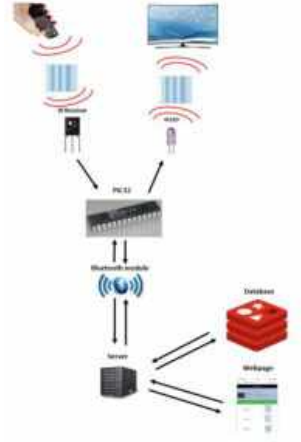

420. [Remote-Control Light Dimmer using pic microcontroller](#) The lamp in my bedroom is a very cheap lamp from Wal-Mart. It stands in one corner of my room, opposite of the door. This is where the problem is: If it is dark, I have to walk across the room, not trip on anything,..... Listed under: [LED Projects](#)



421. [USB data logger project using pic-microcontroller](#) Introduction: In this project, PIC 18F4550 is programmed to perform the function of an oscilloscope. Communication is set up between the computer and the PIC through USB, so that bulk data transfer mode is implemented. Analogue circuits are carefully designed so the user can select..... Listed under: [Interfacing\(USB - RS232 - I2c -ISP\) Projects](#)

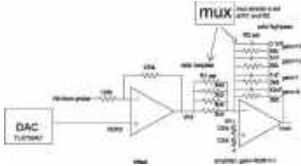

422. [XBee radio communication between PICs using pic-microcontroller](#) Overview Typically, two pics communicate by RS-232, a wired transmission. However, it may be desirable to communicate via a wireless link. This wiki page demonstrates using XBee radio modems which conform to the IEEE 802.15.4 protocol. These radios will allow for wireless communication between two..... Listed under: [Radio Projects](#)



423. [Final Report – VGA Video Game](#) Introduction Do you ever find yourself lamenting that you live in a warehouse of unused VGA monitors, but don't have any VGA signals to feed to them? Do you ever wish that you had a cheap way to drive these displays at high spatial and..... Listed under: [Game - Entertainment Projects](#)

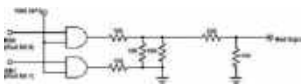

424. [Line Follower Robot – Build it from scratch using pic microcontoller](#) Line Follower Robots are the most common type of robots that are built by hobbyist and student interested in robotics and embedded systems. The reason for the popularity of the Line Follower robot is the fact that is simple to build and easy to understand..... Listed under: [Robotics - Automation Projects](#)



425. [Touch-A-Sketch](#) Introduction For our final project, our team built a touch screen controlled Etch-A-Sketch we call Touch-A-Sketch. The Touch-A-Sketch is the first of its kind that allows users to draw on the touchscreen and sketches the drawing on the Etch-A-Sketch by controlling the knobs on either..... Listed under: [Motor Projects](#)



426. [Interfacing DHT11 humidity and temperature sensor with PIC16F877A using pic microcontoller](#) After interfacing the DHT11 with Arduino uno board at the following post: ARDUINO Humidity & Temperature Measurement Using DHT11 Sensor Now we are going to see how to interface this sensor with microchip pic16f877a. There are some descriptions of how this sensor work in the..... Listed under: [Interfacing\(USB - RS232 - I2c -ISP\) Projects](#), [Sensor - Transducer - Detector Projects](#)





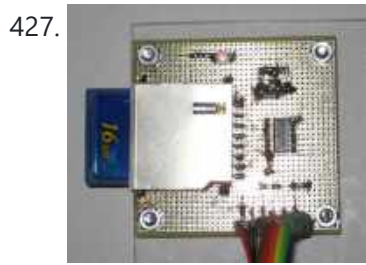

427. [SD-Card with CCS C Compiler using pic microcontroller](#) Description This project shows how to use a SD-Card with FAT16 file system. It is based on the example MMC/SD-Card driver (mmsd.c) and FAT file system driver (fat.c) delivered with the CCS C compiler. Unfortunately, the example didn't work properly for me. So I searched..... Listed under: [Interfacing\(USB - RS232 - I2c -ISP\) Projects](#)

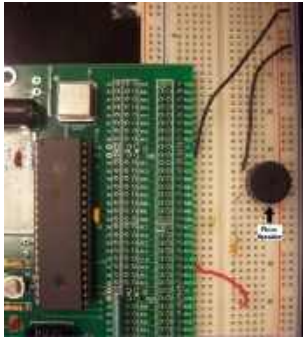

428. [Driving a piezo speaker with a PIC using pic-microcontroller](#), Overview A Pulse Width Modulation (PWM) output from a PIC microcontroller can be used to play tones on a piezo speaker. With this, musical scales and simple songs can be played on the piezo speaker. Piezoelectric speakers operate by the converse piezoelectric effect: when a..... Listed under: [Sound - Audio Projects](#)

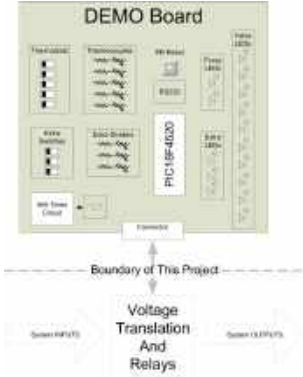

429. [Heat Control System using pic-microcontroller](#) Introduction This project was the first stage of developing a controller for a radiant floor heat system. The microcontroller will use inputs from thermostats, thermocouples, a flow meter, and pressure switches to control the operation of the pumps and valves to achieve improved efficiency of..... Listed under: [Sensor - Transducer - Detector Projects](#)

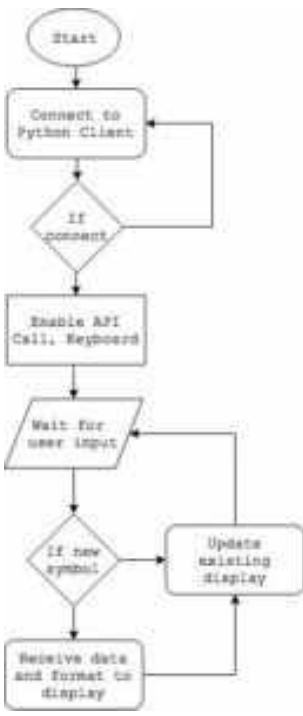

430. [Real Time Stock Monitor](#) Introduction In this project, we demonstrate a real-time stock monitor that uses the popular ESP8266 Wi-Fi module controlled by a PIC32. We decided to build a fun device that fetches chosen stock prices in real-time and displays them on a screen. The goal was driven..... Listed under: [Metering - Instrument Projects](#)

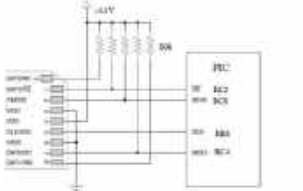

431. [Interfacing with a Secure Digital \(SD\) card using pic-microcontroller](#) Overview Secure Digital Cards, or SD cards, are used to hold information in many common electronic devices from digital cameras to mobile phones and come in sizes as small as 4 MB and as large as 8 GB. In this lab, we will establish communication..... Listed under: [Interfacing\(USB - RS232 - I2c -ISP\) Projects](#)



432. [Switch Relay using pic-microcontroller](#) INTRODUCTION: The Switch Relay was designed to give clients control over two different switch-activated devices using only one switch. Pressing and releasing the switch will directly control the first device. However, when the client presses the switch for a minimum duration of time, the device..... Listed under: [Interfacing\(USB - RS232 - I2c -ISP\) Projects](#)



433. [Pong Bot](#) Rationale The project's focus is to accurately simulate the movement of a human arm on a small-sized robotic arm, such as aiming and throwing small objects, i.e. a ping pong ball. We use motion-controlled, 3-DoF robotic arm that takes the user's throwing motion as a..... Listed under: [Robotics - Automation Projects](#)

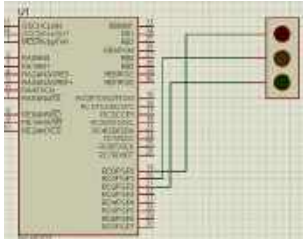

434. [Simple Project on LED blinking by PIC 16 Microcontroller using pic Microcontroller](#) Today I will show you how easily you can build your first project on blinking LED by using PIC 16 microcontroller. In my previous post Step by step Project guide on PIC Microcontroller I was mansion that for start-up we need 1 Proteus 7 Professional (where we Make..... Listed under: [LED Projects](#)

435. [Scrolling Text on LCD by PIC Microcontroller](#) Scrolling Text on LCD by PIC microcontroller is very simple but very important one. For moving forward we need basic knowledge on how to display the text on LCD by pic Micro controller. For that please see my previous post on that "Displaying text on..... Listed under: [LCD Projects](#)



436.

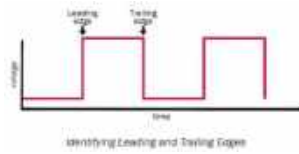

[IoT Security Platform](#) We developed a WiFi enabled doorway security system accessible from anywhere in the world. One of the motivations behind this project was derived from the contemporary notion that the concept of IoT presents security vulnerabilities. We thought that it would be a not only ironic..... Listed under: [Security - Safety Projects](#)

437.



[Lm35 interfacing with pic 16f877 through adc0808](#) Here I discuss on very good project on digital thermometer. I made this project by Lm35 interfacing with pic 16f877 through adc0808. Pic16f877 microcontroller has inbuilt ADC (Analog to Digital Converter but I use external ADC IC (adc0808) because of simplicity of project if I use..... Listed under: [Interfacing\(USB - RS232 - I2c -ISP\) Projects](#)

438.

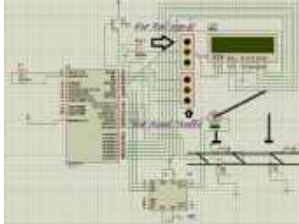

[Automated Railway Gate Controlled by PIC16F877A](#) Here I give you my project on Automated Railway Gate Controlled by PIC16F877A . It is very good project and if it is implemented by railway then they can save lots of money to paying salary for this purpose. For that project I use PIC16F877A,..... Listed under: [Home Automation Projects](#)

439.

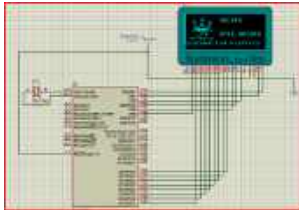

[Interfacing GLCD with PIC16F877A](#) Today I discuss on Interfacing GLCD with PIC16F877A. To overcome the limitation of LCD display we use GLCD (Graphical LCD). By using GLCD now we can display image draw line and shapes page by page which are not possible in normal LCD. So to know..... Listed under: [Interfacing\(USB - RS232 - I2c -ISP\) Projects](#)

440.



[Interfacing Proteus with Matlab](#) It is very important topic that how Interfacing Proteus with Matlab is done? And it is obvious that after interfacing Proteus with matlab lots of way is open for simulating microcontroller based project. We know that in Proteus there has lack of sensor so if we..... Listed under: [Interfacing\(USB - RS232 - I2c -ISP\) Projects](#)

441.

$$\begin{aligned}x &= \rho \sin \phi \cos \theta \\y &= \rho \sin \phi \sin \theta \\z &= \rho \cos \phi\end{aligned}$$

[ECE 4760 Final Project: 3d lidar imaging system](#) Introduction The goal of this final project was to create a lidar 3d imaging system while on a limited budget. This is a system which takes many distance readings while pointing at many different angles. These distance readings are then converted into cartesian points and..... Listed under: [Video - Camera - Imaging Projects](#)

442.

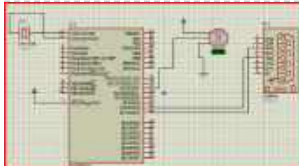

[Servo motor control by Microcontroller PIC16f877 and MATLAB GUI](#) Here you see how a Servo motor controls by Microcontroller PIC16f877 and MATLAB GUI? It is well known to us that now a day's use of servo motor extended in the field of Robotics. Servo motor can rotate with definite angle and we can easily..... Listed under: [Motor Projects](#)

443.



[Interfacing GSM module with PIC Microcontroller](#) In connection with today's advance technology and field of embedded electronics project, interfacing GSM module with pic microcontroller is very important for remote and wireless communication. GSM stands for Global system of mobile communication is widely used chip and reliable mobile network. If we done..... Listed under: [Interfacing\(USB - RS232 - I2c -ISP\) Projects](#)

444.



[Password controlled sliding door with SMS alert by pic Microcontroller](#) In today's world implementation of any expert system with maximum data and networking security becomes a real necessity in home, academic organizations as well as in industrial communities. To provide this security here I give my project on "password controlled sliding door with SMS alert..... Listed under: [Home Automation Projects](#), [Phone Projects](#), [Security - Safety Projects](#)

445.



[Interfacing android with pic microcontroller via Bluetooth](#) To forward our first step in the field of wireless communication by interfacing android with pic microcontroller via Bluetooth open lots of way to work on. Once we can send and receive data between a microcontroller and android mobile then use of android mobile we..... Listed under: [Internet - Ethernet - LAN Projects](#)

446.



[Autonomous Drone](#) Introduction The main goal of my project was to add autonomous flight capabilities to a simple drone framework. I have seen many projects in the past which attempt to develop a flight controller for a drone. While the theory behind this is rather simple, it..... Listed under: [Video - Camera - Imaging Projects](#)

447.

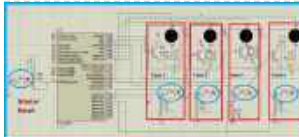

[PIC microcontroller based fastest finger press quiz buzzer project](#) The fastest finger press quiz buzzer is very popular in school, Collage, different T.V. show, different quiz competition. Here in my pic microcontroller based fastest finger press quiz buzzer project you will find four tables with push button. For any instant if four teams on..... Listed under: [Sound - Audio Projects](#)

448.

[Interfacing Relay with PIC Microcontroller](#) To control our high voltage device like home appliance by pic microcontroller, we have to have clear idea on interfacing relay with pic microcontroller. Here I try to answer your very important question with simulation that how to interface relay with pic microcontroller? To discuss..... Listed under: [Interfacing\(USB - RS232 - I2c -ISP\) Projects](#)



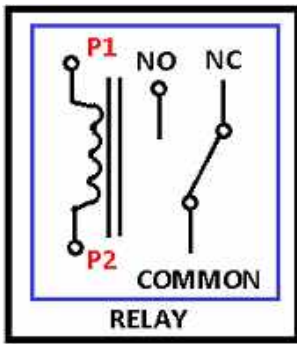

449. [Image Plotter](#) Introduction Our ECE 4760 final project was an image plotting system with high-level processing done in a MATLAB script we wrote and the low-level control software done on the PIC32MX250F128B microprocessor. Our MATLAB program takes images and extracts endpoints of line segments and sends the..... Listed under: [Other Projects](#)

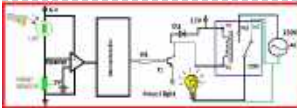

450. [Automatic street light control by pic microcontroller](#) The main purpose of this project "automatic street light control by pic microcontroller" is to minimize the cost of electricity and also cost of man power to manually on- off the street light. In the field of modern embedded world this project "automatic street light..... Listed under: [Home Automation Projects](#)



451. [Interfacing Internal EEPROM with PIC Microcontroller](#) In this project " Interfacing internal EEPROM with PIC Microcontroller ", we will see how we can easily interface EEPROM, send data from microcontroller, store data in EEPROM and read data from EEPROM. In many time we feel that we need to store some data..... Listed under: [Interfacing\(USB - RS232 - I2c -ISP\) Projects](#), [Memory - Storage Projects](#)



452. [Interfacing external EEPROM with PIC Microcontroller](#) In this project "Interfacing external EEPROM with PIC Microcontroller", we will see how we can easily interface EEPROM via I2C Protocol. The need of external EEPROM as a permanent storage of data in any project is enhanced. So now question how to interface external EEPROM..... Listed under: [Interfacing\(USB - RS232 - I2c -ISP\) Projects](#), [Memory - Storage Projects](#)

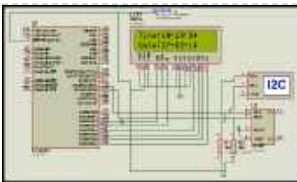

453. [Interfacing DS1307 Real time clock with PIC16f877](#) In any advance project we need real time clock synchronize with our work and for this purpose the best option is DS1307 (RTC Ic). Interfacing DS1307 Real time clock with PIC16f877 is done by I2C communication. To know I2C protocol you may refer my previous..... Listed under: [Interfacing\(USB - RS232 - I2c -ISP\) Projects](#)



454. [Blue Hunters: Bluetooth RSSI Locator Robots](#) Introduction We built 2 small cars which used Bluetooth Received Signal Strength Indicator (RSSI) measurements to navigate towards a stationary base station. The cars and base station used a Bluetooth Low Energy (BLE) 4.0 module to take the measurements and a PIC32MX250 microcontroller. The cars..... Listed under: [Bluetooth Projects](#)

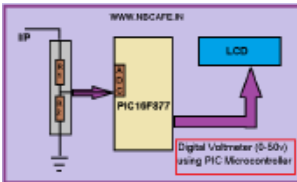

455. [Digital Voltmeter \(0-50v\) using PIC Microcontroller](#) If we know how inbuilt ADC work then we can easily build Digital Voltmeter using PIC Microcontroller. In my previous post, we can see how easily we build "Digital thermometer with auto saving log file in excel by Pic microcontroller". Using the same principle here..... Listed under: [Metering - Instrument Projects](#)

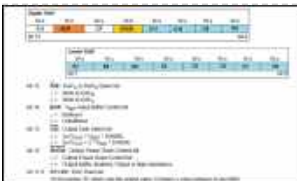

456. [MCP4921 12 bit DAC interfacing with PIC16F877 microcontroller via SPI Connectivity](#) In any real time project, MCP4921 12 bit DAC interfacing with PIC16F877 microcontroller via SPI Connectivity is very essential. Because in real world most of the input sensors and output devices are analog. So if we want to work with those we need to know..... Listed under: [Interfacing\(USB - RS232 - I2c -ISP\) Projects](#)



457. [Interfacing Camera with PIC Microcontroller via Matlab GUI](#) For project on security systems, Interfacing Camera with PIC Microcontroller via Matlab GUI is mostly desirable. But size internal ROM and RAM of PIC16F877 is very small. So it is very difficult or other word imposible to direct Interfacing Camera with PIC16F877 Microcontroller . But we..... Listed under: [Interfacing\(USB - RS232 - I2c -ISP\) Projects](#), [Video - Camera - Imaging Projects](#)

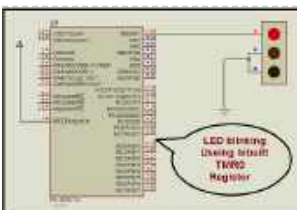

458. [LED blinking using timer0 of pic16f877 microcontroller](#) Here I discuss very good knowledge based project LED blinking using timer0 of pic16f877 microcontroller. You can see in my Earlier project "Simple Project on LED blinking by PIC 16 Microcontroller" where I have used delay program for LED blinking. For LED blinking we have..... Listed under: [LED Projects](#)

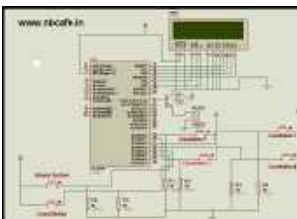

459. [Electronic Voting Machine Using PIC Microcontroller](#) Here you see how easily we can make Electronic Voting Machine Using PIC Microcontroller. By using this machine we can conduct any voting function like audience poll in school, college quiz competition or any small scale general election. Project Description: To make our project "Electronic..... Listed under: [CNC Machines Projects](#)

460. [A recording studio for the PIC32](#) Introduction We built a miniature recording studio using the PIC32 that allows the user to record a short soundtrack, play it back, then layer on additional sounds. We chose to support sounds for three tonal instruments: piano, guitar, and bass, as well as eight unique..... Listed under: [Sound - Audio Projects](#)

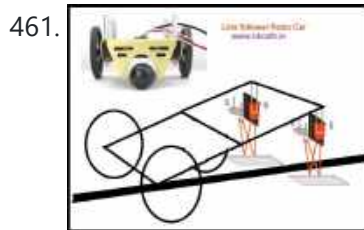
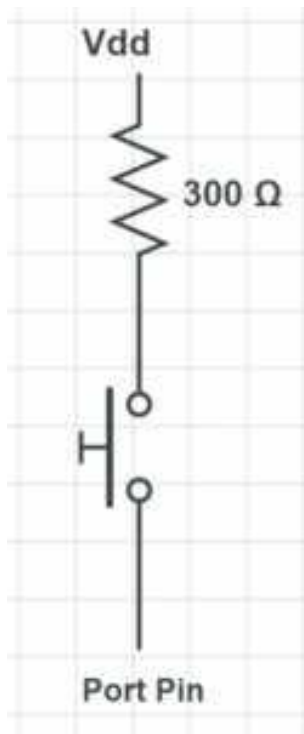

461. [LDR Based Line follower Robot Car using PIC Microcontroller](#) Here I give you description of my project "LDR Based Line follower Robot Car using PIC Microcontroller". This project is very interesting and the concept implementing for making this project is also very interesting. Project description: In this project "LDR Based Line follower Robot Car..... Listed under: [Robotics - Automation Projects](#)

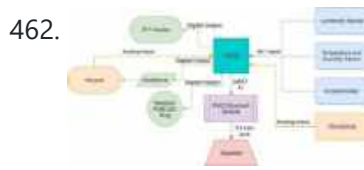

462. [SMART STATION](#) INTRODUCTION Our Smart Station hardware consists of a PIC32MX250 microcontroller with a 3.5mm jack for speakers, a TFT display, keypad, NeoPixel LED ring, microphone, and a host of I2C environmental sensor breakouts: i.e. accelerometer, temperature, humidity, and luminosity sensor breakouts. All of the electronics are..... Listed under: [Sound - Audio Projects](#)

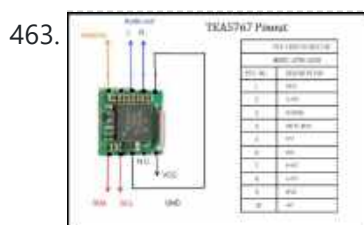

463. [FM radio using TEA5767 and PIC16F877A micro-controller](#) TEA5767 single-chip FM stereo radio. ----- \* High sensitivity due to integrated low-noise RF input amplifier \* FM mixer for conversion to IF of the US/Europe (87.5 MHz to 108 MHz) and Japanese (76 MHz to 91 MHz) FM band \* Preset tuning to receive..... Listed under: [Radio Projects](#)

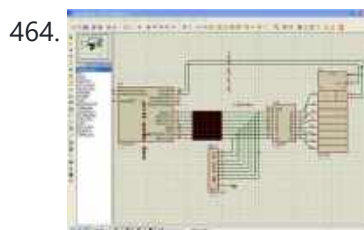

464. [Led matrix project using shift register and pic16f628a micro](#) This is a project to move words on led matrix display we use 1-pic16f628a as microcontroller :cheap,program memory 2k,has internal oscillator,two ports A,B and alot of things. 2-led matrix 8\*8 rows common anode and columns common cathode 3-shift register i use 74ls164 it is simple than..... Listed under: [LED Projects](#)

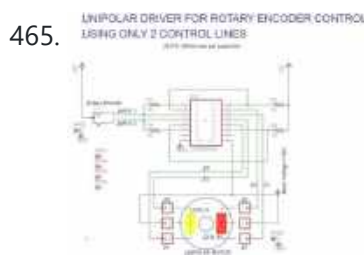

465. [Simple manual control of stepper motors without a PIC or PC](#) This instructable will show you how to control stepper motors (Unipolar OR Bipolar) manually with a knob, without the use of a PIC or PC, so no programming is needed. The position of the knob determines the position of the motor shaft, which will stay..... Listed under: [Motor Projects](#)

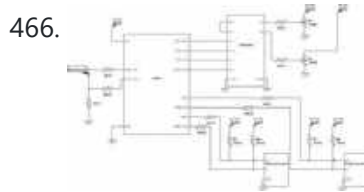

466. [Pic32 Oscilloscope](#) Introduction For this project, we constructed an oscilloscope using the PIC32. The inspiration for this project came from the oscilloscopes we used in lab throughout the semester. These oscilloscopes allowed people to view and understand the behavior of a circuit. Without oscilloscopes, many of the..... Listed under: [Other Projects](#)



467. [Servo Motor Control by using Microcontroller PIC16F877A](#) PIC16F877A is an easy micro controller for the beginners Here in project: 1) How PIC switches servo motor forward and back ward When we push one switch it goes to positive 90 degree , on second switch it moves backward to negative 90 degree a..... Listed under: [Motor Projects](#)

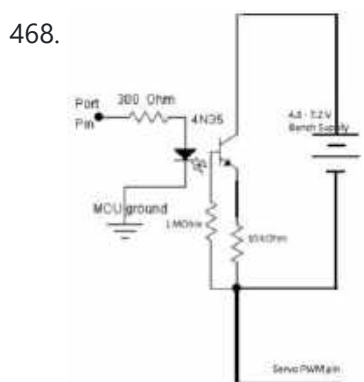









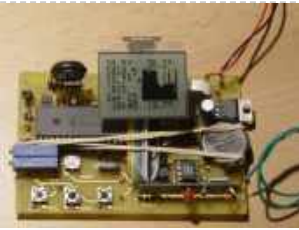

468. [Rubik's Cube Solving Robot](#) Introduction Our project was creating a rubiks cube solving robot that utilized image processing, Kociemba's algorithm, and servos acting as claws/arms to turn the cube. We had a goal of being completely self contained and would not need any human interaction after the initial cube..... Listed under: [Robotics - Automation Projects](#)

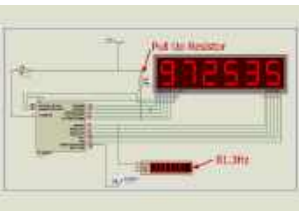



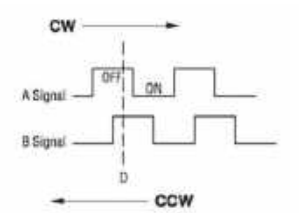



469. [Constellation Glasses](#) INTRODUCTION: The Constellation Glasses allow you to find out what you are looking at in the night sky with the click of a button. On one side of the glasses, there is an accelerometer- magnetometer mounted, which allows us to determine the position of your..... Listed under: [GPS Based Projects](#)

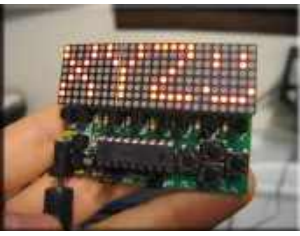

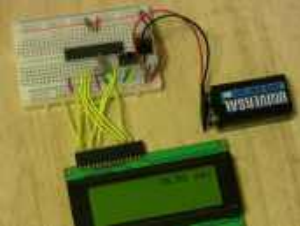

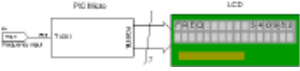
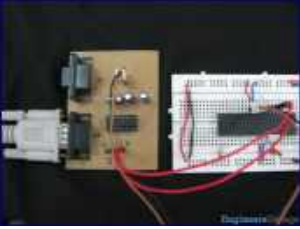
480. [Guitar Hero MMMMDCCLX](#) Introduction: We created our own version of Guitar Hero which can play any song that has a MIDI file by using our custom controller and UI. We are big fans of the original Guitar Hero game, but felt limited by its inability to only play a..... Listed under: [Sound - Audio Projects](#)
481.  [Weather station using PIC18F452 Microcontroller](#) Weather station with pressure reading, relative humidity, indoor & remote outdoor temperature display. Both Celsius or Fahrenheit & mbar/hPa or mm Hg supported. With calendar & clock. Easy 3-button user-menu. 42 hour-history display (curve). Auto-memory & display of all high and low-values. PIC 18F452 running..... Listed under: [CNC Machines Projects](#), [Home Automation Projects](#), [Projects](#)
482.  [PIC based UPS Schematic / Firmware / PCB Layout](#) Microchip's Digital Pure Sine Wave Uninterruptible Power Supply (UPS) Reference Design is based on the dsPIC33F "GS" series of digital-power Digital Signal Controllers (DSCs). This reference design demonstrates how digital-power techniques when applied to UPS applications enable easy modifications through software, the use of smaller..... Listed under: [Battery Projects](#), [Blog](#), [Projects](#), [PWM Projects](#)
483.  [Making a Digital Clock using PIC16F628A](#) Please check the update at === Digital Clock Updated Version === --- Original Version --- As I am a WIS so I built a clock as my first microcontroller project. The clock is controlled by PIC16F628A from the PIC book . The idea was making..... Listed under: [Projects](#)
484.  [A Simple Clock using DS1307 and PIC16F877A](#) Even I have posted about "DS1307 + PIC16F877A", I didn't have chance to make a real prototype of the clock. I have done only on the simulation software. Today, I have received a comment about that post. ah\_bear followed my code and schematic on that..... Listed under: [Projects](#)
485.  [Self-Balancing Robot](#) Introduction The inverted pendulum is an interesting case in the study of control systems because of its unstable nature. A pendulum is considered inverted when its center of mass is placed above its pivot point, meaning that its only equilibrium point is when its center..... Listed under: [Robotics - Automation Projects](#)
486.  [6 Digits LED 7-Segment Multiplexing using PIC16F627A](#) In the post 'LED 7-Segment Multiplexing', I have explained about the concept and benefits of multiplexing. Multiplexing implementation is very similar to driving Led Dot Matrix. I use Timer0 interrupt for switching through each digit. Timer0 or TMR0 is an 8-bit timer which overflows every..... Listed under: [LED Projects](#), [Projects](#)
487.  [Making your own Digital Clock using PIC16F887](#) Small LED dot matrix development board I was very busy for the past two months so this blog just didn't move. As you may know, the LED dot matrix display is my favorite device. I have designed a small development board for testing my led..... Listed under: [How To - DIY - Projects](#), [Projects](#)
488.  [RGB LED Controller using PIC18F452](#) A very popular type of LED that has finally come about is the tri-color, RGB LED. The RGB stands for: red, green and blue since the LED is capable of displaying all three colors, independently. This means that an RGB LED can display any color..... Listed under: [LED Projects](#), [Projects](#)
489.  [PICKit3 Programming With MPLABX](#) The PICKit3 is microchip's newest official PIC programmer and while people argue about how good it is, this programmer has never done me wrong. I upgraded away from the old ICD2 clone programmer that I had used for years when I saw that microchip sells..... Listed under: [Microcontroller Programmer Projects](#), [Projects](#)
490.  [The Sound Designer – A Portable Digital Synthesizer](#) Introduction For this design project, we built a portable digital synthesizer capable of creating a wide variety of sounds designed by the user. The system consisted of a full octave (13 key) keyboard with two-voice polyphony, three rotary encoders for user input, a TFT LCD..... Listed under: [Sound - Audio Projects](#)
491.  [IR Proximity Motor Control using PIC18F4520](#) Infrared proximity sensors are very fun to play with. In the past we have used them to make Digital Theremins and Control Robots, always using its proximity sensing (how far away an object is from the sensor) as the main feature. Today, we're going on..... Listed under: [Motor Projects](#), [Projects](#)
492.  [The Annoy – A Tiny Intelligent Buzzer using PIC10F202](#) A while back I made a blog post about a PIC10F200 Project: The Annoy. In this project they combined the simplicity in design along with the creativeness that I always look for, into a project with no real use other than for fun. However, the..... Listed under: [Projects](#), [Sound - Audio Projects](#)

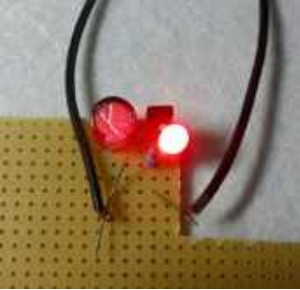

493.  [How to drive an led display matrix using PIC16F88](#) Here you can find out how to drive an led matrix with 64 LEDs (8 rows by 8 columns - 8x8 display) or less e.g. 35 LEDs (7 rows by 5 columns - 5x7 dot matrix). It uses persistence of vision to let you drive the..... Listed under: [How To - DIY - Projects](#), [LED Projects](#), [Projects](#)
- 
494.  [3-DOF Self-stabilizing Quadcopter Frame or: How We Learned To Stop Trying and Not Build the Drone](#) Introduction We created a 3 rotational degree of freedom quadcopter frame. The result was so that when placed on the small surface area of roughly a finger tip, the quadcopter can maintain its stability and recover from perturbations. The four motors increase and decrease in..... Listed under: [Video - Camera - Imaging Projects](#)
- 
495.  [A Real Time Clock using PIC16F88 Microcontroller](#) This PIC project uses an I2C Real Time Clock IC (DS1307) and a four digit seven segment display to create a standard desk clock. Note: If you typed DS1703 Real Time Clock to find this page you probably mis-spelled the chip type. Anyway you can find..... Listed under: [Projects](#)
- 
496.  [50MHz 7 segment frequency counter using PIC16F877A](#) In the same way as the LCD project this frequency counter circuit uses TMR1 in 16 bit counter mode to count the input signal edges. Counter overflows are accumulated to give the total count in multiples of 65536. Adding the current value of the counter..... Listed under: [Metering - Instrument Projects](#), [Projects](#)
- 
497.  [Frequency Counter using PIC16F877A Microcontroller](#) A frequency counter is a useful addition to an engineer's toolbox and you can create the design described on this page for free. All you need is a PIC microcontroller (or any microcontroller that has a high speed timer input module) and a 2 line..... Listed under: [LCD Projects](#), [Metering - Instrument Projects](#), [Projects](#)
- 
498.  [PIC18F452 UART code and Proteus Simulation](#) This post provides the UART code (compiled in MPLAB + HI-TECH C) for PIC18F452 (e-g to connect PIC18F452 controller with PC using serial adapter). Complete project code and the proteus simulation can be downloaded from the Downloads section at the bottom of this post. The following diagram shows the..... Listed under: [Interfacing\(USB - RS232 - I2c -ISP\) Projects](#), [Projects](#)
- 
499.  [Sign Language Learner](#) Introduction We designed a device that can aid in learning the alphabet in American Sign Language. We built a glove with various sensors to identify the hand position of the user closely and use that to give feedback on what they are doing right or..... Listed under: [LCD Projects](#)
- 
500.  [PIC18F452 PWM Code and Proteus Simulation](#) This post provides the PWM code (using C language) and Proteus simulation for PIC18F452 micro-controller CCP1 and CCP2 modules ( written using MPLAB and HI-TECH C18 compiler ). There are many uses for PWM signals, e-g you can control dc motor speed using PWM. CCP..... Listed under: [Projects](#), [PWM Projects](#)
- 
501.  [PIC12F675 LED blinking code and Proteus simulation](#) This post provides the code to make an LED blink using PIC12F675 microcontroller. This code is written in C language using MPLAB with HI-TECH C compiler. This code is intended to be the first step in learning how to use PIC12F675 microcontroller in your projects..... Listed under: [LED Projects](#), [Projects](#)
- 
502.  [Simple Digital Voltmeter \(DVM\) using PIC12F675 \(Code+Proteus simulation\)](#) This post provides a simple digital voltmeter circuit using PIC12F675 microcontroller. This code is written in C language using MPLAB with HI-TECH C compiler. You can download this code from the 'Downloads' section at the bottom of this page. In this post, it is assumed that you..... Listed under: [Metering - Instrument Projects](#), [Projects](#)
- 
503.  [PIC12F675 PWM Code and Proteus Simulation](#) This post provides the PWM code for PIC12F675 microcontroller using timer0. There are many uses for PWM signal, e-g you can control dc motor speed using PWM. Timer0 is initialized in the start of the main function and using timer0 interrupts, PWM is generated. This code is written..... Listed under: [Projects](#), [PWM Projects](#)
- 
504. [Bluetooth Hydration Wearable](#) Introduction We developed a wearable hydration monitoring system that will track an individual's hydration levels by measuring the bioimpedance of the skin, that will transmit the data via Bluetooth to his or her cellphone, and that will provide a visual

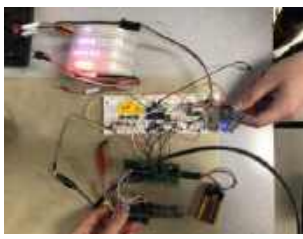

cue corresponding to their hydration..... Listed under: [Bluetooth Projects](#)

505.



[PIC12F675 based digital clock using LCD display \(Code + Proteus simulation\)](#) This post provides a simple digital clock implementation using PIC12F675 microcontroller and an LCD display. This code is written in C language using MPLAB with HI-TECH C compiler. You can download this code from the 'Downloads' section at the bottom of this page. In this article, it..... Listed under: [LCD Projects](#), [Projects](#)

506.



[PIC12F675 based simple calculator \( Code + Proteus simulation \)](#) This post provides a simple calculator project implementation for PIC12F675 microcontroller. This is a simple one digit[1] calculator which implements only 4 functions addition(+), subtraction(-), multiplication(x) and division(/). The code for PIC12F675 is written in C language using MPLAB with HI-TECH C compiler. You can download this..... Listed under: [Calculator Projects](#), [Projects](#)

507.



[How to use PIC12F675 GPIO pin as input \(Code + Proteus simulation\)](#) This post provides an example code to use PIC12F675 GPIO pins as inputs. After going through this example, you will understand how to make PIC12F675 pins as inputs and how to read their value in the code. This code is written in C language using..... Listed under: [Interfacing\(USB - RS232 - I2c -ISP\) Projects](#), [Projects](#)

508.

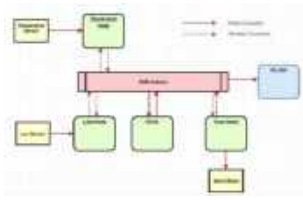

[IOT Home Automation](#) For our ECE4760 final project we built a wireless star network with the PIC32 for remote monitoring and automation. Meant to augment users' abilities to gain insight into their homes through a monitoring station, our system is designed around reliable communication between individual low-cost nodes..... Listed under: [Home Automation Projects](#)

509.



[PIC16F84A LED blinking code and Proteus simulation](#) This post provides the code to make an LED blink using PIC16F84A microcontroller. This code is written in C language using MPLAB with HI-TECH C compiler. This code is intended to be the first step in learning how to use PIC16F84A microcontroller in your projects..... Listed under: [Game - Entertainment Projects](#), [LED Projects](#), [Projects](#)

510.

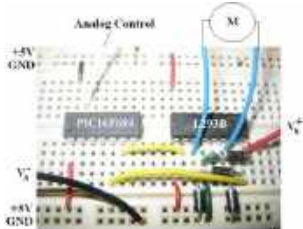

[PIC16F84A PWM code and Proteus simulation](#) This post provides the PWM code for PIC16F84A microcontroller using timer0. There are many uses for PWM signal, e-g you can control dc motor speed using PWM. Timer0 is initialized in the start of the main function and using timer0 interrupts, PWM is generated. This code is written in C..... Listed under: [Projects](#), [PWM Projects](#)

511.



[PIC16F84A LCD interfacing code \(In 8bit mode\) + Proteus simulation](#) This post provides the LCD[1] interfacing code using PIC16F84A microcontroller. This code is written in C language using MPLAB with HI-TECH C compiler. You can download this code from the 'Downloads' section at the bottom of this page. It is assumed that you know how to make an..... Listed under: [Interfacing\(USB - RS232 - I2c -ISP\) Projects](#), [LCD Projects](#), [Projects](#)

512.



[PIC16F84A based digital clock using LCD display \(Code+Proteus simulation\)](#) This post provides a simple digital clock implementation using PIC16F84A microcontroller and an LCD display. This code is written in C language using MPLAB with HI-TECH C compiler. You can download this code from the 'Downloads' section at the bottom of this page. In this article, it..... Listed under: [Clock and Timer Projects](#), [LCD Projects](#)

513.

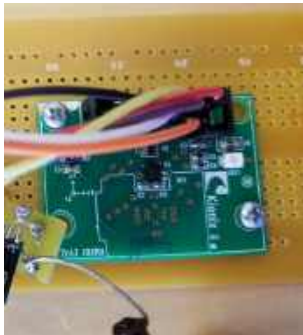

[RF Motion Controlled Robot](#) Introduction For our final project, we designed and implemented a remote-control car with a user-controlled steering wheel interface. We wanted a user interface that was immediately intuitive and familiar, which we thought a steering wheel with an onboard accelerometer definitely accomplished. Additionally, we wanted a..... Listed under: [Robotics - Automation Projects](#)

514.











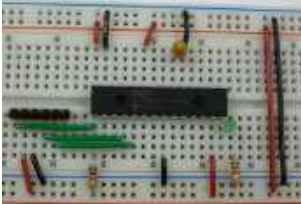

[How to interface keypad with PIC16F84A](#) This post provides a simple method to interface any keypad (e-g 4x4 or 4x3 etc) with PIC16F84A microcontroller. This code is written in C language using MPLAB with HI-TECH C compiler. You can download this code from the 'Downloads' section at the bottom of this page. In this..... Listed under: [Interfacing\(USB - RS232 - I2c -ISP\) Projects](#), [Projects](#)

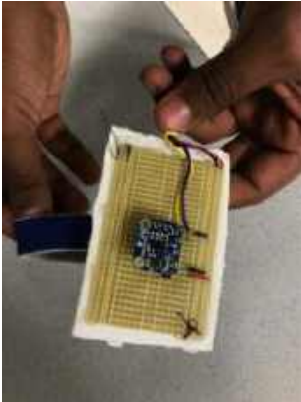
515.

[PIC16F84A based simple calculator \(Code+Proteus simulation\)](#) This post provides a simple calculator implementation for PIC16F84A microcontroller. This is a simple one digit[1] calculator which implements only 4 functions addition(+), subtraction(-), multiplication(x) and division(/). The code for PIC16F84A is written in C language using MPLAB with HI-TECH C compiler. You can download this code from the..... Listed under: [Calculator Projects](#), [Projects](#)



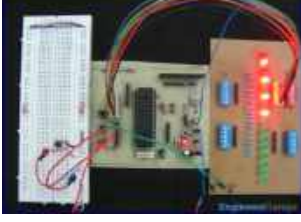

516.  [PIC16F84A interrupt based software UART code and Proteus simulation](#) This post provides the interrupt based software UART (Bit Banging) code for PIC16F84A microcontroller. As we know, PIC16F84A microcontroller doesn't have built in UART module, so we can create UART functionality in it's software. This post provides the details of how to program software UART functionality in PIC16F84A. This code..... Listed under: [Interfacing\(USB - RS232 - I2c -ISP\) Projects, Projects](#)
517.  [PIC16F84A i2c \(bit banging\) code and Proteus simulation](#) This post provides the i2c bit banging code for PIC16F84A microcontroller. As we know[1], PIC16F84A microcontroller doesn't have any built in i2c modules, so we have to create it in the software. This code is written in C language using MPLAB with HI-TECH C compiler. You can download this..... Listed under: [Interfacing\(USB - RS232 - I2c -ISP\) Projects, Projects](#)
518.  [Robot Car Controlled by Hand Motions](#) Introduction: For our final project in ECE 4760: Design with Microcontrollers, we decided to explore the concept of controlling a vehicle with the user's hand orientation relative to the ground. By the end of the semester, we designed a cheap and effective hand controlled vehicle..... Listed under: [Robotics - Automation Projects](#)
519.  [PIC12F675 interrupt based software UART code and Proteus simulation](#) This post provides the interrupt based software UART (Bit Banging) code for PIC12F675 microcontroller. As we know, PIC12F675 microcontroller doesn't have built in UART module, so we can create UART functionality in it's software. This post provides the details of how to program software UART functionality in PIC12F675. This code is..... Listed under: [How To - DIY - Projects, Projects](#)
520.  [PIC12F675 i2c \(bit banging\) code and Proteus simulation](#) This post provides the i2c bit banging code for PIC12F675 microcontroller. As we know[1], PIC12F675 microcontroller doesn't have any built in i2c modules, so we have to create it in the software. This code is written in C language using MPLAB with HI-TECH C compiler. You can download this..... Listed under: [Interfacing\(USB - RS232 - I2c -ISP\) Projects, Projects](#)
521.  [Interfacing of PIC12F675 with DS1307 \(RTC\) code and Proteus simulation](#) This post provides the code for interfacing DS1307 RTC with PIC12F675 microcontroller. This DS1307 RTC has i2c based interface and PIC12F675 doesn't have any built in i2c modules, so software i2c module is created in the code. This code is written in C language using MPLAB with HI-TECH C compiler. You can..... Listed under: [Interfacing\(USB - RS232 - I2c -ISP\) Projects, Projects](#)
522.  [PIC16F877 PWM \(2 channel\) code and Proteus simulation](#) This post answers the question, "How to make a pulse width modulator using PIC16F877" ? Also, using PIC16 simulator (Proteus) you can verify this PWM code and change it according to your needs. You can download the complete project code and Proteus simulation from the 'Downloads' section at..... Listed under: [Projects, PWM Projects](#)
523.  [Autonomously Hovering Quadcopter](#) We designed, constructed and tested an autonomous quadcopter that used an IMU to control its attitude and a radio to transmit data to a controller, which we also built. The project focused on making the quadcopter as autonomous as possible, so only high level commands..... Listed under: [Game - Entertainment Projects](#)
524.  [PIC16F877 external interrupt code and Proteus simulation](#) This post answers the question, "How to capture a pulse to generate an interrupt in PIC16F877" ? Also, using PIC16 simulator (Proteus) you can verify this external interrupt code and change it according to your needs. This code is written in C language using MPLAB with..... Listed under: [Other Projects, Projects](#)
525.  [PIC16F877 UART code and Proteus simulation](#) This post answers the question, "How to use interrupt based UART in PIC16F877" ? Also, using PIC16 simulator (Proteus) you can verify this UART code and change it according to your needs. This code is written in C language using MPLAB with HI-TECH C compiler. You..... Listed under: [Other Projects, Projects](#)

526.  [PIC16F877 LCD interfacing code \(In 4bit mode\) and Proteus simulation](#) This PIC16F877 microcontroller tutorial answers the question, "How to interface LCD[1] in 4bit mode with PIC16F877" ? Also, using PIC16 simulator (Proteus) you can verify this LCD code and change it according to your needs. This code is written in C language using MPLAB with HI-TECH C compiler..... Listed under: [Interfacing\(USB - RS232 - I2c -ISP\) Projects](#), [LCD Projects](#), [Projects](#)
527.  [PIC16F877 based digital clock using LCD display \(Code+Proteus simulation\)](#) This PIC16F877 microcontroller tutorial answers the question, " How to implement a digital clock using PIC16F877 ? " Using PIC16 simulator (Proteus) you can verify this digital clock code and change it according to your needs. This code is written in C language using MPLAB..... Listed under: [Clock and Timer Projects](#)
528.  [LASER HARP](#) THE INTERSECTION OF MUSIC WITH TECHNOLOGY CAN CREATE ENTIRELY NEW WAYS TO PRODUCE OR EXPERIMENT WITH MUSIC. THE RECENT HISTORY OF MUSIC HAS TAKEN ADVANTAGE OF THIS TO AUGMENT EXISTING INSTRUMENTS AND MODIFY THEIR SOUND, OR IN THE CASE OF SYNTHESIZERS, TO PRODUCE ENTIRELY NEW..... Listed under: [Other Projects](#)
529.  [How to interface keypad with PIC16F877](#) This PIC microcontroller tutorial provides a simple method to interface any keypad (e-g 4x4 or 4x3 etc) with PIC16F877 microcontroller. This code is written in C language using MPLAB with HI-TECH C compiler. You can download this code from the 'Downloads' section at the bottom of this..... Listed under: [Interfacing\(USB - RS232 - I2c -ISP\) Projects](#), [Projects](#)
530.  [PIC16F877 internal EEPROM code and Proteus simulation](#) This post provides the internal EEPROM reading and writing code for PIC16F877 microcontroller. As we know[1], PIC16F877 microcontroller has 256 x 8 bytes of built in EEPROM data space with an address range of 0x000 to 0x7FF. This code is written in C language using MPLAB..... Listed under: [Memory - Storage Projects](#), [Projects](#)
531.  [Interfacing of PIC16F877 with \(i2c based\) 24LC64 EEPROM \(Code + Proteus simulation\)](#) This post provides the code for interfacing 24LC64 EEPROM with PIC16F877 microcontroller. This 24LC64 EEPROM has i2c based interface. This code is written in C language using MPLAB with HI-TECH C compiler. You can download this code from the 'Downloads' section at the bottom of this page..... Listed under: [Interfacing\(USB - RS232 - I2c -ISP\) Projects](#), [Memory - Storage Projects](#), [Projects](#)
532.  [Interfacing of PIC16F877 with DS1307 \(RTC\) code and Proteus simulation](#) This post provides the code for interfacing DS1307 RTC with PIC16F877 microcontroller. This DS1307 RTC has i2c based interface. This code is written in C language using MPLAB with HI-TECH C compiler. You can download this code from the 'Downloads' section at the bottom of this page. It is assumed that..... Listed under: [Interfacing\(USB - RS232 - I2c -ISP\) Projects](#), [Projects](#)
533.  [Twitter Emote Robot](#) Introduction Social Media outlets like Twitter and Facebook have become dominating players in the field of human interaction. Indeed many interactions have become mediated by digital technology. We believe the loss of the physical component of interaction has had negative effects on human relationships overall..... Listed under: [Robotics - Automation Projects](#)
534.  [PIC16F877 ADC code and Proteus simulation](#) This post provides the ADC code using PIC16F877 microcontroller. This code is written in C language using MPLAB with HI-TECH C compiler. You can download this code from the 'Downloads' section at the bottom of this page. It is assumed that you know how to interface..... Listed under: [Other Projects](#), [Projects](#)
535.  [PIC16F877 stop watch code and Proteus simulation](#) This PIC16F877 microcontroller tutorial answers the question, " How to implement a stop watch using PIC16F877 ? " Using PIC16 simulator (Proteus) you can verify this stop watch code and change it according to your needs. Using three push buttons (As shown in figure below)..... Listed under: [Clock and Timer Projects](#)
536.  [PIC16F877 up down counter code and Proteus simulation](#) This PIC16F877 microcontroller tutorial answers the question, " How to implement a up down counter using PIC16F877 ? " Using PIC16 simulator (Proteus) you can verify this counter code and change it according to your needs. Using one push button (Labeled as Count, as shown in..... Listed under: [Clock and Timer Projects](#)
537. [PIC16f877 based simple calculator project](#) This PIC microcontroller tutorial provides a simple calculator implementation for PIC16F877 microcontroller. This is a simple one digit[1] calculator which implements only 4 functions addition(+), subtraction(-), multiplication(x) and division(/). The code for PIC16F877 is written in C language using MPLAB with HI-TECH C compiler. You can download..... Listed under: [Calculator Projects](#), [Projects](#)





538. [Project – VR Sword Defense Video Game](#) Introduction In this project, we constructed a virtual reality (VR) video game. The video game uses several peripherals to give the user an immersive gaming experience. This includes providing visual, auditory, and tactile feedback from the game. The game features a headpiece with a TFT..... Listed under: [Game - Entertainment Projects](#)



539. [How to display text on 16x2 LCD using PIC18F4550](#) Several automated and semi-automated devices require a message to be displayed in order to indicate their working status. In continuation to LCD interfacing with PIC18F4550, this article explains how to display a message or string on a 16x2 character LCD. In the previous article, a..... Listed under: [LCD Projects](#), [Projects](#)



540. [PIC Microcontroller timer Video Project](#) PIC Microcontroller timer/counter by Dr. Tom Lombardo ... Listed under: [Clock and Timer Projects](#)



541. [UFO round LED Chaser with speed control for PIC16F628A](#) Description This is an updated version of the UFO LED Chaser project, revised to use the PWM LED Chaser code version 3.0.0 with support for variable chase speed. The basic LED chaser 'engine' firmware is the same as that used with the 481/483 LED chaser..... Listed under: [LED Projects](#), [Projects](#)

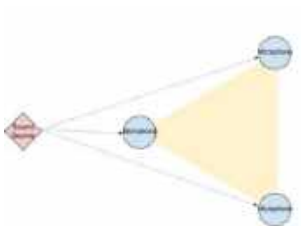

542. [Sound Localization](#) INTRODUCTION We constructed a triangular arrangement of microphones to localize the direction an arbitrary sound is coming from. By recording input from the three microphones, we can cross-correlate the recordings to identify the time delay between the audio recordings. Since the physical placement of the..... Listed under: [Sound - Audio Projects](#)



543. [UFO round LED Chaser Kit for PIC16F628A](#) Description This page is has been written to support construction of the UFO LED Chaser Kit #432K. This neat little circuit provides 8 LEDs directly driven from the PIC along with a single mode control switch. The firmware elsewhere on this page drives the LEDs..... Listed under: [Development Board - Kits Projects](#), [LED Projects](#), [Projects](#)



544. [8 Channel PWM LED Chaser for PIC16F628A and PIC16F88](#) Description This neat little circuit provides 8 LEDs directly driven from the PIC along with a single mode control switch. The firmware elsewhere on this page drives the LEDs with a 5 bit PWM signal providing each of the 8 LED channels with four levels..... Listed under: [LED Projects](#), [Projects](#)



545. [8 Channel PWM Power MOSFET LED Chaser for PIC16F628A](#) Description Update: Variable chase speed option kit now available (see here for details) This neat little circuit provides 8 LEDs directly driven from the PIC along with a single mode control switch. The firmware elsewhere on this page drives the LEDs with a 5 bit..... Listed under: [LED Projects](#), [Projects](#), [PWM Projects](#)



546. [8 Channel PWM LED Chaser for PIC16F628A](#) Description Update: Variable chase speed option kit now available (see here for details) This neat little circuit provides 8 LEDs directly driven from the PIC along with a single mode control switch. The firmware elsewhere on this page drives the LEDs with a 5 bit..... Listed under: [LED Projects](#), [Projects](#), [PWM Projects](#)

547. [Electronic Flute](#) High-level Design The goal of this project is to create an electronic flute. The musical instruments like keyboards, guitars, etc. have adjustable keys in order to play sounds at different scales. However, flutes are designed for only one scale and therefore need to be changed..... Listed under: [Sound - Audio Projects](#)



548.

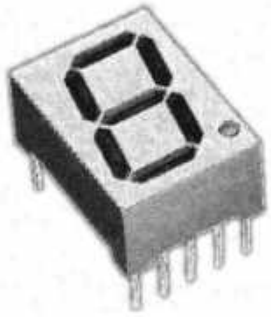

[Binary/bcd to 7-segment decoder for PIC16F627A](#) Overview This is a building block project I developed to try out a few ideas. It decodes a 4-bit binary word to outputs that will drive a 7-segment LED display. Functionality is similar to the 7447 BCD-to-seven-segment decoder/driver IC however, because it's implemented using a..... Listed under: [LED Projects](#), [Projects](#)

549.

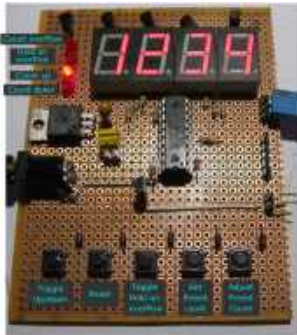

[4-digit Up/Down counter with preset, reset, hold and overflow output using PIC16F88](#) Overview A four digit decimal counter for the PIC 16F88 with the following features: Count up / down Reset Free running or hold on count over/underflow User count preset Over/underflow output Description This is a 4 digit decimal counter which can operate as a free..... Listed under: [Clock and Timer Projects](#)

550.



[4 Channel DMX512 Driver for PIC16F1823](#) The original DMX512 driver project #800 is now redesigned to incorporate the optional address configuration switch on the main PCB. The no-switches in-band DMX configuration feature is still retained Double sided PCB has resulted in a more compact board size. Firmware has been updated to run..... Listed under: [Development Board - Kits Projects](#), [Projects](#)

551.



[RGB LED Strip Controller high-side LED drive for PIC12F629](#) Recently I acquired a 5M length of RGB LED strip using SMD5050 RGB LEDs. It has built in current limit resistors designed for operation from a 12 volt supply. Having thought this would directly attach to the Picprojects MOSFET RGB LED driver project I went..... Listed under: [LED Projects](#), [Projects](#)

552.

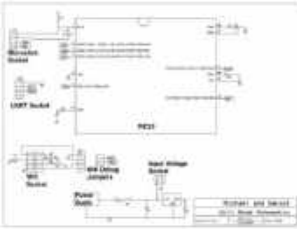

[SELF ORGANIZING WIFI MESH NETWORK](#) Overview In this project, we create a mesh network of PIC32 microcontrollers connected using ESP8266 wifi modules. The mesh network is able to fully connect itself through a variety of graph topology algorithms and is able to route packets through the network using a shortest..... Listed under: [Wifi - WLAN Projects](#)

553.



[RGB LED PWM Driver Standalone PWM controller for RGB LEDs using PIC12F629](#) Want to build an RGB LED controller that you can program with your own custom sequences and effects? Then read on. The RGB LED controller has proved to be very popular project and has been the most frequently downloaded code on the site since it..... Listed under: [LED Projects](#), [Projects](#), [PWM Projects](#)

554.



[Pickit 2 Download & Develop Your own USB pickit ii programmer](#) PICKIT 2 Introduction: There are many PIC programmer available, commercial and DIY devices. As Microchip introduces the new microprocessors the programming software got to be updated accordingly playing catch-up with the PIC manufacturer. That is the root of the problem with third-party PIC programmers..... Listed under: [How To - DIY - Projects](#), [Microcontroller Programmer Projects](#), [Programmers](#), [Projects](#)

555.



[OBD-II ELM327 compatible AllPro adapter using PIC18F2455](#) Overview This adapter allows you to interface with your car's OBD-II bus. It provides you a USB interface using the ELM327 command set and supports all major OBD-II standards: SAE J1850 PWM SAE J1850 VPW ISO 9141-2 ISO 14230-4 ISO 15765-4 CAN Hardware The adapter kit..... Listed under: [Car Projects](#), [Interfacing\(USB - RS232 - I2c -ISP\) Projects](#), [Projects](#)

556.

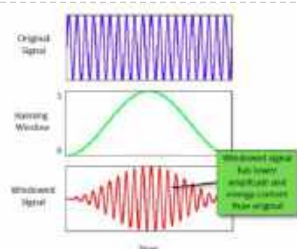

[Spectrum Analyser](#) Introduction The webpage describes the development of an Audio Spectrum Analyzer based on PIC32 microcontroller with the following features: [embed]https://youtu.be/cuPJKI3xMOE[/embed] Real time speech signal acquisition Spectrum and spectrograph visualization of Mel Frequency bands Serial interface for forwarding Mel Frequency Band Power Spectrum coefficients Recording and..... Listed under: [Sound - Audio Projects](#)

557.

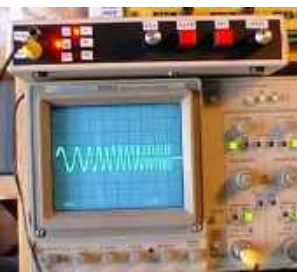

[Function Generator using PIC16F870 microcontroller](#) Sine Triangle Square Saw Burst Sweep Noise - runs on a PIC16F870 After the recent demise of our multifunction signal generator, we decided to make one of our own. The circuit uses a PIC16F870 (about \$3), an R/2R resistor ladder network (for a real fast..... Listed under: [Metering - Instrument Projects](#), [Projects](#)



- 558.



[Tiny GSM alarm system using PIC16F84A](#) After GSM call alarm and GSM SMS alarm as two independent modules, I introduce the Tiny GSM alarm system. The main characteristic of this new version is that this device can operate standalone or as a module for existing alarm system. In previous versions we had only the "enable" pin..... Listed under: [Phone Projects](#), [Projects](#), [Security - Safety Projects](#)
- 559.

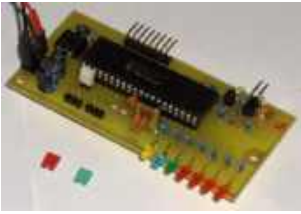

[SMS Box project using PIC16F877A Microcontroller](#) This device acts as interface between your microcontroller project and a GSM phone. It handles all modem data communication between the GSM phone and your micro-project. The best thing is that it decodes PDU into TEXT on the fly! You can easily SMS-enable your any..... Listed under: [Phone Projects](#), [Projects](#)
- 560.

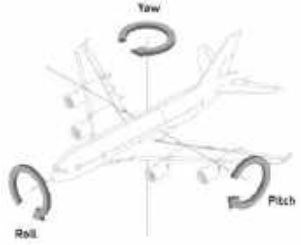

[2-Axis Gesture-Controlled Camera Platform](#) Introduction For the ECE 4760 final project, we designed and implemented a 2-axis gesture-controlled platform for DSLR cameras. The platform can actuate a camera based on the orientation of the user's hand with relative high accuracy and low latency. Our 2-DOF gesture-controlled platform can point..... Listed under: [Video - Camera - Imaging Projects](#)
- 561.



[Home Automation and Safety via GSM Remote](#) Objectives: To test a level of understanding for my final year project. To present about programmable control home safety via gsm modem; the performance or what have been achieved. To improve myself, in term of knowledge, presentation and communication. Content / Procedure: Refer to FYP..... Listed under: [Home Automation Projects](#), [Projects](#)
- 562.



[LC meter using PIC16F628A Microcontroller](#) I needed a good LC meter for my one of my next projects so I went and built the famous LC meter by Phil Rice. This LC meter design is pretty old but since it is a perfectly good device there was no need to..... Listed under: [Metering - Instrument Projects](#), [Projects](#)
- 563.



[Build a digital clock with its digits levitating in the air using PIC16F84](#) Red digits on this photo appear to float in the air in front of the clock. This illusion is based on inertia of a human eye. If LED-formed digits will periodically and frequently enough flash, they will appear solid and steady. And since the matrix..... Listed under: [Clock and Timer Projects](#)
- 564.



[Digital Oscilloscope using PIC16F688](#) Far and away my most ambitious project to date, this digital oscilloscope can sample up to four channels at a rate up to 100kHz. And the best part? It only cost me about \$40 in components. The user interface is an application running on a..... Listed under: [Metering - Instrument Projects](#), [Projects](#)
- 565.



[Web Controlled Multifunctional Car](#) Introduction In our final project, we have built a multi-functional car controlled by a web application on the PC, which allows users to drive the car as well as play music from the interface on the website. All the requests from the website are collected..... Listed under: [Development Board - Kits Projects](#)
- 566.



[Gear Clock using PIC16F676 Microcontroller](#) I can't take credit for the design of this one. I bought the gear as a clock a few years ago. It was mounted on a frame and had one of those cheap clock units running it. The gear is designed to be driven by..... Listed under: [Clock and Timer Projects](#)
- 567.



[Distributed PIC Synthesizer](#) Introduction In this project, I have created a musical synthesizer with the ability to generate realistic instrumental sounds and to record songs for playback with harmonization. Controlled by a PIC32 microcontroller, the synthesizer has over a full octave of buttons, laid out like a piano,..... Listed under: [Other Projects](#)
- 568.

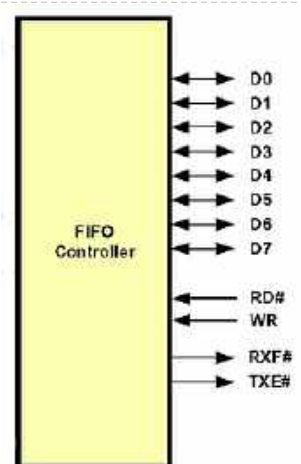



[Microchip pic16f877 to FTDI USB interface](#) Introduction This is a simple design that interfaces a PIC 16F877 microcontroller to the USB bus using the FTDI FT245 USB FIFO device. It has been designed using a simple single sided PCB with only one surface mount device, the USB chip itself. All schematics,..... Listed under: [Interfacing\(USB - RS232 - I2c -ISP\) Projects](#)
- 569.





[Rs 232 Relay Control Board using PIC16F84A](#) Project Summary Computer Controlled, relay board designed to be either operated manually via switches on the board or nine way Type Connector via PC or laptop. Provision has been made for USB serial adaptor. The Project utilises PIC Micro technology with windows visual interface written..... Listed under: [Development Board - Kits Projects](#), [Projects](#)

570. [Make your own PIC Programmer using PIC12C508](#) ezPIC is low cost serial port programmer for PIC microcontroller and I2C EEPROM. The programmer does not need external power supply and it takes all necessary power and signal from RS232 Serial Port. Features \* No external power supply required \* High quality 3M ZIF..... Listed under: [Microcontroller Programmer Projects](#), [Projects](#)

571.  [Electronic combination lock based on PIC16f84](#) description This is my electronic combination lock to use with an outdoor gate. The functionality is implemented in software. It turns on a relay (usually to open a door) for a few seconds if someone enters the valid code. Alternatively, it works as an ON/OFF..... Listed under: [Projects](#), [Security - Safety Projects](#)

572.  [Happy Little Mixer](#) Introduction The Happy Little Mixer is an automatic ink mixer which accepts a hex user input and creates that color by measuring out cyan, magenta, yellow, and black (CMYK) ink. It includes open-loop feedback using a color sensor to correct the generated color, making it..... Listed under: [Home Automation Projects](#)

573.  [Line following robot using PIC16F84](#) Design Goal: The JavaBot1 is a small line following robot designed to follow a black line drawn on a dry erase board. It is designed to follow very tight curves. The software still has lot's of room for improvement but works well as is. Motive..... Listed under: [Projects](#), [Robotics - Automation Projects](#)

574.  [Propeller Clock Mechanically Scanned LED Clock using PIC16C84](#) This is the first clock I ever built. I've built a few LED signs, but they get boring because I already know the message. How this clock works: A motor spins the "propeller", and a small microprocessor keeps track of time and changes the pattern..... Listed under: [Clock and Timer Projects](#), [LED Projects](#)

575.  [Digital Thermometer Using PIC16F688 microcontroller](#) Digital thermometers are cool devices as they show temperatures in human readable formats. This digital thermometer project is based on a PIC16F688 microcontroller and a DS1820 temperature sensor, and it displays temperature on a character LCD screen in both Celsius and Fahrenheit scales. I selected..... Listed under: [Projects](#), [Temperature Measurement Projects](#)

576.  [Wireless MultiMeter using PIC18F452 Microcontroller](#) This project comes as a KIT. It includes these components: Low-cost DMM (digital multimeter) M830D TX (transmitter) circuit and wireless module TX-433. These are mounted within the DMM housing. RX (receiving) circuit with a wireless module RX-433, LCD and piezo buzzer. The general idea is to read..... Listed under: [Metering - Instrument Projects](#), [Projects](#), [Radio Projects](#)

577.  [Microcontroller based Diode and Bipolar Junction Transistor \(BJT\) tester using PIC16F688](#) Introduction Most of the digital multimeters these days have built-in features for testing diodes and sometimes transistors. The purpose of this project is to demonstrate a simple way to construct a testing device for diodes and bipolar junction transistors (BJTs) using a microcontroller. The testing..... Listed under: [Metering - Instrument Projects](#), [Projects](#)

578.  [ECE 4760 Project: Kendo Sword Trainer](#) Introduction For our final project, we built a system to aid in practicing kendo sword strikes by providing feedback to a kendo practitioner for improving their form. A set of three piezoelectric sensors on a helmet were used to detect the location and strength of..... Listed under: [Other Projects](#)

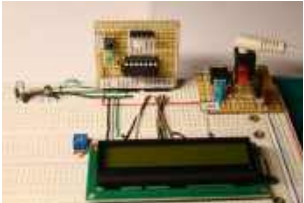
579.  [A Digital temperature meter using an LM35 temperature sensor using PIC16F688](#) Introduction A digital thermometer is a good choice of project for beginners who just stepped in to the world of microcontrollers because it provides an opportunity to learn using sensors to measure the real world signals that are analog in nature. This article describes a..... Listed under: [Metering - Instrument Projects](#), [Projects](#), [Sensor - Transducer - Detector Projects](#), [Temperature Measurement Projects](#)

580.  [Experimenting with a thermistor using PIC16F1937](#) Recently i won a bid for a batch of 10K thermistors. The only thing that i knew when i got them in my hand, was that those things are 10K thermistors. As far as i know, the 10K nominal resistance is at room temperature (25°C)..... Listed under: [Metering - Instrument Projects](#), [Projects](#), [Temperature Measurement Projects](#)

581.  [VGA display using PIC18F452 microcontroller](#) For quite some time I've been wanting to create a device that outputs VGA signals. My main goal was of course to be able to display whatever I wanted on the monitor I was currently using. After extensively researching to see if this project had..... Listed under: [LCD Projects](#), [Projects](#)

582. [2 Digit up/down Counter using PIC16F628A](#) This project comes via two circuits on 2 boards. The first circuit is designed around a PIC16F628A. It has been presented on an experimental PC board using surface-mount components and was built in less than 1 hour, with about 2 hours to





write and finalise..... Listed under: [Clock and Timer Projects](#)

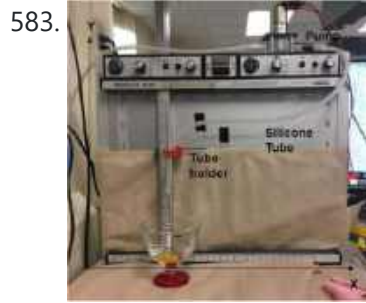

583. [ECE 4760: Latte Art Machine](#) Introduction For our final project ECE4760: Microcontrollers, our group created a cappuccino art designer that would automatically pour milk into coffee, while creating the classical latte art design. For this project, our group used a Houston Instrument Omnigraphic 2000 X-Y Plotter and a peristaltic pump..... Listed under: [Other Projects](#)



584. [Wifi robot vehicle controlled by PIC16F628A](#) Introduction Wifi Robot: A remote control car that can be driven over the internet or with a laptop wirelessly from up to 500m away. It has a live-feed network camera so that it can be driven without line of sight and a horn so that..... Listed under: [Internet - Ethernet - LAN Projects](#), [Projects](#), [Robotics - Automation Projects](#)



585. [Motion detection alarm using a PIR sensor module with a PIC12F635](#) Introduction This project describes a motion sensor alarm based on a Passive Infra-Red (PIR) sensor module. There are many vendors that manufacture the PIR sensor modules and almost all of them are pretty much the same in function. They have a single output that goes..... Listed under: [Projects](#), [Security - Safety Projects](#), [Sensor - Transducer - Detector Projects](#)



586. [HAPPY BIRTHDAY using PIC12F629 Microcontroller](#) Why spend \$10.00 on a Happy Birthday musical card when you can produce the tune yourself. This project uses just 4 components and a small prototype PC board to produce a project that will teach you a lot about programming. The circuit uses a piezo..... Listed under: [Game - Entertainment Projects](#), [Home Automation Projects](#), [Projects](#)

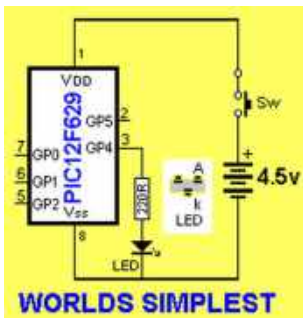

587. [WORLD'S SIMPLEST PROGRAM using PIC12F629](#) This is where you start with programming. Build the PIC Programmer MkV and build the World's Simplest circuit on a PC board for a PIC12F629 chip, LED and resistor. When the World's Simplest Program is "burnt" into the chip, the LED will flash. This is..... Listed under: [Microcontroller Programmer Projects](#), [Projects](#)



588. [Drawing Bot 1](#). Introduction For our final project, we designed a drawing robot that can turn any computer image into line drawings. Our drawingbot features a pen that moves up and down, a base plate with a piece of paper attached that moves in the x-y plane..... Listed under: [Other Projects](#)



589. [Programmable digital timer switch using a PIC16F628A](#) Digital timer switches are used to control the operation of electrical devices based on a programmed schedule. This project describes a programmable digital timer based on a PIC16F628A microcontroller that can be programmed to schedule the on and off operation of an electrical appliance. The..... Listed under: [Clock and Timer Projects](#)



590. [Digital alarm clock using PIC16F877 microcontroller](#) This is an alarm clock I built. It was very effective during the sort time I used it, because I programmed it to play a very annoying tune through a speaker. I actually started to wake up before the alarm went of, so other people..... Listed under: [Clock and Timer Projects](#), [Home Automation Projects](#)

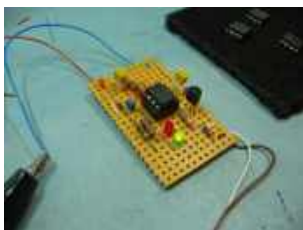

591. [Internal Oscillator Recalibration Utility for PIC12F629](#) Description The PIC 12F629 and 12F675 come equipped with an internal 4MHz oscillator, eliminating the need for an external crystal or RC network. This feature not only frees up one or two pins for I/O purposes but also facilitates integration into designs with minimal component..... Listed under: [Clock and Timer Projects](#)

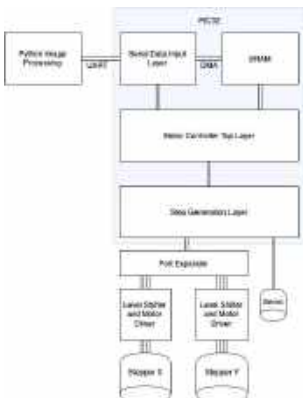

592. [Bot Ross](#) Introduction Bot Ross is a moderately sized 2-D contour plotter, capable of drawing images with a resolution of roughly 1 mm. The design consists of a pen with degrees of freedom in the x and y directions, actuated using threaded rods controlled by two stepper..... Listed under: [Other Projects](#)

593. [IR Remote Control Repeater using PIC12F629](#) This circuit receives the signal from a IR remote control, like those used to control your TV or DVD player and allows the signal to be repeated in another location. To get a 40Khz carrier requires an output to be toggled on and off 40,000.....



Listed under: [Internet - Ethernet - LAN Projects, Projects](#)

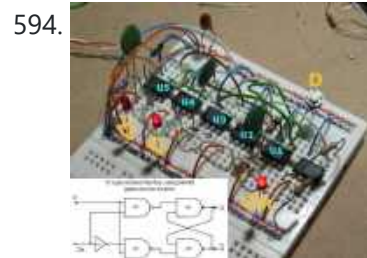

594. [PIC12F675 microcontroller as Flip Flop](#) Code to make a 12F675 operate as a D-type or JK-type flip flop Since I implemented a D type flip flop using the PIC Logic Elements I thought I might go the other way and implement an entire D type flip flop in a single..... Listed under: [Other Projects, Projects](#)



595. [Heart rate measurement from fingertip using PIC16F628A](#) Introduction Heart rate measurement indicates the soundness of the human cardiovascular system. This project demonstrates a technique to measure the heart rate by sensing the change in blood volume in a finger artery while the heart is pumping the blood. It consists of an infrared..... Listed under: [Medical - Health based Projects, Projects](#)

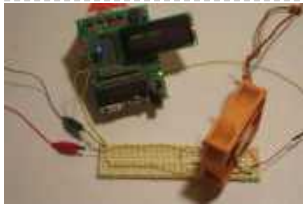

596. [Build A Digital Tachometer/RPM Counter using PIC18F452](#) A tachometer is a tool that mechanics or engineers in general use very often. A normal tachometer will be able to tell you how fast something is moving in a complete rotation. A good example is on cars, you will see a tachometer counting the..... Listed under: [How To - DIY - Projects, Metering - Instrument Projects, Projects](#)

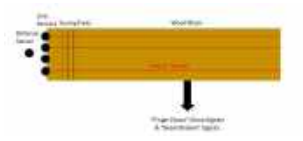

597. [AIR BASS](#) INTRODUCTION AirBass is an air bass guitar that allows the user to play distinct notes without the added weight and cost of an actual bass guitar. It implements various sensors for input to output sound that is accurate both in terms of frequency and duration..... Listed under: [Sensor - Transducer - Detector Projects](#)



598. [A Beginner's data logger project using PIC12F683 microcontroller](#) It is a very simple data logger project based on PIC12F683 microcontroller. The microcontroller reads temperature values from a temperature sensor on a regular interval basis and stores them into its internal EEPROM memory. The recorded temperatures can be later transferred to a PC through..... Listed under: [Memory - Storage Projects, Projects, Temperature Measurement Projects](#)

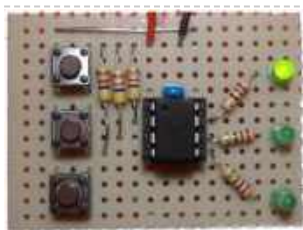

599. [Radio Button Switch Control using PIC12F629](#) Overview The original purpose behind this circuit was to provide manual switching of three relays such that only one relay was on at any time. It was also a requirement that there was a specific overlap (or make-before-break) period. The code was then further developed..... Listed under: [Projects, Radio Projects](#)



600. [PWM DC Motor Controller for PIC12F683](#) Description There are lots of designs on the Internet for DC power controllers using Pulse Width Modulation (PWM) to control the speed of a motor or power to a resistive load. Most of these use analogue methods to generate the PWM signal which in turn..... Listed under: [Motor Projects, Projects, PWM Projects](#)

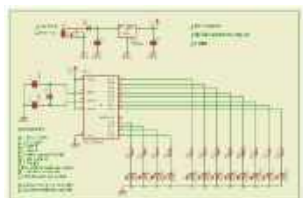

601. [LED Chaser for PIC16F84A and PIC16F628A](#) Description This simple circuit functions as a 12 LED chaser. A single illuminated LED 'walks' left and right in a repeating sequence, similar to the effect seen on KITT, the car in the Knight Rider TV series. Fully commented source code and programmer ready HEX..... Listed under: [LED Projects, Projects](#)



602. [EEG Error Correction Interface](#) Introduction Our project was an EEG-controlled brain computer interface that allowed a user to correct errors in machine behavior. The project was modeled as a trial-based "game." In each trial, a solid colored green block or dotted yellow block was placed on a conveyor belt..... Listed under: [Sensor - Transducer - Detector Projects](#)



603. [How to make a contact-less digital tachometer using IR-light reflection technique using PIC18F2550](#) Tachometer is a device that measures the rotational speed of any shaft or disc. The unit of the measurement is usually revolutions per minute or RPM. The traditional method of measuring RPM of a rotating shaft was based on velocity feedback concept where a dc..... Listed under: [CNC Machines Projects, Metering - Instrument Projects, Projects](#)











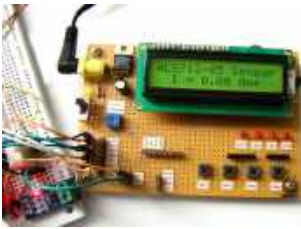
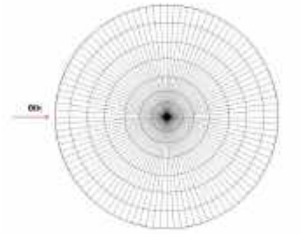

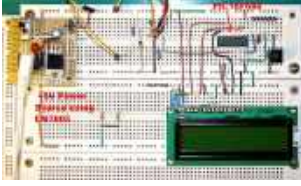











604. [The Outlet Nanny](#) We designed a power monitor that could communicate with the PIC32 through UART to give both power and current readings for any device(s) (that use NEMA plugs) plugged into our box. These readings are then accessible on a website interface, on a graph. We chose..... Listed under: [Other Projects](#)



605. [Measurement of temperature and relative humidity using DHT11 sensor and PIC microcontroller using PIC16F628A](#) Measurement and control of temperature and relative humidity finds applications in numerous areas. These days devices are available which have both temperature and humidity sensors with signal conditioning, ADC, calibration and communication interface all built inside them. The use of such smart sensors greatly simplify..... Listed under: [Projects, Sensor - Transducer - Detector Projects, Temperature Measurement Projects](#)



606.  [A brief overview of Allegro ACS712 current sensor using PIC16F1847 \(Part 2\)](#) In the first part of this discussion, the features of ACS712 device were briefly discussed. Now we will use that theory to implement the ACS712 sensor to make a simple DC current meter. The analog output voltage from the sensor is measured through an ADC..... Listed under: [Projects, Sensor - Transducer - Detector Projects](#)
- 
607.  [Persistence of Vision \(POV\) Dino Game](#) Introduction Our project is a persistence of vision styled dinosaur game. Our team was really intrigued by POV displays and we wanted to explore how POV works. That's what led us to this project. Unlike most POV projects we have seen on the internet that..... Listed under: [Game - Entertainment Projects](#)
- 
608.  [Making a digital capacitance meter using PIC16F628A](#) Capacitors are one of the most common passive electrical components that are extensively used in all kinds of electronic circuits. In this project, we will discuss a technique of building a digital capacitance meter using a PIC microcontroller. This project can measure capacitance values from..... Listed under: [Metering - Instrument Projects, Projects](#)
- 
609.  [Digital Voltmeter \(DVM\) using PIC16F688](#) Introduction This project will describe how to make a simple digital voltmeter (DVM) using a PIC16F688 microcontroller. The range of this DVM is 0-20V, but you can easily increase or decrease the range of input voltage as your requirements after you understand the voltage scaling..... Listed under: [Metering - Instrument Projects, Projects](#)
- 
610.  [PIC16F84A Temperature Controller](#) Ever needed to measure temperature and display it? This project details measuring temperature using a temperature sensor ,an ADC and a Microcontroller PIC16f84a with schematics,codes and illustrations. You can also get the following kit, although not based on the pic, which would make your life..... Listed under: [Projects, Temperature Measurement Projects](#)
- 
611.  [pic12f683 Microcontroller based Programmable LED](#) Alex Weber over at Instructables built a great programmable LED based on the AVR chip. Since I am tooled for PIC, I thought it would be fun to replicate what he has done. This simple project is fun and it provides a great building block..... Listed under: [LED Projects](#)
- 
612.  [DotStar Light Painter](#) High Level Design The painting is created by a vertical pole with a flashing one-meter LED strip attached to a cart being pushed by two motors. A user can use their DSLR camera to view the long exposure effect. To upload an image, the user..... Listed under: [LED Projects](#)
- 
613.  [pic18f458 Microcontroller based Solar Recorder](#) The device used for measuring daily insolation has been developed. The device was built with a PIC18F458 and the 128MB Multimedia Memory Card, MMC. The solar radiation is measured by a calculator solar cell. The PIC chip interfaces the MMC using SPI mode. The interval..... Listed under: [Sensor - Transducer - Detector Projects](#)
- 
614.  [PIC Based Speed Controller using PIC16C54](#) Introduction Real world applications often call for controlling small to medium sized DC motors from digital circuits. For smaller motors it is usually economically infeasible to buy a commercial speed controller as the cost of the controller will far outstrip the cost of the motor..... Listed under: [Game - Entertainment Projects, Interfacing\(USB - RS232 - I2c -ISP\) Projects, Other Projects](#)
- 
615.  [Stepper Motor Controller using pic16f628a](#) Since I finished my degree in April, I have been looking for work. The search has been slow but hopefully soon I will be making the big bucks. To fill my spare time I decided to do something with the mounds of electronics and such..... Listed under: [Motor Projects](#)
- 
616.  [Make your own USB LCD controller using PIC18F2550](#) Hi everybody Ages and ages ago, I posted this and many people said they'd like a guide. So here it is! This is a guide for making an LCD that connects to your computer using USB, primarily intended to be external. You can see mine..... Listed under: [How To - DIY - Projects, Interfacing\(USB - RS232 - I2c -ISP\) Projects, LCD Projects, Projects](#)
- 
617.  [THE SKY WRITER](#) We created Skywriter because lightsabers are cool. Although we are fans, we are not passionate about the Star Wars franchise. However, we are passionate about the technology in Star Wars. For our final project, we wanted to replicate the futuristic lightsaber. And add a twist..... Listed under: [LED Projects](#)

618.  [Intelligent NiCd/NiMH Battery Charger using PIC16C711](#) This cheap and easy to build NiCd/NiMH Battery Charger is suitable for automatically charging a wide range of batteries for many applications. Proper chargers are usually expensive and cheap chargers supplied with the original equipment often incorrectly charge the cells and dramatically shorten their life..... Listed under: [Battery Projects](#), [Projects](#)
- 
619.  [2.5 GHz Frequency counter using PIC16F870](#) Background It is time to update the frequency counter again. A frequency counter is one of the most important measuring tool we need as homebrewers of RF electronic. This frequency counter has very high performance and still is very easy to build and to use..... Listed under: [Clock and Timer Projects](#)
- 
620.  [Universal RC5/RC6 transceiver using PIC16F628](#) This project is an expansion from another project from this website. On the one side you can read the RC5, RC5X and RC6 codes from remote controls on a LCD and on the other hand you can send all thinkable RC5, RC5X and RC6 codes..... Listed under: [Projects](#), [Radio Projects](#)
- 
621.  [Universal Infrared Receiver using PIC16F84 and PIC12C508](#) The UIR is a device that enables you to control your PC with ANY remote controller you have (TV, VCR, CD or Stereo). Original hardware & software was designed by Martinus & Ties Bos. You should check their site first. There it was, now it..... Listed under: [Interfacing\(USB - RS232 - I2c -ISP\) Projects](#), [Internet - Ethernet - LAN Projects](#), [Projects](#), [Radio Projects](#)
- 
622.  [Play Your Cards Right](#) Introduction The purpose of this lab is to build a machine that alleviates the process of distributing cards in gameplay with a given set of players in random order. Our team has successfully built a prototype of such a device that takes in a deck..... Listed under: [Other Projects](#)
- 
623.  [IK3OIL 16F84 PIC Frequency Counter Files](#) Caption (copied from the NorCal meeting listed in the links below): IK3OIL Frequency counter built by Wayne McFee. This is from IK3OIL's web site, and the cost of the counter was about \$2, minus the display, which was about \$7. Wayne got the source was..... Listed under: [Clock and Timer Projects](#)
- 
624.  [Ir Light Dimmer v.1 adjusting lights with remote controller using PIC12F629](#) This is a device for adjusting lights in your home with any type of remote controller (tv, dvd, video,...). Today we are using many devices in our homes to improve quality of our life and this is another example on how you can enhance a..... Listed under: [Home Automation Projects](#), [Projects](#)
- 
625.  [My GPS LCD Display Project using PIC16F84](#) This is a project that I started back late 2003 when I just starting to learn PIC programming. I wanted to building something that actually did something useful. This project is based on a PIC16F84. I actually came up with this idea and then after..... Listed under: [GPS Based Projects](#), [LCD Projects](#), [Projects](#)
- 
626.  [PIC32 Racing Game](#) Introduction Our project is a racing game with human input control that emulates the act of driving a car. We decided on this project, as all three of us greatly enjoy playing games. The goal of the game is to cross the finish line in..... Listed under: [Game - Entertainment Projects](#)
- 
627.  [Simple RF/Microwave Frequency Counter using PIC16F876A](#) 2. Counter The whole counter design is based on the PIC micro-controller 16F876A. The latter includes several peripherals and just a few of them are used in this project. The most important in this project are two internal, hardware counters/timers called TMR0 and TMR1. The..... Listed under: [Clock and Timer Projects](#), [Sensor - Transducer - Detector Projects](#)
- 
628.  [LCD Oscilloscope for Spectrum Analyzers using PIC16F876A](#) 1. Spectrum-analyzer project 2007 update Since the development of the wide-band VCO almost 10 years ago, the whole spectrum-analyzer project with all related accessories: tracking generator, harmonic converter, storage-normalizer, marker counter and accessories developed by other experimenters (Darko S57UUD) have been published in many different..... Listed under: [LCD Projects](#), [Projects](#)
- 
629. [LM75 Temperature Sensor with 7 segment display output using PIC16F628](#) This is a test project built hastily on a solder less breadboard. It uses a LM75 to read the current temperature via I2C and displays the result on three 7 segment displays. It uses a PIC16F628 with an internal 4 Mhz clock. The program was..... Listed under: [Projects](#), [Sensor - Transducer - Detector Projects](#), [Temperature Measurement Projects](#)



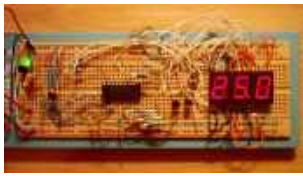

630.

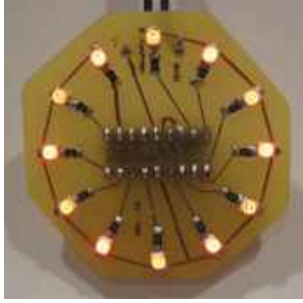

[Medallion: Circle LED Animation PIC16F628A](#) This project uses the Simple LED Animation Kit (SLAK post or page) with the LEDs arranged in a circle around the PIC16F628A. I decided to do this project after picking up some red SMD LEDs at HSC in Santa Clara, CA, last week. Although the..... Listed under: [Game - Entertainment Projects](#), [Home Automation Projects](#), [LED Projects](#), [Projects](#)

631.

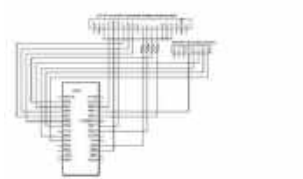

[Traffic Light Intersection Simulator](#) Introduction The Traffic Light Intersection Simulator records user input through a touch screen of traffic flow at a four-way intersection for play back. Additionally it is capable of storing and reading to a FAT 32 formatted microSD card. The simulator is also capable of clearing..... Listed under: [LED Projects](#)

632.

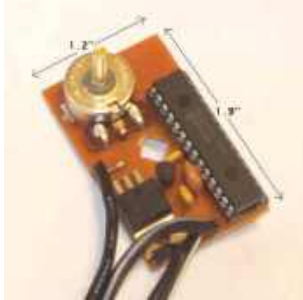

[DC motor speed control using PWM using PIC16F876](#) If you do not have EAGLE, you can download a full working version from CadSoftUSA <http://www.cadsoftusa.com> Here is a zip file with the EAGLE schematics and PCB layout. <http://hans-w.com/MotorSpeedEAGLE.zip> New ! Source code available C source code... requires CCS PCM compiler. PCM is available from..... Listed under: [Motor Projects](#), [Projects](#), [PWM Projects](#)

633.



[Caller Line Identification \(CLI\) using PIC16F628A](#) 'Caller Line Identification' displays on a (2x16) LCD the phone number of the person who is ringing you, before you even answer. When start up the first few seconds appears the version number in the display. Direct after programming the PIC stays in TEST-mode. You..... Listed under: [Phone Projects](#), [Projects](#)

634.



[Serial Port Servo Controller using PIC16F84](#) Revision History 28 Jan, 2002 - Bug found in 8 Servo motor variant, refer to 8 servo code page for details. 28 Oct, 2001 - Serial Transfer Bug found. Dec, 2005 - This project is no longer supported. The information is here for you to..... Listed under: [Interfacing\(USB - RS232 - I2c - ISP\) Projects](#), [Motor Projects](#), [Projects](#)

635.



[PIC Based Imaging Sonar using PIC16F84 microcontroller](#) I've wanted to build a sonar for a while now, and I was hoping to be able to do it with a design someone else had made, but alas, I've never had much luck. I've done many searches of web pages, and all that ever..... Listed under: [Projects](#), [Sensor - Transducer - Detector Projects](#), [Video - Camera - Imaging Projects](#)

636.



[Designing a PID Motor Controller using PIC16F876](#) Background From the first robot I ever made, I have always felt that when designing the motors, wheels and drive train, it will almost always be important to know where you are - that is, to have some sort of encoder feedback. So the first..... Listed under: [Motor Projects](#), [Projects](#)

637.

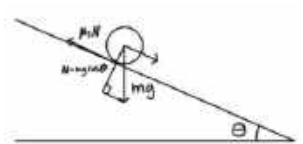

[A Two-Degree-Of-Freedom Ball Balancing PID Controller](#) Introduction In this project, we implemented a two-degree-of-freedom ball balancing platform using a resistive touchscreen, two servo motors, and PID control. We used a PIC32 microcontroller to read position data from the touchscreen and drive the servos, adjusting the platform's angle. We tuned the system..... Listed under: [Other Projects](#)

638.



[Direct Digital Synthesis \(DDS\) using PIC16F84 microcontroller](#) Background DDS stands for Direct-Digital Synthesis. This synthesizer is simply a circuit that can create a sine-wave signal from a reference crystal and a programmable frequency-register. All this circuit needs is a reference oscillator (crystal) and some filter. See fig above: A crystal oscillator..... Listed under: [Other Projects](#), [Projects](#)

639.









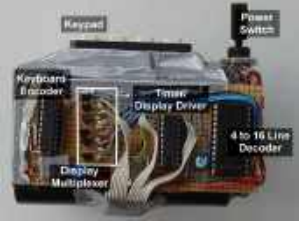

[DDS/PLL based VFO synthesizer using PIC16F876](#) DDS (Direct Digital Synthesized) VFO seems to be very popular among amateurs in last few years, mainly thanks to cheap and easy available single-chip DDS synthesizers. There are plenty of different amateur designs, some of them also available in a KIT form. They mostly use..... Listed under: [Other Projects](#), [Projects](#)

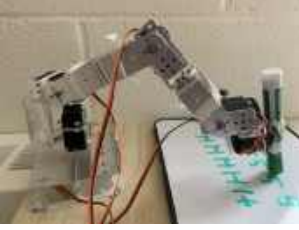

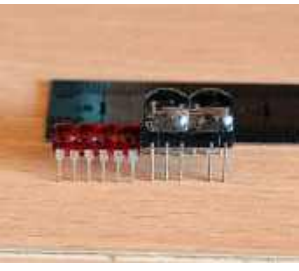

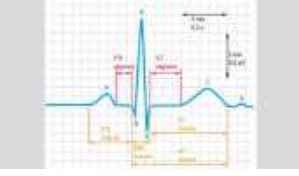





640.

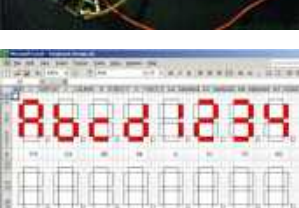

[Brushed Motor ESC using PIC12F675 microcontroller](#) Background There are a number of other projects that have been documented for brushed motor ESCs. The good starting point for other ESCs is this rcgroups thread. The information in the Microchip AN847 is also very useful. Most of these designs are very similar, the..... Listed under: [Motor Projects](#), [Projects](#)

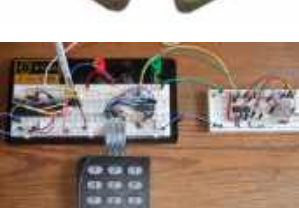
641.  [GTP USB PIC PROGRAMMER \(Open Source\) using PIC18F252](#) GTP USB PIC PROGRAMMER (Open Source) This work includes, GTP USB (not plus or lite) . The schematic, photos and PCB have been developed by PICMASTERS based on some valuable works done before. This programmer supports pic10F, 12F, 16C, 16F, 18F,24Cxx Eeprom. Unfortunately, it works..... Listed under: [Microcontroller Programmer Projects](#), [Projects](#)
642.  [Countdown Timer using PIC16F84 microcontroller](#) It's a kitchen timer. Use it to time spaghetti, or maybe an egg. It uses two PICs, one acts as a keyboard encoder, the other drives the display and supports the timer functions. You key in the desired time and press '#'. It's accurate to..... Listed under: [Clock and Timer Projects](#)
643.  [Grid Powered Battery Charger – The Plans using PIC16F676](#) You get a really good feeling when you plug in some lights and appliances and power them with your own electricity from the sun or wind. You get a really bad feeling when you run those items and the clouds come for days or weeks..... Listed under: [Battery Projects](#), [Projects](#)
644.  [Infra/radio remote control transmitter/receiver with PIC16F630](#) description This is a general purpose remote control project with using programmable PIC microcontrollers. Schematics are shown for using infrared (RF) or radio (RF) media. If you are not familiar with microcontroller programming, you can use fixed encoder and decoder integrated circuits instead. Well-known such..... Listed under: [Internet - Ethernet - LAN Projects](#), [Projects](#), [Radio Projects](#)
645.  [Writing Robot Arm](#) Introduction In this project, we built a writing machine using a 4-DOF robot arm. This robot arm is controlled by PIC32 and can write the 26 letters and ten numbers. Users can send instructions to the microcontroller through the serial interface to control the robot..... Listed under: [Robotics - Automation Projects](#)
646.  [NOPPP, the "No-Parts" PIC Programmer using PIC16F83](#) NOPPP is a simple programmer for PIC16C84, PIC16F83, and PIC16F84(A) microcontrollers. It attaches to the parallel port of a PC. Plans were published in Electronics Now Magazine, September, 1998, and are included in shorter form in the downloadable ZIP file. An article about this programmer..... Listed under: [Microcontroller Programmer Projects](#), [Projects](#)
647.  [Classic LED 7-Segment Displays using PIC16F887](#) Just recently I have been addicted to old LED displays as they are small and bright and I love the classic look. We can see them in vintage calculators and vintage led watches. However these displays consume significant amount of power, so they are not..... Listed under: [LED Projects](#), [Projects](#)
648.  [Capacitive Sensing Robot Arm](#) Introduction For our final project, we built a 2 axis robot arm with a capacitive sensor on the final member, which will allow the robot to detect a person near the robot. When there is an object detected, the arm will stop depending on the..... Listed under: [Robotics - Automation Projects](#)
649.  [PIC sound player \(PCM to PWM converter\) using PIC18F1320](#) Description This project makes a PIC microcontroller play audio PCM sounds using PWM modulation! Pulse-code modulation (PCM) is a digital representation of an analog signal where the magnitude of the signal is sampled regularly at uniform intervals, then quantized to a series of symbols in..... Listed under: [Projects](#), [Sound - Audio Projects](#)
650.  [Single-Supply Portable ECG Monitor](#) Introduction The aim of this project was to produce a portable ECG monitor that displays the ECG signal of an Einthoven triangle configuration of electrodes (3 leads). The motivation of this project comes from the pervasiveness of cardiac problems in the world, which cause the..... Listed under: [Other Projects](#)
651.  [A 12hr/24hr LED Clock with display control using PIC16F628A microcontroller](#) This LED clock may not be the easiest to build but surely it is the one with fewer parts that you can find, for that reason I call it "The ANP LED Clock". (ANP stands for Almost No Parts.) Using the micro controller PIC 16F84A..... Listed under: [Clock and Timer Projects](#), [LED Projects](#)



652.  [A simple display that uses the POV to display messages in the air using PIC12F629 microcontroller](#) A simple rotating display. Just spin and enjoy. While the "Air display" is rotating, it writes the message on the air. Because the "persistence of the vision", you will be able to read the message. Here is the circuit: Download the HEX file HERE Program the..... Listed under: [Other Projects](#), [Projects](#)
653.  [PicPOV – Persistence of Vision with a PIC18F1220](#) Description PicPOV is a project based on "persistence of vision". A PIC microcontroller blinks 8 LEDs on and off so that when waved through the air, a message appears to float in front of the viewer. Design and Implementation The design goals were: be simple..... Listed under: [LED Projects](#), [Projects](#)
654.  [How to getting started with microcontrollers projects using PIC12F629 microcontroller](#) Microcontrollers are, basically, a computer in a single chip. It contains memory, processor, I/O ports (I/O = Input/Output) and other peripherals. Can you believe a single chip does contain RAM, ROM, CPU, I/O Ports, timers and other gadgets? It only needs a keyboard and display..... Listed under: [Microcontroller Programmer Projects](#), [Projects](#)
655.  [PIC BALL MACHINE](#) Introduction Our ECE 4760 final project is PICBall: a PIC32-powered, old-school pinball machine! When trying to come up with a project that would encompass multiple parts of the class, we figured a more physical project (as opposed to virtual project) would be the most fitting..... Listed under: [Game - Entertainment Projects](#)
656.  [Candle Simulator using PIC12F675 microcontroller](#) Description The aim of this project is to create a credible simulation of the light of a candle. Candle light is usually warm and waves slowly with random oscillations caused by the air flowing in the surrounding environment. Using a random number generator to modulate..... Listed under: [Game - Entertainment Projects](#), [Home Automation Projects](#), [Projects](#)
657.  [7-Segment ASCII character Set A 127-character ASCII table for 7-segment LED or LCD displays using PIC16C84](#) I started to develop what I call my "next generation of microcontroller projects" (I have to find a name for that), so I needed a character set fully compatible with ASCII using only 7 segment displays. When I started to determine how many characters and..... Listed under: [LCD Projects](#), [LED Projects](#), [Projects](#)
658.  [Power Pic RGB with voltage control using PIC12F675](#) Power Pic RGB with voltage control is a circuit that generates many colors using a RGB LED and those colors can be changed using two independent voltages, supplied by some external device, in order to select the color (Hue) and its intensity (Value)! The idea originally came..... Listed under: [Other Projects](#), [Projects](#)
659.  [I2C keypad using PIC18F4550 microcontroller](#) I2C keypad This instructable explains how to interface with a 4x4 keypad over an I2C bus. I started this project because I wanted some plug and play input and output modules for easy and fast prototyping of my electronics projects (mostly with PIC microcontrollers). Of course you..... Listed under: [Interfacing\(USB - RS232 - I2c -ISP\) Projects](#), [Projects](#)
660.  [SmartCube DOLORS](#) Introduction DOLORS is a smart lamp that, paired with a Raspberry Pi, is capable of showing live weather information upon request, such as the temperature and sky condition. Additionally, it provides dynamic animation modes with vibrant colors and computer vision features. The main reason for..... Listed under: [LED Projects](#)
661.  [LED Binary Clock using PIC16F628A microcontroller](#) LED Binary Clock This is the second revision of my PIC based LED binary clock. The original version was the first PIC project I attempted, it used a PIC16F84A to do both the timekeeping and control the display matrix, unfortunately it didn't keep good enough..... Listed under: [Clock and Timer Projects](#), [LED Projects](#)
662.  [Parallel Port 3 Axis CNC Driver, Opto-Isolated, Unipolar Steppers using PIC16F876A microcontroller](#) Parallel Port 3 Axis CNC Driver, Opto-Isolated, Unipolar Steppers Controls 3 Unipolar Stepper Motors, for use with CNC Machines. Simple driver with automatic coil shutdown, to ensure efficient operation. Opto-isolated for protection of the P.C. Supports most parallel port based CNC software, such as KCAM..... Listed under: [Motor Projects](#), [Projects](#)
663.  [Twitter Watcher, the #twatch using PIC18F67J60 microcontroller](#) The #twatch scrolls the latest trending topics from Twitter on an LCD screen. It's a stand-alone network appliance that stays updated without a PC. It was awesome to watch #iranelection, Michael Jackson, and other historic events scroll by while we developed the #twatch. This Instructable..... Listed under: [LCD Projects](#), [Projects](#)
664. [Frequency Detector using PIC 12F683 Processor](#) Frequency Detector using PIC 12F683 Processor This project describes hardware and software I have developed which allows a small 8 bit PIC microprocessor to function as a single frequency detector or tone decoder. Such a circuit can be used to detect the presence of a..... Listed under: [Projects](#), [Sensor - Transducer - Detector Projects](#)

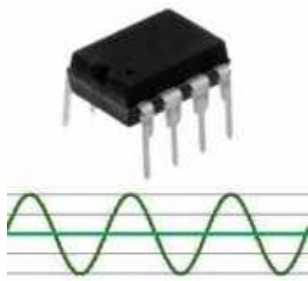

665. [TFTanks](#) Introduction TFTanks is a two player game in which small artillery tanks shoot projectile shells at each other across the TFT display screen. The game board consists of a randomly generated terrain landscape with sharp hills and valleys that players can destroy incrementally with their..... Listed under: [Game - Entertainment Projects](#)



666. [PWM Fan Controller using PIC12F675 microcontroller](#) PWM Fan Controller You can see the PWM Fan Controller project here. The heart of the PWM Fan Controller is a PIC 12F675 microcontroller. This microcontroller is reading the analog output of a LM35 temperature sensor using a ADC (analog to digital converter) . The..... Listed under: [Projects](#), [PWM Projects](#)



667. [Quick Key Adapter, 10 Button HID Keyboard using PIC18F14K50](#) Quick Key Adapter, 10 Button HID Keyboard This Instructable covers creating a USB connected Human Interface Device Keyboard that has 10 button inputs which are mapped to key combinations in the firmware. Key combinations can be quickly accessed without using the keyboard which may be inconvenient to use. Such as with a..... Listed under: [Other Projects](#), [Projects](#)



668. [Augmenting a Microcontroller using PIC16F886](#) Augmenting a Microcontroller Microcontrollers (MCUs) are fantastic little ICs that give an extra element of versatility to your electronics, robotics or other project. But they're really not much use on their own. To function, all MCUs need some sort of support components, and a board..... Listed under: [Other Projects](#), [Projects](#)



669. [Remote controlled led dice using PIC12F629 microcontroller](#) Remote controlled led dice I've always wanted to build an electronic led dice, but something different from what we see on the internet. Making it motion controlled... now that's new! I make remote controlled led dice please share with every one and like my projects..... Listed under: [Game - Entertainment Projects](#), [Home Automation Projects](#), [Internet - Ethernet - LAN Projects](#), [Projects](#)

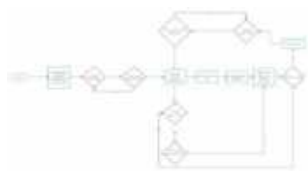

670. [Voice Controlled Dino Game](#) Introduction We have all been in a situation where we didn't have access to the internet and to pass time we started playing the Google Dino game. However, the game tends to get a little monotonous with all the key presses and the biggest fear..... Listed under: [Game - Entertainment Projects](#)



671. [ECG on your laptop using PIC16F876 microcontroller](#) ECG on your laptop! That's right! This Instructable shows you how to build a device that enables you to do an electrocardiogram on yourself, your family or your friends! All you need is intermediate-level knowledge on electronics, access to Ye' Ol' Electronics Shoppe (or online..... Listed under: [Medical - Health based Projects](#), [Projects](#)



672. [All pic programmer using 16F87X microcontroller](#) All pic programmer DO YOU HAVE A PIC PROGRAMMER? NO. DO YOU NEED A PROGRAMMER? NO. DO YOU NEED A PROGRAMMER?(WITH ANGRY VOICE) I MEANT YES THAN THIS PROGRAMMER IS MADE FOR YOU Step 1: MICROCONTROLLERS First something about microcontrollers: 1.Intro to microcontrollers 2 How..... Listed under: [Microcontroller Programmer Projects](#), [Projects](#)



673. [PIC18F Based 6 Channel DMX Transmitter](#) PIC18F Based 6 Channel DMX Transmitter Based on AN1076 - "Using a PIC® Microcontroller for DMX512 Communication". Modified and added to Microchip's code to use 6 Adc Channels for 6 channels of DMX data and the ability to offset its starting address via a 9-position DIP..... Listed under: [Projects](#), [Radio Projects](#)

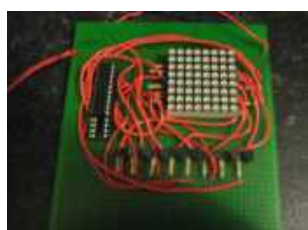









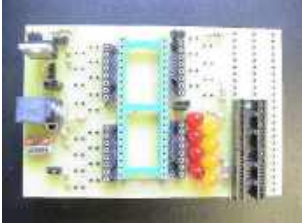
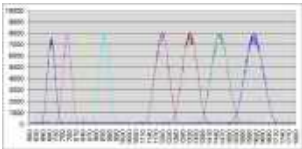

674. [8x8 LED matrix using PIC16F690 microcontroller](#) 8x8 LED matrix This instructable will show you how to make a 8x8 LED matrix in which you can control every single LED and create your own patterns as long as they only need 64 pixels to show them in one color.Update 25.09.10 I've added..... Listed under: [LED Projects](#)



675. [PIC32 Realtime Network Audio](#) Supported Browser For optimal experience with the equations, please use a browser that can render MathML, such as Firefox or Safari. Chromium-based browsers apparently do not support MathML. Introduction This project sends and receives low-latency audio over the network using the PIC32 microcontroller. In this..... Listed under: [Wireless Projects](#)



676. [MATLAB to PIC serial interface using PIC16F877 microcontroller](#) MATLAB to PIC serial interface some code to let MATLAB talk to a PIC16f877 via the serial port. This isn't that hard nor is it much code, but I spent a decent amount of time figuring it all out (starting from scratch), so I figured..... Listed under: [Interfacing\(USB - RS232 - I2c - ISP\) Projects, Projects](#)
- 
- 
677. [3x3x3 LED Cube using PIC16F690 microcontroller](#) 3x3x3 LED Cube Here is my 3x3x3 LED Cube project. It runs using a PIC16F690. Along with the brief explanation of how to make it, I have also included the .asm file for the PIC and a piece of software written in VB.NET that you..... Listed under: [Interfacing\(USB - RS232 - I2c - ISP\) Projects, LED Projects, Projects](#)
- 
- 
678. [PIC development/testing board using PIC16F877 microcontroller](#) PIC development/testing board Here's a PCB design for a bare bones PIC16F877 development board. All you need is a 4mhz crystal, two 22pf caps, one 4.7k resistor, and eight 470 ohm resistors, a 7805 regulator (not necessarily necessary, read below), and some LEDs (you don't..... Listed under: [Development Board - Kits Projects, Projects](#)
- 
- 
679. [DTMF Touch Tone Decoder Using Microchip PIC Microprocessor using PIC12F683](#) DTMF Touch Tone Decoder Using Microchip PIC Microprocessor This project contains the details of using a Microchip PIC12F683 8 bit microprocessor to detect DTMF tones. The completed program allows the processor to be programmed with a string of DTMF tones to detect. If the programmed..... Listed under: [Projects, Sensor - Transducer - Detector Projects, Sound - Audio Projects](#)
- 
- 
680. [Co-op Virtual Reality Maze: ECE 4760](#) Introduction Our project is a collaborative game in which two people work together on different devices to navigate a maze, one on the PIC and the other on a VR headset. Each player lacks crucial knowledge about the maze that would allow them to reach..... Listed under: [Game - Entertainment Projects](#)
- 
- 
681. [Control a Hobby Servo using PIC18F2455 microcontroller](#) Use a PIC Microcontroller to Control a Hobby Servo This instructable describes how to integrate hobby servos (the kind used in RC planes, cars, etc.) into your microcontroller projects. How Servos are Different from Regular Motors In a regular DC motor, the amount of torque..... Listed under: [Other Projects, Projects](#)
- 
- 
682. [How to make a Clap-Clap on / Clap-Clap Off switch circuit! using PIC10F222](#) How to make a Clap-Clap on / Clap-Clap Off switch circuit! Hi all! This instructable not only gives the reader the information needed to create a clap-clap on/clap clap off switching circuit, but the logic used to make a hardware-only clap-on, clap off circuit. More..... Listed under: [How To - DIY - Projects, Projects](#)
- 
- 
683. [DMX-512 RGB LED Wash Light Control Board using PIC16F688](#) DMX-512 RGB LED Wash Light Control Board A full featured driver board to control Red, Green, & Blue LEDs. When paired with the correct output board, it can control any arrangement of LEDs. Common Cathode, Common Anode, single color LEDs. From 1/8 watt LEDs to..... Listed under: [Game - Entertainment Projects, Home Automation Projects, Projects](#)
- 
- 
684. [Simple JDM PIC Programmer using PIC16f84A microcontroller](#) Simple JDM PIC Programmer I have built this project to burn my small PIC's This is a serial programmer works on the RS232 ( PC serial port ), known as JDM Programmer, thanks to the site <http://pic16f84.hit.bg/> which contains the schematic and the programmer software..... Listed under: [Other Projects, Projects](#)
- 
- 
685. [Karaoke Robot Judge](#) Introduction Karaoke Robot Judge is a karaoke machine with a robot Simon Cowell as a judge. For this project, we designed a karaoke machine on the PIC32 with a robot judge made of two servo motors. The user can choose one of three songs to..... Listed under: [Robotics - Automation Projects](#)
- 
- 
686. [Mood vase using PIC12F683 microcontroller](#) Intro: Mood vase I'm a fan of LEDs, lots of LEDs. So here's a slightly less crass way of using LEDs for decorative purposes. While this is by no means a neat and polished solution, and probably not the first of its kind, however the..... Listed under: [Home Automation Projects, LED Projects, Projects](#)
- 
- 
687. [48 Channel Mono / 16 Channel RGB LED Controller using PIC18F2550 microcontroller](#) 48 Channel Mono / 16 Channel RGB LED Controller The 48 Channel Mono/16 Channel RGB LED Controller by Chromation Systems can be used to independantly control 48 groups/channels (up to



120ma per group) of mono-color LEDs or 16 groups/channels of common anode RGB LEDs. It..... Listed under: [Interfacing\(USB - RS232 - I2c -ISP\) Projects](#), [LED Projects](#), [Projects](#)



688. [ECE 4760: Final Project Report](#) Introduction For our final project we made a digital vocoder, which could be accomplished over this semester's remote desktop environment. A vocoder is a synthesizer that generates sounds which are modulated by an input signal. It was originally designed to reduce the bandwidth of voice..... Listed under: [Robotics - Automation Projects](#)



689. [4760 Final Project: Spy Robot](#) Introduction For our final project, we created a spy robot: a robot that uses remote radar sensing to detect intruders. The physical system consisted of the servo setup we had from lab 4, a time-of-flight distance sensor (discussed in depth below), and the PIC32 microcontroller..... Listed under: [Robotics - Automation Projects](#)



690. [High Bandwidth Low Latency Communication with SPI Devices Controlled by PIC32](#) Introduction The purpose of this project is to implement high bandwidth low latency SPI communication between the PIC32 and a target module, which in this case is the OV7670 camera. The solution implemented in this project is derivative from a need to read data from the target..... Listed under: [Other Projects](#)



691. [Rubot](#) Introduction Almost everybody has used a rubik's cube puzzle before, whether they are picking up the cube for the first time, looking up the solution algorithms, or playing around with a different iteration. Many different kinds of rubik's puzzles have come out over the years,..... Listed under: [Robotics - Automation Projects](#)



692. [CAT BOT](#) Introduction Cat Bot, as its name suggests, is a cat robot that sees and follows around a cat toy, simulating actions of real cats. We have decided on this project since this system involves significant hardware and software elements, and constructing it required us to..... Listed under: [Robotics - Automation Projects](#)

693.  $v = v_0 + at$   
 $x = x_0 + v_0t + \frac{1}{2}at^2$

[LED Amusement Park](#) Overview Our project consists of a 2m DotStar LED strip with 120 individually addressable LEDs and seven accelerometers with the Big Board to depict three different rides that are typically found in an amusement park: the roller coaster, the drop tower, and the bouncer. We..... Listed under: [LED Projects](#)

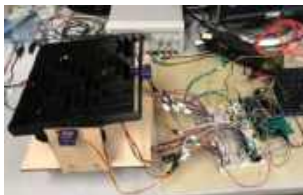

694. [ECE 4760 Glove Controlled Tilt Maze](#) Introduction Our project is a tilt maze game controlled by a glove worn by the user, which contains an accelerometer as well as sensors for each finger. The tilt of the maze is continuously updated in accordance with the position of the user's hand. The..... Listed under: [Game - Entertainment Projects](#)

695.  $z_{n+1} = (z_n)^2 + c$

[PIC-32 Julia Set Generator](#) Introduction The Julia Set, was used to generate fractal art on the TFT. The Julia Set can be described by , where z represents a point on the complex plane and c is a complex constant. In order to allow for user manipulation and interaction, a..... Listed under: [Other Projects](#)



696. [PIC32 DMA Graphics with Single Frame Buffer ECE 4760 Final Project](#) Introduction For our final project, we created two demonstrations utilizing direct memory access (DMA) in a graphics setting. Our original intent was to implement the video game DOOM on the PIC32, however that proved to be an undertaking too large given the time constraints of..... Listed under: [Other Projects](#)



697. [Boids, Predators, Joysticks, and Friends](#) Introduction For our final project, we made a video game in which the player controls a predator and gains points by eating boids. The video game ended up having three different modes and could be played by either one or two players. We enjoyed taking..... Listed under: [Game - Entertainment Projects](#)

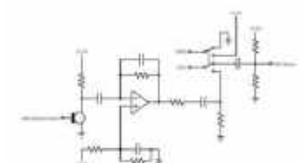

698. [Dancing Boids](#) Introduction and High-Level Design When we were brainstorming ideas, each one of us had different interests. Max wanted to do an audio-related project as he is working for McIntosh, a company that designs and manufactures handcrafted legendary home audio systems. Ben wanted to make something..... Listed under: [Other Projects](#)



699. [ECE 4760 FINAL PROJECT: REMOTE CONTROL TANK](#) For our project, we designed and built a remote control tank, which uses a modified motorized nerf gun as its firing mechanism, an ultrasonic sensor in order to sense objects in its surroundings, and a bluetooth module which allows the user to control the tanks..... Listed under: [Other Projects](#)

700. [One Pedal To Rule Them All](#) Introduction Audio effects are used in nearly every recorded and live song across genres, whether its reverb being added to a vocalist or noise being filtered from a drum track. When used with guitars, they're so ubiquitous that the interesting tones they create are often..... Listed under: [Other Projects](#)





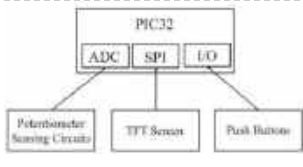

701.  [ECE 4760 Final Project: TKButtons](#) Introduction Fighting games are rising in popularity around the globe. However, a consistent barrier to new player entry has been the difficulty of the inputs. Rather than pressing a single button for attacks and moves, fighting games often require complex frame-perfect combinations of buttons to..... Listed under: [Game - Entertainment Projects](#)

702.  [MINIATURE ARCADE GAME COLLECTION](#) INTRODUCTIONBOIDS Our project leverages two potentiometers to create an "etch-a-sketch" type interactive device and arcade game collection. We wanted to create a fun game that uses much of what we learned previously in the course, including flocking simulation, hardware input through potentiometers, optimization, and graphic..... Listed under: [Game - Entertainment Projects](#)

703.  [Whack-a-Button](#) Introduction Whac-A-Mole (Mogura Taiji) is a popular carnival game that originated from Japan; it involves the player whacking a mole that can appear out of one of five possible holes. Over the years, as the game grew in popularity internationally, many variations of the game..... Listed under: [Game - Entertainment Projects](#)

704.  [SPATIAL AUDIOMAP](#) Introduction Our project is a spatial audio map of Collegetown that allows the user to use a joystick to virtually travel around the Collegetown crossing area and hear surrounding, directional sound. [embed]https://youtu.be/VflrSeTrtwUJ/embed] Our project takes inspiration from Street View, an interactive technology featured in Google..... Listed under: [Sound - Audio Projects](#)

705.  [Two-Player Boids Game With Laser Pointer Controllers](#) Introduction We have created a game based on the principles of the boids algorithm introduced in Lab 2. The game involves two players standing in front of a projector screen full of boids, each player taking on the role of a predator and using a..... Listed under: [Game - Entertainment Projects](#)

706.  [Embedded Instruction Kit](#) The purpose of this project was to create an electronics kit for teaching entry level programming of embedded systems. The kit includes a development board, external hardware modules, software, and teaching materials. The hardware modules consist of a LCD display, Keypad and various user I/O..... Listed under: [Other Projects](#)

707.  [CARLETON PROJECTS](#) This is the Carleton Weather Station, at least the computer end of it. The data acquisition system is to the left and the web server is the Mac computer. It is located in Olin 206. This is the Carleton Weather Station's data acquisition system. This..... Listed under: [Temperature Measurement Projects](#)

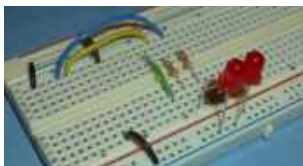
708.  [CSCI 255 — Pin I/O on the PIC](#) Getting ready You'll need the follow hardware for this lab. Breadboard — large or medium Microstick Two resistors — 330 to 470 Ω Two LED's Two push-down switches A small amount of wire Microchip references PIC24HJ32GP302/304, PIC24HJ64GPX02/X04 and PIC24HJ128GPX02/X04 datasheet PIC24H Family Reference Manual Pin..... Listed under: [Other Projects](#)

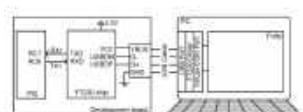
709.  [EENG 383](#) Requirements Working in teams of two, read through the following lab activity and perform all the actions prescribed. You do not need to document bullet items. Make a record of your response to numbered items and turn them in a single copy as your teams..... Listed under: [Other Projects](#)

710.  [CSCI 255 — Introduction to MIPS32 Assembly](#) In this lab we are going to use MPLAB® X IDE and its associate XC32 compiler to write and debug a PIC32 assembler program. The MPLAB X software is NetBeans based and will run under Linux, Mac and Windows. You can download your own copy of MPLAB X..... Listed under: [Other Projects](#)

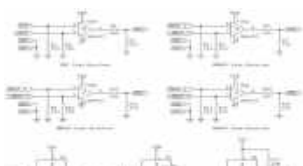
711.  [Assembly Instructions for the μMD1 using the Digilent chipKIT DP32](#) Assembly using the chipKIT DP32 Board Unless you dug up a dusty chipKIT DP32 in the back of one of your electronics junk drawers (or I unloaded the last one I have), what's in here is mostly irrelevant. Go (back) to Assembly using SG-μMD1. Electronic Parts..... Listed under: [Sensor - Transducer - Detector Projects](#)

712. [Serial communication with Matlab](#) Overview Matlab has a "serial" function that allows it to communicate through a serial port. This project is to establish serial port connection with the PIC microcontroller and demonstrate bidirectional communication between the PIC and a Matlab program. For demonstration purposes, the PIC will send..... Listed under: [LED Projects](#)



713. [Setting up the PIC Microcontroller](#) The following programs are examples that I use for teaching the programming of 8-bit PIC microcontrollers. A good reference is the book "Designing Embedded Systems with PIC microcontrollers: Principles and Applications" by Tim Wilmshurst. The datasheet for the PIC is also a good reference for..... Listed under: [Microcontroller Programmer Projects](#)

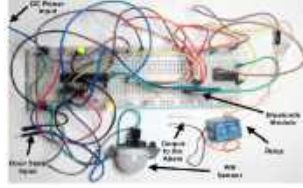

714. [Lab 10: Programming the PIC Microcontroller](#) Introduction By now, you should be familiar with the workings of the 68HC12 and how it can be used to perform computations and interface to peripheral devices. Although the 68HC12 is a popular microcontroller used in many industry, research, and hobbyist projects, it is important to learn about..... Listed under: [Microcontroller Programmer Projects](#)



715. [Building a PIC18C and System-on-a-Chip in an FPGA](#) Description The goal of the PIC18C project is to design, develop a synthesizable VHDL model, verify it using test programs, and implement a core of the Microchip PIC18C microcontroller. The microcontroller core is fully compatible with the PIC18 series allowing program development using high-level programming..... Listed under: [Other Projects](#)



716. [The 5 minute intro to using the PIC16F84A microcontroller](#) News Aug. 13, 2009: There was a problem with the C code I posted initially, which I fixed. Get a new version from below if you tried the code and it didn't work. Facts data sheet <http://ww1.microchip.com/downloads/en/devicedoc/35007b.pdf> pins: Writing and compiling code for the 16F84A The thing..... Listed under: [Microcontroller Programmer Projects](#)

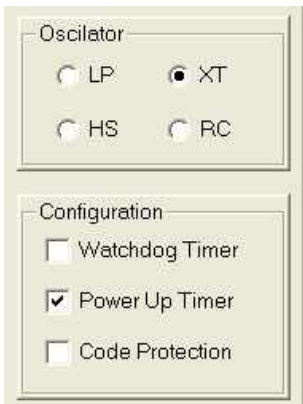

717. [Ethernet Controller and Microcontroller Research](#) The independent studies research with Dr. Karl Gugel during the fall semester of 2010 involved experimenting with built-in and separate Ethernet controller devices. The goal of this project was to determine the necessary components needed to be able to interface the various ethernet controllers with..... Listed under: [Microcontroller Programmer Projects](#)



718. [Diversified Projects in Microcontroller Class Enhances Undergraduates' Learning and Research](#) Abstract Understanding the use of microcontrollers is fundamental in both Electrical and Computer Engineering undergraduate programs. Our school replaced our microprocessor class with microcontroller class in year 2010 due to the fast growing popularity of microcontrollers. In the first two years of offering this class, a more traditional..... Listed under: [Microcontroller Programmer Projects](#)



719. [Development of a MATLAB-based Graphical User Interface Environment for PIC Microcontroller Projects](#) 2.1. Introduction Peripheral Interface Controllers (PICs), developed and marketed by Microchip Technology, Inc. [35], are inexpensive microcontroller units that include a central processing unit and peripherals such as memory, timers, and input/output (I/O) functions on an integrated circuit (IC). There are more than 100 varieties of..... Listed under: [Development Board - Kits Projects](#)

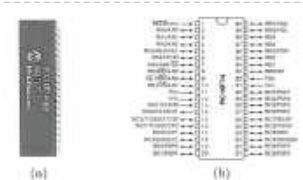

720. [ECE383: Microcomputers – Lab 5 C and PIC24 Assembly Language Programming](#) Introduction This lab introduces basic C language programs and equivalent PIC24 assembly language programs. The tasks in this lab are:• Implement programming tasks using the C language.• Implement equivalent programs using the PIC24 assembly language. This lab requires you to capture portions of the screen. The lab computers..... Listed under: [Microcontroller Programmer Projects](#)





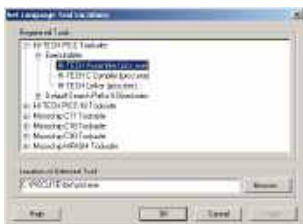



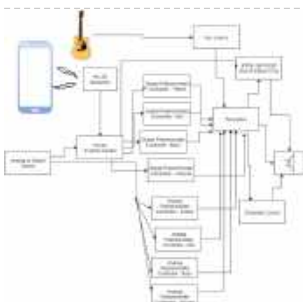

721. [MPLAB IDE + HI-TECH PICC LITE Compiler- Installation and Setup](#) Downloads The downloads below are freely available and downloadable from Microchip and Hi-Tech websites. The MPLAB IDE and HI-TECH PIC C LITE Compiler downloads are provided here for convenience. For system requirements, further details, updates, or patches consult the appropriate webpages. Microchip MPLAB IDE 6.20 mp620full.zip HI-TECH PICC LITE v8.01..... Listed under: [Other Projects](#)

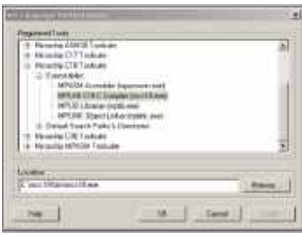
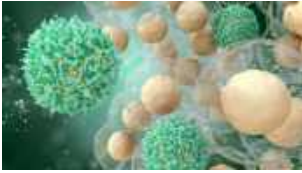

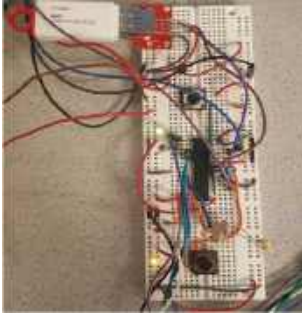
722. [Bluetooth-Controlled Guitar FX Amplifier](#) As part of our final project for ECE 4760: Digital Systems Design Using Microcontrollers, we built a guitar amplifier with remote distortion and digital effects capabilities controlled from a smartphone via bluetooth. Musicians often need to modify the configuration of their amplifiers when performing in..... Listed under: [Bluetooth Projects](#)



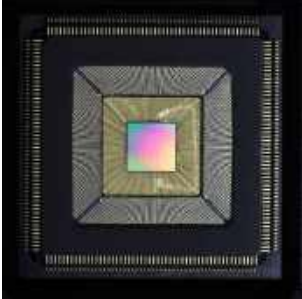

723.  [The Hitchhiker's Guide to C Programming on the PIC](#) This guide introduces C programming with emphasis on the PIC C compiler. It assumes familiarity with another high-level programming language such as Java. Parts of this tutorial are adapted from Nathaniel Pinckney's C Microtoys tutorial. More information is available in the Microchip MPLAB C18 C Compiler manuals. Using..... Listed under: [Microcontroller Programmer Projects](#)
- 
724.  [Microchip Provides New Understanding of How T Cells React to Infections and Treatments](#) Fast Facts: NYU Abu Dhabi researchers have developed a microchip that can isolate T cells, in a systematic and precise manner. T cells are a type of white blood cell that is important to the immune system and is at the core of immunity, the..... Listed under: [Medical - Health based Projects](#)
- 
725.  [BYU researchers create world's most power-efficient high-speed ADC microchip](#) To meet soaring demand for lightning-quick mobile technology, each year tech giants create faster, more powerful devices with longer-lasting battery power than previous models. A major reason companies like Apple and Samsung can miraculously pull this off year after year is because engineering wizards around..... Listed under: [power - energy\\_projects](#)
- 
726.  [MPLAB Tutorial](#) What you will learn 1.1. How to create a project using MPLAB. 1.2. How to link the files necessary to build a hex file. 1.3. How to simulate operation of the file. 1.4. How to emulate the microcontroller using MPLAB ICE 2000. 1.5. How to program the..... Listed under: [Other Projects](#)
- 
727.  [Using the PIC32MX250F128B as a USB Host to Interface With Mass Storage Devices](#) Introduction This project was done in order to allow a PIC32MX250F128B to act as a host to a USB mass storage device. This would allow for a USB flash drive to be connected to the PIC32 which would allow for data to be read from or stored..... Listed under: [Interfacing\(USB - RS232 - I2c -ISP\) Projects](#)
- 
728.  [A Tiny Microchip Wins Big!](#) Inspired by the smart technology of a hand-held game controller, Dr. Joshua Broder of Duke University walked away the ultimate winner in the inaugural Point-of-Care Ultrasound (POCUS) Research Challenge offered by the Emergency Medicine Foundation (EMF) and GE Healthcare (GE). In a first-of-its-kind research partnership, EMF and GE launched the..... Listed under: [Medical - Health based Projects](#)
- 
729.  [Programming HID Bootloader on PIC32](#) The bootloader is used to install programs on the PIC32 without using an external programmer like an ICD2 and does not require any drivers on the computer. The PC software for the bootloader for the PIC has already been installed with the Microchip Applications Library. Software..... Listed under: [Microcontroller Programmer Projects](#)
- 
730.  [The Microchipoptera Project](#) Motivation: The echolocating bat is a wonderful animal that is unique in so many different ways: it is the only truly flying mammal, it can use air-coupled sonar to navigate in complete darkness while flying, it can allow its body temperature to drop to..... Listed under: [Temperature Measurement Projects](#)
- 
731.  [Microchips' optical future](#) As the United States seeks to reinvigorate its job market and move past economic recession, MIT News examines manufacturing's role in the country's economic future through this series on work at the Institute around manufacturing. Computer chips are one area where the United States still enjoys a..... Listed under: [Other Projects](#)
- 
732.  [New microchip demonstrates efficiency and scalable design](#) Princeton University researchers have developed a new computer chip that promises to boost the performance of data centers that lie at the core of numerous online services such as email and social media. The chip — called "Piton" after the metal spikes driven by rock climbers into..... Listed under: [chipKIT Projects](#)
- 
733.  [ECT358L – Microprocessors II Laboratory Setting up and Using the Microchip MPLAB IDE](#) MPLAB Installation Download the MPLAB 8.33 application (MPLAB\_IDE\_8\_33.zip) from the course website under Lab 1 Extract the MPLAB\_IDE\_8\_33 folder and select the "Install\_MPLAB\_8\_33.exe" file to start the installation process as shown in Figure 1. Figure 1: Starting dialog for MPLAB install Do a complete install of all..... Listed under: [Other Projects](#)
- 
734. [New Software Promises to Radically Simplify Chip Design](#) In 1975, Intel founder Gordon Moore predicted that the number of transistors on a single microchip would double every two years. He was right: silicon wafers that in the 1970s held just a few thousand transistors now routinely

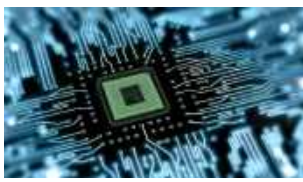

contain tens of billions of components. That..... Listed under: [Other Projects](#)

735.



[Using Microchip's MPLAB X IDE and Programming the PIC18F](#) Overview This guide provides a step-by-step guide on how to use the MPLAB X software by Microchip to set up a project, write code and generate a programming file for the PIC microcontroller. It then explains how to program the PIC (in this case a PIC18F25K22) using..... Listed under: [Microcontroller Programmer Projects](#)

736.



[Examining the environmental impact of computation and the future of green computing](#) when you think about your carbon footprint, what comes to mind? Driving and flying, probably. Perhaps home energy consumption or those daily Amazon deliveries. But what about watching Netflix or having Zoom meetings? Ever thought about the carbon footprint of the silicon chips inside your..... Listed under: [Development Board - Kits Projects](#)

737.



[What Managers Can Learn From the Microchip Industry](#) Tuck professor Constance Helfat proposes a new theory of firm integration based on the costs of technological innovation When Jack Kilby invented the integrated circuit—now known as a microchip—at Texas Instruments in the late 1950s, he unwittingly launched a multi-trillion-dollar industry that facilitated the information..... Listed under: [chipKIT Projects](#)

738.



[Novel Tandon-designed microchip will allow data to be processed without being decrypted](#) A research team at the NYU Center for Cyber Security (CCS) at NYU Tandon are participating in a major initiative in collaboration with data security company Duality — supported by a \$14 million grant from the Defense Advanced Research Projects Agency (DARPA) — to design a revolutionary..... Listed under: [Other Projects](#)

739.

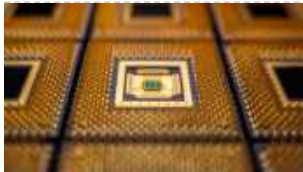

[Rethinking microchips' design pushes computing to the edge](#) Responding to artificial intelligence's exploding demands on computer networks, Princeton University researchers in recent years have radically increased the speed and slashed the energy use of specialized AI systems. Now, the researchers have moved their innovation closer to widespread use by creating co-designed hardware and..... Listed under: [Other Projects](#)

740.



[NEW MICROCHIP IMPROVES FUTURE OF SELF-POWERED WEARABLE TECHNOLOGY](#) Energy from your body heat and motion could fuel the future of preventative health care. Researchers at the University of Virginia are developing a low-power microchip that can support on-body, real-time health monitoring. By harvesting all its needed energy from sources like body heat, motion..... Listed under: [chipKIT Projects](#)

741.



[Packing power into smaller spaces](#) Researchers create new polymer-based electrical insulation for smaller microchips From slimmer laptops to smaller smartphones, all of our most-used devices rely on increasingly smaller microchips. But, in recent years, researchers have seemingly hit the limit on how far these chips can shrink. One of the..... Listed under: [Phone Projects](#)

742.



[Easy Cheap 16F84 POV Message – AirText](#) This is a post of LEDs project. The project is called POV (Persistence Of Vision). If you are not familiar with this concept, it works as an LED matrix display. The difference is that POV display consists of one column of LEDs only and is mechanically scanned through space..... Listed under: [Other Projects](#)

743.



[AVR High Voltage Programming \(Fuses Rescue\)](#) Half a year ago I restarted one of my old passions - electronics. I've studied electronics in college but that happened during the Middle Age (20yrs ago). While I was expecting this huge leap in schematics and what a hobbyist can do nowadays, I still..... Listed under: [Other Projects](#)

744.



[ESP32 With RFID: Access Control](#) How about a method of automatic identification through radio signals that can bring you security and control the access of people to a certain location? This is possible through radio frequency identification or RFID from the English Radio Frequency Identification. And it is the assembly..... Listed under: [Radio Projects](#)

745.



[The 2\\$ USB Pic Programmer & Serial Cable](#) This programmer is intended for people who need a microchip pic programmer to flash at hex file onto a micro controller, but seldom do so and find investing in a pic kit of some sort too expensive. The programming process will take a long time,..... Listed under: [Interfacing\(USB - RS232 - I2c -ISP\) Projects](#)

746.



[INCUBATOR TEMPERATURE REGULATOR](#) The Incubator Temperature Regulator is made on a breadboard to demonstrate how to program and set the temperature of the regulator. It uses an LM35 temperature sensor, a serial LCD made with a PIC16F628A microcontroller and an Arduino Nano. The low & high setpoint is..... Listed under: [Temperature Measurement Projects](#)

747.

[How to Build a Self Navigating Robot](#) This is a detailed tutorial on how to realize a robot starting from scratch, and giving it the ability to navigate autonomously in an unknown environment. All the typical arguments involved with robotics will be





covered: mechanics , electronics and programming . The whole robot is designed to be made by..... Listed under: [Robotics - Automation Projects](#)

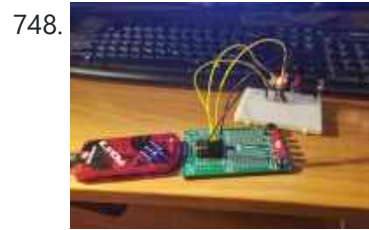

748. [How to Get an Analog Input on a PIC Microcontroller](#) This guide hopefully will show you how to write C code that will allow you to read in an analog input (AI) value to your PIC microcontroller. I am using a PICkit 3 programmer with a PICkit 2 18-pin demo board. The microcontroller is a..... Listed under: [Microcontroller Programmer Projects](#)



749. [8 Channel Programmable Timer](#) Introduction I have been using Microchip's PIC range of microcontroller for my projects since 1993, and have done all my programming in assembler language, using the Microchip MPLab IDE. My projects ranged from simple traffic lights and flashing LEDs, to USB joystick interfaces for R/C..... Listed under: [Microcontroller Programmer Projects](#)



750. [MicroSimon](#) This project shows how to create an MB Electronics Simon game clone using an 8-pin PIC12F683 microcontroller. The game includes a full emulation of the original Simon 'game 1' and the ability to select from 4 skill levels which control the number of colours you..... Listed under: [Game - Entertainment Projects](#)

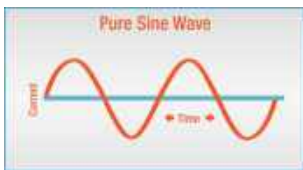

751. [Pure Sinewave Inverter Using Pic16f72 Without Center Tap Transformer and Without HV Transformer](#) finally the most reliable and awaited pure sine wave inverter,it's here for all members.(don't hesitate to contact me @ hisham2630@gmail.com. features: INVERTER O/P VOLT : 230V (+2%)INV. O/P FREQ : 50Hz INV. O/P WAVEFORM : SINE WAVE HARMONIC DISTORTION : <3% CREST FACTOR : >4:1..... Listed under: [Other Projects](#)



752. [Generate PWM Wave With PIC Microcontroller](#) WHAT IS PWM? PWM STANDS FOR PULSE WIDTH MODULATION is a technique by which width of the pulse is varied. To understand this concept clearly consider a clock pulse or any square wave signal it has 50% duty cycle that means Ton and Toff period is same,..... Listed under: [Other Projects](#)



753. [RF MODULE INTERFACE TO 8051 MICROCONTROLLER](#) This instructable covers the interface of 8051 microcontroller with the cheap 315/433MHz RF module. This comes in handy in different kinds of wireless connectivity projects like Robotics, Wireless Level sensors, etc. The sensor is really cheap, typically about \$5. I have implemented this module with..... Listed under: [Microcontroller Programmer Projects](#)



754. [Interrupt Routine in Assembly Language Using 8-bit PIC](#) Hello reader. This is one of the most basic and important instruction ever made for Microcontrollers low level programming. Talking about the external interrupts routine in Assembly Language for PIC. Today I'll present a blueprint for the development of an experimental basic circuit and show..... Listed under: [Other Projects](#)



755. [USB to Serial TTL](#) For some of my PIC projects I need a serial (RS232) interface to print some messages on the screen of my computer. I still have a desktop computer that has one RS232 interface but nowadays most computers have a USB interface instead. You can buy..... Listed under: [Interfacing\(USB - RS232 - I2c -ISP\) Projects](#)



756. [USING Xtreme Burner for AVR Microcontroller Programming](#) All you AVR user fraternity out there, and those just entering the stream, Some of you started with PIC microcontrollers and some started with ATMEL AVRs, this is written for you ! So you bought a USBASP because its cheap and effective to flash the..... Listed under: [Microcontroller Programmer Projects](#)



757. [PLC Con EI C16F877A](#) The present project called PLC with Pic C16F877A is based on the operation of a PLC, today we can see these systems in industries, mining, etc. It is used to program an industrial PLC, it is the ladder language or (LADDER). The project has the..... Listed under: [Other Projects](#)

758. [Build a Pulse Analyzer](#) A Message from me: Hello! Thank you for reading my first instructables on building a pulse analyzer using PIC24f in Assembly language. I have almost completed the project, but not yet finished writing this instructables as I want it to be as comprehensive as possible..... Listed under: [Other Projects](#)

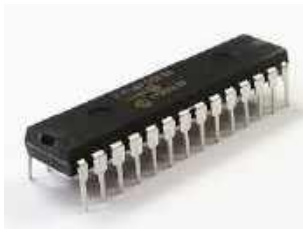

759.



[R/C Controlled Switch for Drones](#) Although there are MANY good circuits available on the internet for similar projects, I had a dedicated problem to solve. Most of the circuits available switches their outputs on at mid stick position (50%). My drones all use six channels (Throttle, Aileron, Rudder, Elevator, GPS..... Listed under: [Wireless Projects](#)

760.



[Beginners Guide to Debugging in MPLABX Using ChipKIT PRO MX7 by DIGILENT](#) This Instructable is a beginners guide to debugging code programed in the MPLAB X IDE v2.0. The steps covered are common application's of the debugger software and problems I encountered as a beginner user and a inexperienced programmer. The content will be useful to programmers..... Listed under: [Other Projects](#)

761.



[PianoPIC](#) This little project is an example of a simple audio application using a PIC micro-controller. We decided to use the PIC18F4550 micro-controller for memory purposes. Using only digital inputs and outputs, we developed this simple piano/synthesizer with an 8 bit kind of style: Inputs from b1..... Listed under: [Other Projects](#)

762.

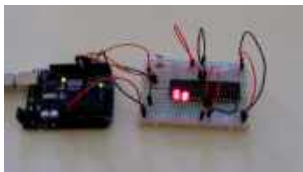

[How to Program a PIC 18F2550 or 18f4550 With Arduino UNO](#) here is our our first tutorial on Instructable so be indulgent. This tutorial shows the method of using an Arduino UNO board as a PIC microcontroller programmer. This method has been tested with PIC 18F2550 and 18f4550 but can be used to program the following..... Listed under: [Microcontroller Programmer Projects](#)

763.



[Easy PIC Micro State Transition Interrupt Code](#) A PICBasic program which interrupts the PIC when a high/low transition occurs on pin PortB.0 The code is available for download as a .rar or just copy and paste it from here. I got the starting code from the microengineering website:<http://www.melabs.com/resources/samples.htm> but I added the..... Listed under: [Other Projects](#)

764.

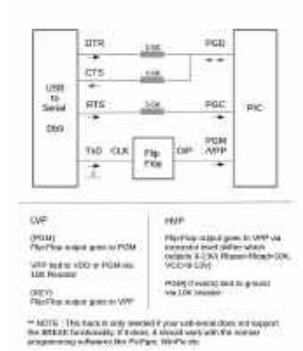

[PIC Programmer Using USB-Serial Converter for 18F4550](#) Note : This hack is only needed if your usb-serial does not support the BREAK functionality. Else, it may work with as it is, with the usual programming software like PicPgm, WinPic etc. Usually the DIY programmers like JDM do not work for usb-serial converters..... Listed under: [Microcontroller Programmer Projects](#)

765.



[PIC Microcontroller Development Board System](#) This project is for the design and use of a PIC development tool which is flexible to suit a wide range of PIC based electronic projects. It is often easier to develop microcontroller projects with the use of development tools; which allow user based code..... Listed under: [Development Board - Kits Projects](#)

766.



[GSM/GPS VEHICLE GEOGRAPHICAL TRACKER](#) The project is based on a Gsm/Gps/Gprs. Its main function is to detect a illegal entry and communicate its own geographical position using, on the choice, the cellular phone reference system or the GPS. I use the recent product by SIMCOM - SIM908 which operate..... Listed under: [Wireless Projects](#)

767.







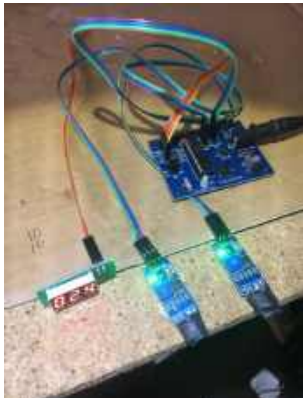





[AVR Mini Board With Additional Boards](#) Somewhat similar to PIC 12f675 mini protoboard, but extended and with additional boards.Using attiny2313. Step 1: Scheme Let us first start with a scheme. The scheme is pretty obvious since it only connects attiny2313 with the pins and the only additional elements are resistors and..... Listed under: [Development Board - Kits Projects](#)

768.













[Model Train Speedometer V2](#) This project started off being based on an Arduino UNO. And it worded ok, I found the software published on the internet. For example <https://forum.arduino.cc/t/model-railroad-speedome...> This is actually version 2 using a smaller PCB and PIC chip. It works in exactly the same way as V1..... Listed under: [Metering - Instrument Projects](#)



769.  [7 Segment Pov 16F84](#) This is a post about the POV ( Persistence of Vision ) Display that uses one 7 Segment display. In short, I made this little project as a proof of concept of something I 've always noticed in many electronic devices those used 7 segment display. Devices like 7..... Listed under: [Other Projects](#)
- 
770.  [8 Bit Serial Digital to Analog \(5v Range\) Converter for Microcontrollers \(when TTL and Resistors Is All You've Got\)](#) So I needed a DAC (digital to analog converter) to use with my pic12F675 , and for those of you who have never heard of this little fella, it's an 8 pin microcontroller from Microchip that has only 6 I/O pins... This is a very..... Listed under: [Other Projects](#)
- 
771.  [PIC MCU and Python Serial Communication](#) Hello, guys! In this project I will try to explain my experiments on PIC MCU and Python serial communication. Over the internet, there are many tutorials and videos on how to communicate with PIC MCU over virtual terminal which is very useful. However, in my..... Listed under: [Other Projects](#)
- 
772.  [Led Blinking by Basic Language Using PIC16f877A](#) PIC16F877A Pin out & Descriptions There are 5 ports that provide parallel I/O Interfaces to outside world PORTA, PORTB, PORTC, PORTD, PORTE Each port provides 8 bidirectional digital I/O lines which are connected to PIC16F877A pins provided that alternate functions are not selected on that..... Listed under: [LED Projects](#)
- 
773.  [PURE SINE WAVE INVERTER WITH LED AND LCD](#) The inverter PCB is easy to assemble by following the label of the components to be inserted. The choice of the voltage to be used to power the inverter ranging from 12v to 48v depends on kva you are designing. for any setup, a 12v..... Listed under: [LCD Projects](#)
- 
774.  [Wireless Radio Frequency Module Using PIC Microcontroller.](#) It's a Microcontroller Based DIY Electronics Project. Named Wireless RF Module Using PIC Microcontroller. The RF module is a small electronic circuit used to transmit, receive, or transceive radio waves on one of a number of carrier frequencies. RF modules are widely used in consumer..... Listed under: [Wireless Projects](#)
- 
775.  [RGB LED Love Heart](#) This project creates a RGB LED lit love heart which is controlled by a PIC12F683 microcontroller. I designed the project as a gift for my wife on our 15th wedding anniversary (since she puts up with my addiction to electronics I thought she deserved something..... Listed under: [LED Projects](#)
- 
776.  [Meet the Parallax Propeller QuickStart Board](#) The Propeller processor chip is the most unique micro-controller on the market today. It's not just a single microprocessor, but EIGHT independent processors that shareresources like memory and I/O pins. And it can do some pretty amazing things thatthe rest of the microcontrollers like the Arduino..... Listed under: [Other Projects](#)
- 
777.  [Build a PDK \(Pocket Development Kit\)](#) It's nice to be able to work on projects while on the road. This kit lets you carry an entire dev kit in your pocket. This instructable will show you how to build any of several different types of development kits (dev kit) which will..... Listed under: [Development Board - Kits Projects](#)
- 
778.  [SINE WAVE INVERTER USING PIC MICROCONTROLLER](#) Introduction: In this project we discuss about "Pure Sine Wave Inverter". This is a basic need of our daily life because normally used inverter in our daily life this is square wave output. We make pure sine wave inverter for better future and save our..... Listed under: [Microcontroller Programmer Projects](#)
- 
779.  [Low Cost 1 Wire Lcd for 8 Pin Micro Controllers \[romanblack Shift1 System.\]](#) Shift1 System is a cheap and simple way to get lots of digital output pins and only needs 1 PIC pin to drive it. Step 1: How It Works - the Simple System Normally, serial-in parallel-out shift register ICs can be set up for 2 pin..... Listed under: [LCD Projects](#)
- 
780. [Pic Programmer USB](#) Well I'm bringing home pic programmer, inexpensive clone pickit2 and support products microchip pic 18F2550 is used, this controller has an output voltage of 3.3v and 5v for different pic's that use different voltages. Well this programmer is built because here in my country Mexico,..... Listed under: [Microcontroller Programmer Projects](#)





792.  [YEAAAUGH, WHHAT? OKKKAY! Lil Jon Easy Button](#) Ever wish the Staples Easy Button (R) could say something better than the mundane "That was easy."? How about a Lil Jon button? YEAAAUGH, OKKKAY! LET'S GO! <https://youtu.be/483wn53HDsE> Attachments liljon\_board.zipDownloadliljon\_project.zipDownload Step 1: What You Will Need (and Where to Get It): NOTE: You will need ..... Listed under: [Other Projects](#)
793.  [Realtime OS / LCD on \\$12 Discovery Board](#) One day I had a college professor getting ready to teach us students a powerful mathematical trick in EE101 - mesh circuit analysis I think. Before he got started he said, "Today, my students, I give you a BIG gun." It got our attention and..... Listed under: [LCD Projects](#)
794.  [Automated Power Tool Charger](#) Electric power tools changed the way most of us work around the house. Simple and quick, as no extension cords are needed. But they do come with some effort. I still have some power tools that are powered by old Ni-Cad or Ni-Mh batteries. They..... Listed under: [Other Projects](#)
795.  [Installing MPLAB X for ChipKIT Products](#) Many of you who follow my For Cheap Robots series are familiar with how to use MPIDE with chipKIT products. You may even be familiar with how to use the Arduino IDE with these boards. So far, however, I have not used MPLAB X very much. MPLAB..... Listed under: [Robotics - Automation Projects](#)
796.  [ESP32 ADXL345 DATALOGGER WITH GPS EXT RAM EXT RTC](#) For those of you out there playing with the Wemos 32 LOLIN board I thought i would start to document some findings of mine so far. <https://youtu.be/vkNH4vC1B7Y> Current project is to interface to an ADXL345 accelerometer and as the photo shows above i have successfully..... Listed under: [Wireless Projects](#)
797.  [PIC16F877 Multimeter](#) PICMETER Introduction This PICMETER project has grown into a useful and reliable tool for any electronics enthusiast. It runs on a PIC16F877 / 877A micro controller. It is a PIC development system It is 19-function multi-meter (voltmeter, frequency meter, signal generator, thermometer...) It is a..... Listed under: [Metering - Instrument Projects](#)
798.  [Mini Sumo](#) Today we will explain how to perform the design, operation, and construction of a sumo robot, a robot is considered an automatic programmed machine to accomplish a certain task. In this opportunity, our robot will have the task of facing another robot on the battlefield..... Listed under: [Robotics - Automation Projects](#)
799.  [High Intensity Interval Training \(HIIT\) Timer](#) Where I live, the cold months seem to go on forever so I have to find some way to exercise that keeps me indoors. I could afford to go to a gym but it takes too much time, I'd have to show off my old..... Listed under: [Blog, Clock and Timer Projects](#)
800.  [Idea: a Simple PIC Development Board](#) A simple development board seems like a fun project. I'm recording my ideas here, and hope to get some input from other members of the 'uC (or anyone else).To avoid feature creep, I think several levels of dev-board would be a good idea. This page..... Listed under: [Development Board - Kits Projects](#)
801.  [PIC18F2550 Very Simple Penguin](#) Pinguino is a Bootloader and SSoftware that allows you to load and reload programs within a microcontroller, this time we are going to develop a Pinguino with the most economical and simple parts that we can find. You can install the X4 version of the..... Listed under: [Microcontroller Programmer Projects](#)
802. [BOOTLOADER WITH PIC18F2550](#) This is a small board which use the well know Pic18F2550, this microcontroller is easy to find in the electronic stores and most of the electronics hobbyist have one of them in their stock. So in this opportunit We are going to build a development..... Listed under: [Interfacing\(USB - RS232 - I2c -ISP\) Projects](#)



803. [Pocket Sized Morse Code Flasher](#) A microcontroller is a small computer which fits on a single chip. Like other computers, the microcontroller follows a sequence of instructions, one at a time, to carry out a program. With the help of a microcontroller we are going to make a morse code..... Listed under: [Other Projects](#)



804. [Homemade MPC Style MIDI Controller](#) 1.0 INTRODUCTION I decided to build and design a midi controller which is used to send commands to a computer running a DAW(digital audio workstation) to control different parameters within it. The DAW I used is called Ableton Live. There are 16 button pads and..... Listed under: [LCD Projects](#)



805. [How to Make a Universal Usb Pic Programmer PICKit 2](#) Subscribe us on YouTube for updates [http://www.youtube.com/channel/UCsSdGsFs8Cby3oxiMHTCNEg?sub\\_confirmation=1](http://www.youtube.com/channel/UCsSdGsFs8Cby3oxiMHTCNEg?sub_confirmation=1) PICKit2 is a USB powered device, that is it gets power from PC USB +5V power supply. USB microcontroller PIC18F2550 is the soul of the PICKit2. The USB Data+ and Data- from PC are connected to the D+ and..... Listed under: [Interfacing\(USB - RS232 - I2c -ISP\) Projects](#)



806. [Generic UART for Any Microcontroller](#) Communicating with a micro-controller at runtime, is a very useful facility. It can be used for debugging, or to send commands etc. One of the easiest available protocol to communicate is UART. It requires a pin for transmit and a pin for receive, and the GROUND..... Listed under: [Other Projects](#)



807. [Lab Test Bench-oscilloscope/waveform](#) Lab test bench For electrical engineering classes, basic lab equipment such as oscilloscopes and signal generators usually cost hundreds of dollars. In this project I want to implement the hardware and initial software for a small, affordable digital oscilloscope and waveform generator based off an..... Listed under: [Other Projects](#)



808. [Intelligent Tail Light](#) Some time ago the tail light of my bike stopped working. When I opened it, there was a small PCB with some electronics and a LED in it. The problem was the push button switch that did not function. I could have replaced the switch..... Listed under: [LED Projects](#)



809. [DEVCC Hello World](#) The flashing LED is a tried and tested way of getting your board working, but it is somewhat tired as well. Since we have been supplying the proto shield with the blueberry purchases I thought it would be a good idea to do something different..... Listed under: [LED Projects](#)



810. [RFID Reader – Access Control System](#) This device is a simple access control system which uses RFID cards. It is designed with PIC12F1822 microcontroller running on internal oscillator at 16MHz. It generates 125 KHz carrier frequency and decodes the respond data stream – format H10301- FSK modulation 26 bits only. These cards (made..... Listed under: [LED Projects](#)



811. [Android Control of Non-Arduino Based Micros, PIC Etc](#) This instructable describes how to use the free pfdDesignerV2 to create menus and charts for your non-Arduino based micro project. These menus and charts are then displayed by pfdApp on your Android mobile. No Android programming required. Half-Duplex operation is supported if your hardware/software does not support Full-Duplex. These instructions..... Listed under: [Other Projects](#)

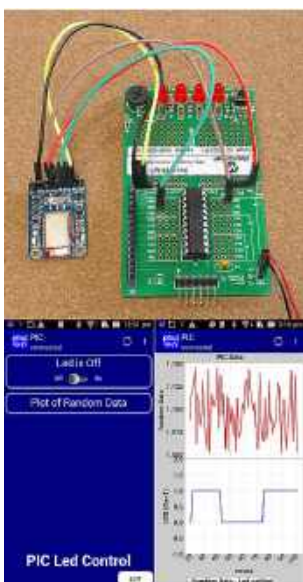

812. [Starting Programming With a Flow Chart](#) Starting to use PIC micro controllers for your projects? they are very useful but very frustrating when your programme just doesn't work. This is one way to sort out your ideas by drawing a flow chart. This is the way professional programmers often create their..... Listed under: [Microcontroller Programmer Projects](#)



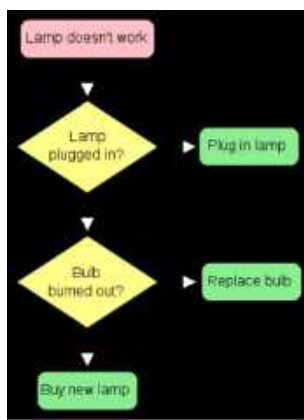

813. [Setting Up CloudX](#) In this tutorial, we will be learning on how to download and install necessary software required to write and do your first project with the CloudX Microcontroller, i will also be writing simple hello world project to test the complete setup. So, you've just bought, or are considering..... Listed under: [Microcontroller Programmer Projects](#)



814. [AVR32 Development Board at Home](#) This is my first instructable. So plz comment and help me out with any mistakes i might commit .I have created a pcb for avr 32 ,its a development board .I saw that there none online with pcb that could be done at home so thought..... Listed under: [Home Automation Projects](#)



815. [Debouncing Interrupts With MPIDE Part 1: Brute Force](#) It's about time isn't it? Welcome back! If you've been following my l'bles up to this point, I've shown you two different ways to set up interrupts in MPIDE using attachInterrupt() and setIntVector(). In the first of those tutorials, I explained what "bounce" was, and why "debouncing" was important,..... Listed under: [Robotics - Automation Projects](#)



816. [LEGO Nikon IR Remote](#) (You can skip the paragraph) My sister has a Nikon D60 camera and is an active photographer. She had been begging for a remote control for the camera and this particular model doesn't have the option of wired remote, which would have been easier to make..... Listed under: [Video - Camera - Imaging Projects](#)



817. [Digital Measuring Tape](#) I always was thinking of a measuring tape that never ends and be able to measure very long things. So I decided to make a small odometer and use it as a digital measuring tape. I used a PIC16F819 microcontroller and a sensor from an old computer mouse (the..... Listed under: [Other Projects](#)



818. [Paintball/Ballistic Chronograph](#) Create a low-cost Paintball Chronograph for less than \$40! A ballistic chronograph is a device that records the velocity of a projectile. This particular chronograph I have made has only been tested with a paintball gun and it is relatively simple to make. I have..... Listed under: [Other Projects](#)















819. [CHR's 8X8X8 LED Cube Revisited With Improvements!](#) I want to acknowledge that so many here contributed ideas and support, and although there are too many to name now, I did want to acknowledge my gratitude for all that contributed to the project. I am so happy that the printed circuit boards I developed..... Listed under: [LED Projects](#)

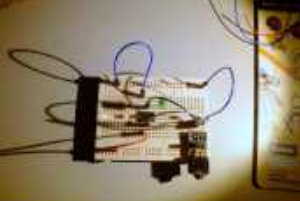

820. [Building Your Own Micromite Companion Minicomputer](#) The Micromite Companion Minicomputer is the next generation in the Pocket Mini Computer series. It is the combination of two Open Source systems, the Micromite software, a PIC32 creation by Geoff Graham, and the Parallax Propeller, a recently "Open Sourced" chip by Chip Gracey. By..... Listed under: [Other Projects](#)



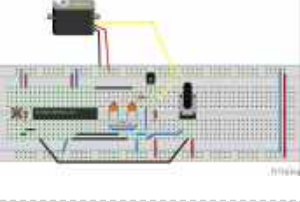
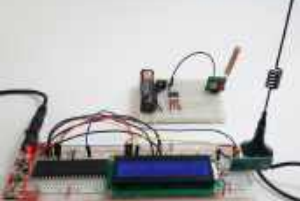





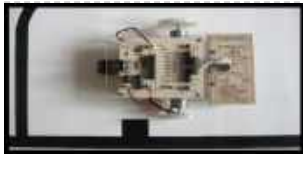

821. [Microcontroller Register Manipulation](#) I'm always amazed at the new technology that is constantly coming out that allows hobbyists like myself access to powerful and cheap microcontrollers like the Arduino or chipKIT development boards. They are easy to program and easy to use, but sometimes the code can get..... Listed under: [Other Projects](#)

822.  [Computer Controlled Traffic Light](#) I made this computer controlled traffic light for my work to show the status of the software being build, but I will spare you the details. This was also my first home project with a PIC controller. The traffic light is using an old Ikea..... Listed under: [LED Projects](#)
823.  [Convert an ATX PSU Into a Bench PSU That Measures Current](#) In this instructable I'm going to show you how to convert an old ATX power supply to a bench power supply that also displays the current drawn for each voltage rail on an LCD display. Features: The PSU uses a 20x4 LCD display to show..... Listed under: [Other Projects](#)
824.  [PIC18 Development Board With Ethernet and USB](#) In this instructable I'm going to show you how to make your own PIC18 development board that features both Ethernet and Full Speed USB 2.0 at a low cost. Features: The development board is based on a PIC18LF4553 microcontroller. The microcontroller features a Full Speed..... Listed under: [Internet - Ethernet - LAN Projects](#)
825.  [Low Cost IC Test Clip for PIC ICSP](#) I made the Low Cost IC Test Clip for ICSP of PIC Microcontrollers. [http://neo-sahara.com/wp/ic\\_test\\_clip](http://neo-sahara.com/wp/ic_test_clip) Step 1: Step 2: Put the copper tape on the cloth peg and cut the tapes as 2.54mm pitch. Step 3: Solder cables. Step 4: Use like this pictures. [http://neo-sahara.com/wp/ic\\_test\\_clip](http://neo-sahara.com/wp/ic_test_clip) Source:..... Listed under: [Other Projects](#)
826.  [Lets Program a PIC Microprocessor](#) OK How hard can programming a PIC microprocessor be? Well it depends, some are harder than others for several reasons, The programming language, the type of microprocessor, the ease of use of the editing software and most importantly how familiar you are with it all..... Listed under: [Microcontroller Programmer Projects](#)
827.  [Programming the PmodOLEDrgb on the ChipKIT Pro MX7](#) LED screens are everywhere. Chances are you're using one to read this right now. With the release of Digilent's PmodOLEDrgb, now you can program one yourself! Step 1: Materials For this project you'll need: chipKIT Pro MX7PmodOLEDrgbMicro USB cableMPIDE installedPython installed (for converting bitmaps)PmodOLEDRGB libraries..... Listed under: [LED Projects](#)
828.  [PIC 12F675 Programmer/OscCal Restore/Tester](#) One of my circuits that I build quite often (20 - 40 at a time), uses a PIC 12F675. I had the following issues: The boards that I make, does not have in-circuit programming capabilities. This is to allow for a small PC board layout..... Listed under: [Microcontroller Programmer Projects](#)
829.  [Remote Controlled Rolling Shutter](#) At home I have a few electrical Rolling Shutters that are controlling via a switch with which you can let them go up or down. When the Rolling Shutter reaches the end of its up or down movement, the motor of the Rolling Shutter stops..... Listed under: [Motor Projects](#)
830.  [DIY- UNIVERSAL PIC AND AVR PROGRAMMER](#) I am presenting a best class USB Universal Programmer for both PIC and AVR Microcontrollers. In our present market the universal programmer supporting much devices with combination of PIC and AVR are not in common, they are expensive also. This programmer is very cheap which..... Listed under: [Microcontroller Programmer Projects](#)
831.  [Stand-alone Heart Rate Meter](#) This instructable describes how to build a stand-alone heart rate meter using Easy Pulse mikro sensor and mikroElektronika's clicker 2 for PIC18FJ board. An OLED W click board is also used to display the heart beat rate in beats per minute (BPM). The above figure shows all the things you would..... Listed under: [Other Projects](#)
832.  [Servo Control With Microchip Microcontroller](#) In this instructable I want to show you how to control a servo using a microcontroller (18F2550) and how to avoid using an unknown library to control a servo. Step 1: Materials Power supplyBreadboardWires or jumpersResistorsTransistor or optocouplerMicrochip microcontrollerPICC Compiler(It could be another one, but..... Listed under: [Microcontroller Programmer Projects](#)
833.  [Wireless Communication Using Cheap 433MHz RF Modules and Pic Microcontrollers. Part 2](#) On the first part of this instructable, I demonstrated how to program a PIC12F1822 using MPLAB IDE and XC8 compiler, to send a simple string wirelessly using cheap TX/RX 433MHz modules. The receiver module was connected via a USB to UART TTL cable adapter to..... Listed under: [Wireless Projects](#)
834.  [Infra-Red Panel Remote Control](#) This project is a variation on the Remote Control Rolling Shutter project that I posted earlier, see: <https://www.instructables.com/id/Remote-Controlled...> The biggest difference is that I did not only prototype this project but I actually build it to be used in my home. At home I have..... Listed under: [Other Projects](#)
835. [Electronic Dimmer With Memory](#) At home I have a salt lamp. This lamp needs a regular small 15 Watt light bulb that lights up and warms up the lamp. When the lamp is switched on you normally should not dim the lamp because of the lamp heat that the..... Listed under: [Other Projects](#)

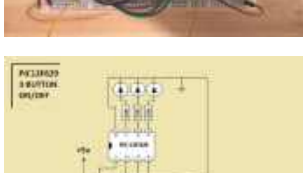



836.  [How to Make a PIC Programmer – PicKit 2 'clone'](#) Hi! This is a short Instructable on making a PIC programmer which acts as a PicKit 2. I made this because it is way cheaper than buying an original PicKit and because Microchip, the manufacturers of PIC microcontrollers and the PicKit programmer, provides schematics and..... Listed under: [Microcontroller Programmer Projects](#)
837.  [Complete Guide to Design an Advanced Line Follower Robot](#) Line follower is an autonomous robot which can detect a specific colored line painted on a surface of different contrast, such as white on black. In this project I used infrared transmitters and receivers to track the black strip on white surface. Due to the..... Listed under: [Robotics - Automation Projects](#)
838.  [RF Thermostat](#) This project described the first part of the following project: An RF Thermostat as described in this Instructable An RF Panel Relay, described in the following Instructables:<https://www.instructables.com/id/RF-Panel-Relay/> Some time ago I posted an Instructable about controlling an Infra Red panel with a remote control, see:..... Listed under: [Other Projects](#)
839.  [RF Panel Relay](#) This project described the second part of the following project: An RF Thermostat as described in the following Instructable: <https://www.instructables.com/id/RF-Thermostat/> An RF Panel Relay, described in this Instructable For an introduction on this project first read the description of the RF Thermostat. In short the RF..... Listed under: [Other Projects](#)
840.  [IR Remote Controlled Home Automation Using PIC Microcontroller](#) In this project, we are going to use a PIC microcontroller to remotely control few AC loads by just using an IR remote. Here we designed it on PCB using EasyEDA's online PCB designer and used their PCB designing services to order the PCB boards as shown..... Listed under: [Home Automation Projects](#)
841.  [Reaction Speed Timer](#) Many, many years ago – when I was young - I visited the Evoluon in Eindhoven, The Netherlands. At that time it had all kind of technical stuff you could see and you could play with. Nowadays it does no longer exist in that form..... Listed under: [Clock and Timer Projects](#)
842.  [Simple 3 Button On-off With 12f629 \(mikroC\)](#) a simple 3 buttons on-off with pic12f629. it's written with MikroC Step 1: The Code... start the code with "int"----- int x0,x1,y0,y1,z0,z1; // with this the GPIO outputs could stay on or off void main() { GPIO = 0x00; // all outputs are 0 CMCON..... Listed under: [Other Projects](#)
843.  [How to Create a Garage Door Proximity Sensor](#) If you don't have a reverse backup radar system in your car, or if you park forward in your garage, you probably know this feeling of "am I too close, am I gonna hit the wall?". There are a lot of ways to resolve this..... Listed under: [Sensor - Transducer - Detector Projects](#)
844.  [Intelligent access control based on STONE TFT LCD and ESP32](#) Brief Introduction Smart home is becoming more and more common with the development of technology, this article will focus on the security aspects of the intelligent access control project. This article uses STONE's touch screen to send commands to the MCU to control the relay..... Listed under: [LCD Projects](#)
845.  [WiFi Car Using NodeMCU](#) We have build car using many transmission technologies. But what about a WiFi Controlled Car? Actually speaking..Wifi is till now the most promising technology and engineers are using that tech to improve it more and more. This tech is most popular today and will remain..... Listed under: [Wifi - Wlan Projects](#)
846.  [Tea Light Charger Monitor](#) Some time ago I bought some Electric Tea Lights that are charged using a wireless charger. This charger has a power LED that shows when the Lights are charged. After 10 hours of charging the charges switches off. It seemed, however, that there is an..... Listed under: [LED Projects](#)
847. [Analog Input Using PIC Microcontroller \(assembly Language\)](#) So this tutorial should show you how to get an analog input using a PIC microcontroller (I'm using a PIC16f887) in assembly language. You may have a demo board (which makes programming way easier) just a chip.

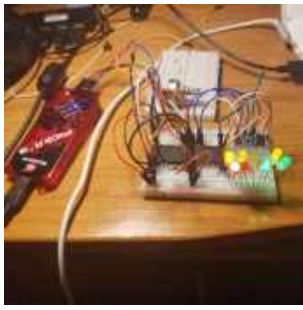

I'm using just a plain 40 pin chip..... Listed under: [Microcontroller Programmer Projects](#)

848.



[Infra-Red Panel Timer](#) In one of the rooms upstairs in my house I have an Infra Red panel. When I am in that room and I switch on this panel I sometimes forget to switch it off, which is a waste of valuable energy. In order to prevent..... Listed under: [Clock and Timer Projects](#)

849.



[PIC16F84 Digital Clock / Silent Alarm](#) This is one of my earliest projects as a maker. Actually, I've been doing so since I was a little child. And this one is from my early days in Embedded Software. This is a digital clock project that I've working on since 2006. It's..... Listed under: [Clock and Timer Projects](#)

850.



[USB NEC Infra-Red Transmitter and Receiver](#) This project is a spin-off of another project I am working on and since there is a Remote Control 2017 contest on Instructables I thought I post this project. So if you like this project, please vote for it. Thanks. As you may know, I..... Listed under: [Other Projects](#)

851.



[Bluetooth Controlled- Obstacle Avoidance Robot Car Using PIC32 Microcontroller](#) "Robot-Car: Design Fused with Obstacle Avoidance Technology" Recently, there is an intensive research undertaken in the field of intelligence robotics and autonomous mobile robot applications. Through the this project we wanted to explore this field by building a robot car that can potentially avoid the..... Listed under: [Bluetooth Projects](#)

852.



[Wireless Doorbell Receiver](#) This project describes the second part of the following two projects: A wireless doorbell transmitter as described in the Wireless Doorbell Transmitter Instructable. This Instructable also gives some introduction to these projects. A wireless doorbell receiver described in this Instructable. The wireless doorbell receiver will make a..... Listed under: [Wireless Projects](#)

853.



[Wireless Doorbell Transmitter](#) This project describes the first part of the following two projects: A wireless doorbell transmitter as described in this Instructable A wireless doorbell receiver to be described in the Wireless Doorbell Receiver Instructable When I am sitting in the backyard of my house I cannot hear it..... Listed under: [Wireless Projects](#)

854.



[Charlieplexing Xmas Tree](#) Xmas coming and we need some new hardware. Xmas hardware has to be green + white + red + blinking. So PCB is green + white, then add some blinking LEDs and we are done. I have lot of "Right Angle Side View Red Clear..... Listed under: [LED Projects](#)

855.



[Analog Digital Clock](#) The reason for making this clock was because my original IKEA clock did not work anymore and I really liked the housing of this clock. I found it a waste to throw the clock away and decided to re-use it for an analog / digital..... Listed under: [Clock and Timer Projects](#)

856.



[Tea Light Clone](#) I got to the result so it requires a bit more reading. At home we have quite some electronic tea lights, the ones from Philips that can be charged wirelessly. I have made an Instructable before related to this topic, see Tea Light Charge Monitorr. After..... Listed under: [Other Projects](#)

857.



[JALPIC One Development Board](#) If you follow my Instructables projects you know that I am a big fan of the JAL programming language in combination with the PIC Microcontroller. JAL is a Pascal like programming language developed for the 8-bit PIC microcontrollers of Microchip. Most people know the Arduino..... Listed under: [Development Board - Kits Projects](#)

858.











[Digital Controlled Linear Power Supply](#) In myteenage years, about 40 years ago, I created a dual linear power supply. I got the schematic diagram from a magazine called 'Elektuur', nowadays called 'Elektor' in The Netherlands. This power supply used one potentiometer for the voltage adjustment and one for the current..... Listed under: [power - energy projects](#)





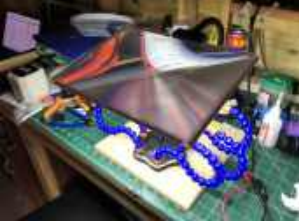
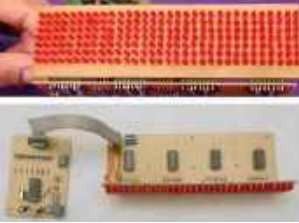
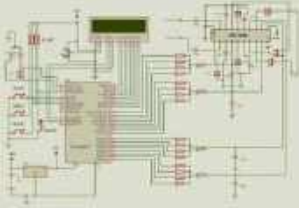
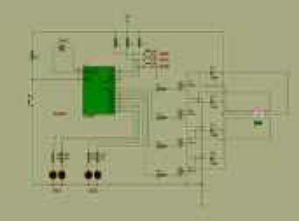
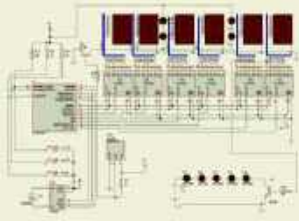







859.



[Cat Repellent](#) To start with, I do not hate cats but I love birds. In my garden we have some open cages where birds can enter and leave as they please. They can find food and water there. Unfortunately sometimes a cat from the neighborhood enters my..... Listed under: [Other Projects](#)











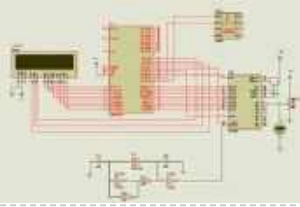



860.  [VFD Display for the TI83+ Calculator](#) This project builds upon the PIC/TI83+ interface developed by ThomasHenry (see Nuts & Volts August 2013 – A Mathematics Engine for Microcontrollers). Acknowledgment, appreciation, and kudos to him for writing the TI-library for Great Cow Basic that made this project possible. When I recently re-discovered..... Listed under: [Calculator Projects](#)
- 
861.  [Illuminated Cubes](#) This project is a follow up of the Illuminated Presents project that I posted earlier. My wife really liked the Illuminated Presents but kept them as Cubes and did not put a bow around it to turn them into presents. Because of this success I created a..... Listed under: [Other Projects](#)
- 
862.  [DC Motor Control Unit for an Old Controller](#) Brief Description: The main goal of this project is to design a DC motor controller, We had a DC motor controller that its control circuit has been damaged. Here we are attempting to design a new control circuit for the controller. But before we can..... Listed under: [Motor Projects](#)
- 
863.  [Model Train Speedometer](#) This project started off being based on an Arduino UNO. And it worded ok, I found the software published on the internet. For example <https://forum.arduino.cc/t/model-railroad-speedome...> But I wanted to make the device smaller, neater and if possible to improve the software. With this version you can..... Listed under: [Metering - Instrument Projects](#)
- 
864.  [Ultimate Soldering LED Light With A4 Sheet Magnifier](#) I've always wanted a better way of seeing close up when carrying out soldering or working with PCB's or small components, I've tried the visor magnifiers and never been to happy as your head is backwards and forwards trying to focus and you have to..... Listed under: [LED Projects](#)
- 
865.  [SCROLLING LED TEXT CIRCUITS PIC16F84 PIC16F628 PIC18F452](#) PIC16F84, PIC16F628, PIC18F452 circuits made with 16 32 60 Column Marquee isis proteus simulation files are one of many circuits can simulate. Source codes and codes on the circuit's writing projects can be done by modifying the different advanced... Electronics Projects, Scrolling LED Text Circuits PIC16F84 PIC16F628..... Listed under: [LED Projects](#)
- 
866.  [DIGITAL TONE CONTROL CIRCUIT WITH PIC16F877 LM1036](#) Were made by combining the LM1036 integrated circuit PIC16F877. BASS, TREBLE, BALANCE, VOLUME settings on the LCD screen is made in my image as a 15 something in the shade echelons. In addition, this circuit easily adapted to integrate... Electronics Projects, Digital Tone Control Circuit with PIC16F877..... Listed under: [Sound - Audio Projects](#)
- 
867.  [STEPPER MOTOR CONTROL CIRCUIT WITH PIC16F84A MOSFET](#) PIC16F84 stepper motor control circuit is the button to the right to the left button is pressed, the motor rotates continuously in the opposite direction to the right Doderer stop button will stop the motor. The engine speed is... Electronics Projects, Stepper Motor Control Circuit with PIC16F84A..... Listed under: [Motor Projects](#)
- 
868.  [CLOCK THERMOMETER CIRCUITS WITH PIC16F628 PICBASIC PRO](#) Made with clock and thermometer 16F628 PIC-7 Circuit Friends, I have realized various clock and thermometer with PIC16F628A circuit I explain below. The temperature sensor used in each of the projects is DS18B20. Clock Thermometer Circuit-1: In this circuit,... Electronics Projects, Clock Thermometer Circuits with PIC16F628 PICBasic..... Listed under: [Clock and Timer Projects](#)
- 
869.  [MICROCONTROLLER GSM ALARM AND CONTROL CIRCUITS](#) Now quite a popular topic with Cell Phone Control with Microchip pic series for those who want to do these types of projects that could give clues will limp a few projects, including projects located in Atmella in 1... Electronics Projects, Microcontroller GSM Alarm and Control Circuits "avr..... Listed under: [Clock and Timer Projects](#)
- 
870.  [RJ45 UTP CABLE TESTER CIRCUITS PIC16F627 PIC16F84](#) RJ45 UTP cable test, there are two different circuits to control the strength of the circuits made with PIC asm code and the PCB (circuit 2) files have our own UTP RJ45 Cable Tester Make your device The only... Electronics Projects, RJ45 UTP Cable Tester Circuits PIC16F627..... Listed under: [power - energy projects](#)
- 
871.  [PIC18F4550 CONTROL STEPPING MOTOR VIA USB INTERFACE DELPHI](#) This is an example that demonstration how to control some devices via USB interface.The PC software program with delphi. Feature : – CPU PIC18F4550 with full speed USB interface at 48MHz. – USB 2.0 compliance – Use on-chip USB... Electronics Projects, PIC18F4550 Control stepping motor via USB..... Listed under: [Motor Projects](#)

872.  [PIC18F2455 OBD2 USB TO RS232 CONVERTER CIRCUITS](#) USB-to-RS232 converter on desktop computers COM port does not work well, but most of them are not useful for notebook laptop com-port Serial not found. Based on PIC18F2455 microcontroller circuit diagram hex driver software and observation programs there. USB... Electronics Projects, PIC18F2455 OBD2 USB to RS232 converter..... Listed under: [Interfacing\(USB - RS232 - I2c -ISP\) Projects](#)
873.  [PIC16F870 LMX2306 PLL FM TRANSMITTER CIRCUIT](#) FM PLL transmitter circuit 12V supply 500mW has the power circuit PIC16F870 and LMX2306 integrated based on the simple circuit of a single coil are killers though PLL (phase-locked loop-Phase-locked loop) circuits without line would sooner or later will... Electronics Projects, PIC16F870 LMX2306 PLL FM Transmitter Circuit "microchip..... Listed under: [Radio Projects](#)
874.  [PIC12F675 PC PROGRAMMABLE SECURITY SYSTEM](#) This project uses the 12F675, it was chosen because of its low cost, A/D convertor and flash memory. This security system was designed to be used in a simple installation with just a hidden switch and not a keyboard.... Electronics Projects, PIC12F675 PC Programmable Security System "microchip projects,..... Listed under: [Security - Safety Projects](#)
875.  [PIC18F2455 PIC-TENGU CCS C TALKING ROBOT](#) Funny robot application is a fun app 😊 Speaking software installed on PIC18F2455 with CCS C prepared according to the audio signal around talking smiley made of LEDs. Also working in windows environment with source code in JAVA based... Electronics Projects, PIC18F2455 PIC-Tengu CCS C Talking Robot "ccs..... Listed under: [Robotics - Automation Projects](#)
876.  [PIC16F876 PWM MOTOR SPEED CONTROL](#) CCS PCM compiler pic16f876 microcontroller circuit prepared with software installed on the PIC hex output FETs are driven IRL1004 MOSFET PWM frequency of 10 kHz with the engine. Prepared with eagle pcb circuit and printed circuit board file source... Electronics Projects, PIC16F876 PWM Motor Speed Control "ccs c..... Listed under: [Motor Projects](#)
877.  [PIC16F628 RGB LED CONTROL CIRCUIT](#) RGB LED control circuit 16F628 microcontroller based on the software prepared by JAL. Source code and circuit diagrams are available. According to information from the computer via serial port LEDs working with Visual Basic code for the application of... Electronics Projects, PIC16F628 RGB LED Control Circuit "led projects,..... Listed under: [LED Projects](#)
878.  [PWM MOTOR AND POWER CONTROL WITH PIC16F84](#) PIC16F84 4 MHz crystal is connected 100 Hz PWM output produces a pulse width of 10 separate levels are adjusted these values asm software vary from circuit only engine that not all GUS control applications can be used on... Electronics Projects, PWM Motor and Power Control with..... Listed under: [Motor Projects](#)
879.  [PIC12C509 REMOTE RECEIVER TRANSMITTER](#) Summary infrared remote control for video and television transmitter sent from the terminal and control code to determine, on, off, and can be reversed. NEC Matt Howe Institute consumer electronics products that conform to the transmitter, if possible on... Electronics Projects, PIC12C509 Remote Receiver Transmitter "microchip projects, microcontroller..... Listed under: [Metering - Instrument Projects](#)
880.  [NIMH NICD BATTERY CHARGER CIRCUIT PIC16F877 PIC16F876](#) NiCd NiMH Charger Circuit The accu cyler project presented here is an excellent solution for charging and discharging NiCd and NiMH accumulators for R/C modelers and others who make use of these accumulator types. With its performance it is... Electronics Projects, NiMH NiCd Battery Charger Circuit PIC16F877..... Listed under: [Battery Projects](#)
881.  [PIC16F84A SIMPLE LED CIRUIT](#) A very simple application is carried out with the PIC16F84 PIC programming can be useful for beginners People Summer program after program with MPLAB ASM extension Alt + F10 on the keyboard and save when you press Go MPLAB... Electronics Projects, PIC16F84A Simple LED Ciruit "led projects, microchip..... Listed under: [LED Projects](#)
882.  [BRIDGE BIDIRECTIONAL DC MOTOR SPEED CONTROL PWM PIC12F629](#) Bridges connected motor speed control circuit 12f629 controller based on the PWM method and the motor is driven integrated outputs 2N7002 MOSFETs reinforced with assembly language prepared by the source. Asm,. Hex code and eagle prepared with diagrams, printed... Electronics Projects, Bridge Bidirectional DC Motor Speed Control..... Listed under: [Motor Projects](#)
883.  [PIC12C509 PWM ELECTRONIC SPEED CONTROL](#) Electronic speed control circuit made with micro 12c509 IRL2203 integrated MOSFET outputs IRL9Z34N and strengthen motor speed control is provided with all source files belonging to the project (asm code, eagle pcb, schema) shared. Authors speed control circuit using... Electronics Projects, PIC12C509 PWM Electronic Speed Control "microchip projects,..... Listed under: [Other Projects](#)

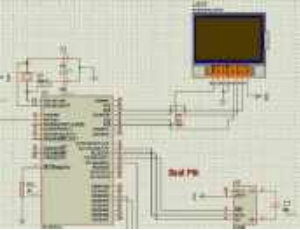

884.  [USB BATTERY CHARGER CIRCUIT WITH PIC16F629](#) USB Battery Charger Circuit Pic16f629 microcontroller integrated with the computer's USB port 1 100-1000 The AAA battery charging circuit charging time the battery current compared to 1-14 hours of battery is full time dual-color LED and buzzer and warning... Electronics Projects, USB Battery Charger Circuit with PIC16F629 "battery..... Listed under: [Interfacing\(USB - RS232 - I2c -ISP\) Projects](#)
885.  [REMOTE DIGITAL VIDEO SELECTOR WITH PIC16F628 CCS C](#) Three-way component video input, component video output way Three-way fiber-optic digital input, optical fiber all the way digital / coaxial output Infrared Remote Control LCD (,Cool,) LCD status display (this function is not necessary, but taking into account comparative... Electronics Projects, Remote Digital Video Selector with PIC16F628..... Listed under: [Game - Entertainment Projects](#)
886.  [LCD-VFD CONTROL CIRCUITS PIC16F873 PIC16F628 USB RS232](#) USB LCD/VFD Controller is a HD44870 based LCD/VFD controller via USB interface. The control command is compatible with Matrix-Orbital's LCD module. So, you can use any MO friendly software to control this baby. Such as LCDControl. The firmware are based... Electronics Projects, LCD-VFD Control Circuits PIC16F873 PIC16F628 USB..... Listed under: [Interfacing\(USB - RS232 - I2c -ISP\) Projects](#)
887.  [CABIN CONTROL WITH PIC18F2550 PIC18F2520 CCS C](#) Two interesting projects Inverer the-PIC and Terra PIC terra obviously with pets or aquarium cabinet temperature of the light feeding control enables Inveria the air control may be associated with exactly can not bring my project to publish reasons... Electronics Projects, Cabin Control with PIC18F2550 PIC18F2520 CCS..... Listed under: [Other Projects](#)
888.  [ULTRASONIC DISTANCE METER CIRCUIT WITH PIC16F873](#) Ultrasonic Distance Measurement circuit protel98s prepared with all the resources given circuit pcb drawing has asm and hex source code. Ultrasonic detection circuit pic assembly PIC16F873 microcontroller used in the "UCM R4OK1" with ultrasonic transmitters used ultrasonic signal measurement... Electronics Projects, Ultrasonic Distance Meter Circuit with PIC16F873 "microchip..... Listed under: [Metering - Instrument Projects](#)
889.  [COMPUTER CONTROLLED SMART HOME PROJECT WITH PIC16F873](#) Smart home automation control project your computer on the control program and PIC16F873 on board with the circuit bulb lights on the severity of your air conditioner temperature or any engine speed ayarlayabilirsiniz.sens you and help through a program... Electronics Projects, Computer Controlled Smart Home Project with..... Listed under: [Home Automation Projects](#)
890.  [PHILIPS RC5 REMOTE DIMMER WITH PIC16F628](#) The purpose of the remote dimmer control circuit TV (Philips RC5 code) 220V lamp with brightness adjustment can be made. Increase and decrease +10, -10 and +1, -1 as is done in two ways. Circuit PIC16F628, and 4N35 MOC3021've... Electronics Projects, Philips RC5 Remote Dimmer with PIC16F628 "microchip..... Listed under: [Robotics - Automation Projects](#)
891.  [ANTENNA CONTROL X-Y WITH PIC16F876 PICBASIC](#) XY antenna, motor control circuit PIC16F876 with 4 buttons on the control board can be made Microcode Studio Plus software and prepared with Pic basic resource. Press code and PCB files there. Control System Antennas (X and Y) This... Electronics Projects, Antenna Control X-Y with PIC16F876 picbasic "microchip..... Listed under: [Other Projects](#)
892.  [AT89S52 8051 RF DC MOTOR SPEED CONTROL](#) Wireless within a certain area with a control circuit for controlling the speed of DC Motor. Work, should I use to reach my goal I began to identify materials. These materials AT89S52 microcontroller, our independent auditor by the company... Electronics Projects, AT89S52 8051 RF DC Motor Speed..... Listed under: [Motor Projects](#)
893.  [0-25V 2.5A DIGITAL POWER SUPPLY CIRCUIT LCD DISPLAY PIC16F873P](#) Digital power supply circuit with microcontroller pic16f873p conducted and current sensing, power transistors (tip142) is used in the control LM324 op amp. LCD display showing information on the current and voltage source project pic code (asm, hex) and with... Electronics Projects, 0-25V 2.5A Digital Power Supply Circuit..... Listed under: [LCD Projects](#)
894.  [CNC CONTROL INTERFACE WITH PIC12F629 AND 74HC244N](#) CNC Project on via a computer paralelport lpt with the various engine controls allows you to make a circuit on the circuit input and output sections terminals is done via the lpt 74HC244N integrated depending on the pcb printed... Electronics Projects, CNC Control Interface with PIC12F629 and..... Listed under: [CNC Machines Projects](#)
895.  [THREE-AXIS STEPPER MOTOR DRIVER CIRCUIT WITH PIC12C508](#) From the computer's parallel port 3 axis cnc stepper motor control circuit can be used for projects PIC12C508 microcontroller (3 pieces) lpt port connected to the output MOSFETs in there. PCB material list, diagrams, code's documentation. Motor control drive... Electronics Projects, Three-Axis Stepper Motor Driver Circuit with..... Listed under: [Motor Projects](#)

896.  [89C51 8051 VOLTMETER THERMOMETER DS1621 ADC0808](#) ADC 0808 standard data acquisition systems many components on a single chip host is a member of ADC 0808 8-bit flip makes the process and addresses from input latch 8-channel data selection (multiplexer) and microprocessor compatible with the associated ... Electronics Projects , 89C51 8051 voltmeter thermometer..... Listed under: [Metering - Instrument Projects](#)
897.  [CONTROL OF SATELLITE ANTENNA WITH PIC16F877](#) the dual-axis rotors control interface . Here is a low cost automatic antenna rotor controller specifically developed for amateur radio satellite tracking operations. This rotor control interface is quite simple to construct. The circuit consists only one PIC 16F877... Electronics Projects, Control of Satellite Antenna with PIC16F877 "microchip..... Listed under: [Wireless Projects](#)
898.  [CALCULATION OF BODY LENGTH WITH 8051 AND DS89C430](#) In this project, which is designed using DALLAS DS89C430 microcontroller (in simulation AT89C51RC2) circuit and a marching band, calculated on the length of the body, the LCD display was performed. Circuit consists of three parts. In the first part,... Electronics Projects, Calculation of Body Length with 8051..... Listed under: [Calculator Projects](#)
899.  [AT89C51 8051 GRAPHIC LCD ANIMATION](#) GLCD Animation circuit voltage is applied to the currently displayed map of Turkey comes first. Subsequently, the Turkish flag and a picture of Mustafa Kemal Atatürk, the next step is to come. Art world will begin to come after ... Electronics Projects, AT89C51 8051 Graphic LCD Animation " 8051 example, apr..... Listed under: [LCD Projects](#)
900.  [PIC16F628A LINE FOLLOWING ROBOT PROJECT](#) Line following robot project with a more powerful battery and the engine was a good guess but it can result in opportunities, folks have the best hand made based on PIC16F628A circuit used for the detection sensor CNY70 L298... Electronics Projects, PIC16F628A Line following robot project "microchip projects,..... Listed under: [Robotics - Automation Projects](#)
901.  [AT89C51 L293D DC MOTOR WITH DOOR CONTROL CIRCUIT](#) he main purpose of the circuit is to control the gate of the house. This DC motor and provided with two limit switches is provided by mechanical parts. The two buttons open and close the circuit inside is available.... Electronics Projects, AT89C51 L293D DC Motor with Door..... Listed under: [Motor Projects](#)
902.  [AT89C51 SQUARE WAVE SIGNAL GENERATOR](#) Signal generator test is often the recipients of the amplifiers used in the test and repair of this equipment. Used as the signal source. Wave detector, radio frequency used in places such as bridges. Integrated signal generator, the steady... Electronics Projects, AT89C51 Square Wave Signal Generator "8051 example,..... Listed under: [Wireless Projects](#)
903.  [PIC16F84 MIDI 32-CHANNEL DECODER CIRCUIT](#) Midi 32-channel decoder circuit made with PIC16F84 microcontroller pic çoklanıp with 74LS574 outputs given the output circuit uln2803 12v dc and dc 5v (integrated supply) is working with a list of materials and source code are printed circuit boards.... Electronics Projects, PIC16F84 Midi 32-channel decoder circuit "microchip projects,..... Listed under: [Other Projects](#)
904.  [PROTEUS ISIS 3310 LCD LIBRARY PICBASIC PRO, CCS C APPLICATION](#) Nokia phone lcd circuits are made beautiful with the old phone is good for this job 😊 evaluate Proteus model file for this type of study can be useful There are two buy two degrees of application notes given... Electronics Projects, Proteus isis 3310 LCD Library PICBasic..... Listed under: [Phone Projects](#)
905.  [0-30V DC VOLTAGE CURRENT POWER MONITOR](#) DC POWER SUPPLY CONTROL SYSTEM 0-30V DC output capable circuit protected power supply to the crash the pursuit of power is a system which can be installed simply. Since the output voltage does not interfere with the regulation of... Electronics Projects, 0-30V DC Voltage Current Power Monitor "microchip..... Listed under: [power - energy projects](#)
906.  [PIC17C77 MIDI CONTROL CIRCUIT MC14067](#) There a few years, PC began to be powerful enough to réaliserde software synthesis. For my part, I discovered the real time software synthesis with ReBirth on my Pentium 166MHz MMX. Of course, software synthesis exist on the PC,... Electronics Projects, PIC17C77 Midi Control Circuit MC14067 "microchip projects,..... Listed under: [Microcontroller Programmer Projects](#)
907.  [27C128 FREQUENCY GENERATORS](#) The originality of this description is that the generation of tones BF is made using a DDS . And this not by using a special build , but easy to find in the drawer bottoms circuit components . The... Electronics Projects, 27C128 Frequency Generators "microcontroller projects, The originality..... Listed under: [Other Projects](#)
908. [USING DS1668 DIGITAL POTENTIOMETER WITH PIC16F877](#) Maxim DS1868 (digital potentiometer) and isis Proteus Simulation Using PIC16F877A Before starting the simulation in zipped files LIBRARY files in the folder "C: \ Program Files \ Labcenter Electronics \ Proteus 6 Professional \ LIBRARY" into; MODELS files in... Electronics Projects, Using DS1668 Digital Potentiometer with PIC16F877 "microchip..... Listed under: [Metering - Instrument Projects](#)



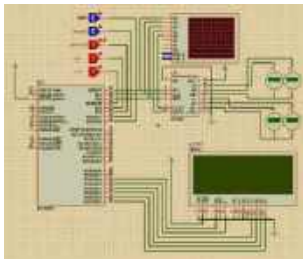

909.



[PIC16F84 SIMPLE LED BLINK PIC-C](#) In this project, I PIC16F84A microcontroller PORTB bits to 0 (RB0) LED (light emitting diode) is connected. In the project, this LED is extinguished and burned at intervals of 250 milliseconds. was operated with a 4MHz crystal microcontroller. RB0... Electronics Projects, PIC16F84 Simple LED Blink PIC-C "led projects,..... Listed under: [LED Projects](#)

910.



[ELECTRIC BIKE MOTOR CONTROL CIRCUIT TC4420 PWM PIC16F819](#) Motor control circuit PWM method used PIC16F819 output microchip product tc4420 high speed 6 amp mosfet driver used MOSFETs, the two pieces irf2907 also switched MOSFETs current drawn to detect tlv2461 op amp made with 0.01ohm shunt resistor current... Electronics Projects, Electric Bike Motor Control Circuit TC4420..... Listed under: [Motor Projects](#)

911.



[LEGO ROBOT PROJECT WITH PIC16F877 PIC ASSEMBLY](#) Two of the PIC16F877 microcontroller based on harsh economics Robot Barrier lego robot used a lot in part lego robot can be said also tip31, tip32 bridge motor driver with transistors have a more solid thanks to the movable... Electronics Projects, Lego Robot Project with PIC16F877 PIC..... Listed under: [Robotics - Automation Projects](#)

912.

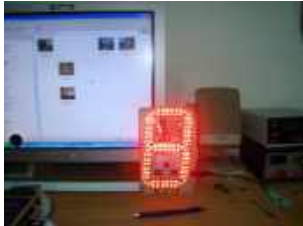

[LARGE 7-SEGMENT DISPLAY CIRCUIT ULN2803 PIC16F876A](#) Large size also display the prices are expensive, but they also have a limit if you make yourself big size LED display can achieve. Led display pic16f876 used in the control circuit of the LEDs are driven by uln2803... Electronics Projects, Large 7-Segment Display Circuit ULN2803 PIC16F876A "ccs..... Listed under: [LED Projects](#)

913.



[PIC16F628 STEPPER MOTOR CONTROL LMD18245](#) Stepper motor control, drive circuit PIC16F628 microcontroller used in motor control LMD18245 3 Amps, 55 Volts had integrated DMOS full-bridge motor driver. Prepared by the working frequency of 20MHz PIC software assembly step control all sources of project (PCBs,... Electronics Projects, PIC16F628 Stepper motor control LMD18245 "microchip projects,..... Listed under: [Motor Projects](#)

914.



[PIC16F877 NOKIA 3310 LCD DISPLAY IR REMOTE RC5 CONTROL](#) Remote control circuit nokia 3310 LCD screen used in the PIC16F877 microcontroller can be used rc5 protocol detailed frequency information is also given on other control systems. Printed circuit board pcb eagle and schema files as well as resources... Electronics Projects, PIC16F877 Nokia 3310 LCD Display IR..... Listed under: [LCD Projects](#)

915.



[PIC16F877 ISA ETHERNET WEB SERVER PROJECT](#) The PIC16F877 microcontroller, prepared with activated an old ISA ethernet (3com ether Link) Used guess PIC internet connection with an application I'm not sure 😊 circuit aim could not understand the pic programming dealing with people who can solve... Electronics Projects, PIC16F877 ISA Ethernet Web Server Project "microchip..... Listed under: [Internet - Ethernet - LAN Projects](#)

916.



[MULTI-VOLTAGE METER WITH PIC18F2550 PICBASIC PRO](#) PIC Microcontroller with multi-voltage measurement, display (LCD) a good example for software pic basic prepared with pic18f4455 RE3, RA0, RA1, RA2, pins and the 4-channel voltage measurement can be made circuit as an example 5 .... 12V DC Voltage... Electronics Projects, Multi-Voltage Meter with PIC18F2550 Picbasic PRO "microchip..... Listed under: [Metering - Instrument Projects](#)

917.



[PIC16F84 AMMETER CIRCUIT 0-80A UGN3503](#) PIC16F84 Ammeter, ampere meter circuit pic16f84 microcontroller has been made with the current sensor is used for UGN3503 hall effect sensor output op amp with integrated lm358 strengthened pic16f84 RB0 pin connecting led display current information (Its542r) displays on... Electronics Projects, PIC16F84 Ammeter Circuit 0-80A UGN3503 "microchip projects,..... Listed under: [Metering - Instrument Projects](#)

918.

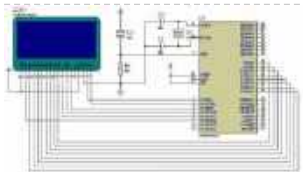

[AT89C51 ANIMATED BMP GRAPHIC LCD DISPLAY](#) AT89C51 microcontroller controlled Animated BMP project using Graphic LCD Display 128x64 project keil source code and proteus isis simulation schematic files Graphic LCD Animated BMP Schematic project files: FILE DOWNLOAD LINK LIST (in TXT format): LINKS-2374.zip author: Cihangir Kılıç... Electronics Projects, AT89C51 Animated BMP Graphic LCD Display "8051..... Listed under: [LCD Projects](#)

919.



[BRUSHED MOTOR ESC PIC12F675 PWM](#) Brushed Motor The Microchip 12F675 offers a number of interesting facilities that are used in this design. These facilities permit a much better ESC to be designed than is possible with a 12C5xx PIC, without the complexity of designs... Electronics Projects, Brushed Motor ESC PIC12F675 PWM "microchip projects,..... Listed under: [Motor Projects](#)

920.

[TDA7318 SURROUND SOUND SYSTEM TDA8567Q AMPLIFIER PIC16F628A CONTROL](#) Normally only the hex code with source code projects that are not do not share, but this was an exception different project Surround Sound System, controlled, 2 x 16 LCD display (hue, temperature,



etc..) For me which is remarkable... Electronics Projects, TDA7318 Surround Sound System TDA8567Q Amplifier.....  
Listed under: [Sound - Audio Projects](#)

921.

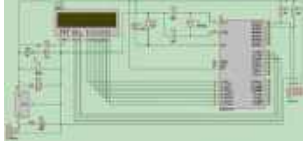

[8051 PS2 KEYBOARD WITH LCD WRITING TEXT](#) PS / 2 protocol used text via a keyboard microcontroller applications that perform printing text on the LCD The goal here Text via keyboard microcontroller to print text on the LCD. Through keyboard microcontroller contained in a code corresponding... Electronics Projects, 8051 PS2 Keyboard with LCD Writing..... Listed under: [LCD Projects](#)

922.



[REMOTE CONTROLLED TOY CAR PROJECT PIC16F877 PIC16F628](#) software CCS used N channel FETs with a 60 amp motor drive circuit and used for different applications control circuit PIC16F877 24c08 eeprom and ICL7660 used CCS EEPROM communication with examples of how you can also control circuit MC33063AP... Electronics Projects, Remote Controlled Toy Car Project PIC16F877..... Listed under: [Car Projects](#)

923.



[PIC18F452 128X64 GRAPHIC LCD ANIMATION EXAMPLE](#) PIC18F452 microcontroller and the proton ide I built using compiler consists of a total of 17 square 128X64 gif animation graphics portrayed on the screen I share my work with you. Gif file using Adobe ImageReady and Photoshop in... Electronics Projects, PIC18F452 128X64 Graphic LCD Animation Example "microchip..... Listed under: [LCD Projects](#)

924.



[HIGH POWER 12V 24V MOTOR SPEED CONTROL CIRCUIT](#) with high power motor control circuit 12 volt and 24 volt motors can be controlled drive circuit is controlled by the microcontroller PIC16F88 12V-24V High-Current Motor Speed Controller Last month, we described the circuit and software features of our... Electronics Projects, High Power 12V 24V Motor Speed..... Listed under: [Motor Projects](#)

925.



[NIMH AND NICAD BATTERIES FAST CHARGER CIRCUIT WITH PIC MICROCONTROLLER](#) 7-30 volts dc voltage control circuit can work with supply LM317T provided with PIC16F88 used for making quick charge. Automatic charging when the battery is full breaking heat protection with thermistor There used IRF540 Mosfet PIC16F88 Fast Charger Circuit... Electronics Projects, NiMH and NiCad Batteries Fast Charger..... Listed under: [Battery Projects](#)

926.



[AT90S2313 COMPUTER SUPPORTED PID TEMPERATURE CONTROLLER](#) PID Temperature Controller Max232 PC via RS232 serial port connection can be made According to information I found PID Temperature Controller is accurate temperature control system i AT90S2313 control system with high mains voltage MOC3061 Opto-isolated TRIAC BTA10-600B used... Electronics Projects, AT90S2313 Computer Supported PID Temperature Controller "avr..... Listed under: [Temperature Measurement Projects](#)

927.

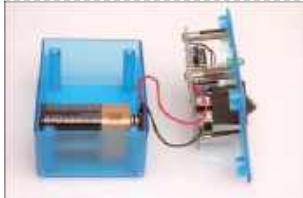

[PIC16F628 MICROCONTROLLER HEART BEAT CONTROL CIRCUIT](#) I understand the circuit with first aid training for use in the designed a kind of electronic heart in training model made with heart massage in the control may be used for a different circuit, especially medical much about... Electronics Projects, PIC16F628 Microcontroller Heart Beat Control Circuit "microchip..... Listed under: [Medical - Health based Projects](#)

928.



[PIC16F88 230V FAN CONTROLLER TIMER CIRCUIT](#) Circuit High Voltage is working with Attention Control circuit supply from the mains without isolation were taken when making connections testing While Be Careful used microcontroller PIC16F88 high voltage to control the triac used BTA08-600TW unfortunately source pic .asm ... Electronics Projects, PIC16F88 230V Fan Controller Timer..... Listed under: [Other Projects](#)

929.



[HAND DRILL BATTERY CHARGE CONTROLLER WITH PIC16F88 MICROCONTROLLER](#) Battery Charge circuit Frequently used in technical service, especially cordless screwdriver, drill bits designed for a charging circuit for the programming, led indicator has a lot of features such as temperature control. Microcontrollers are used in charge control circuit... Electronics Projects, Hand Drill Battery Charge Controller with..... Listed under: [Battery Projects](#)

930.



[REMOTE CONTROLLED SECURITY SYSTEM WITH PIC16F628 PIC16F88](#) Transmitter circuit Specifications Rolling code infrared transmission Small keyfob style case Dual function buttons Randomisation of code parameters feature Synchronising of parameters feature Up to 16 identifications Receiver circuit Specifications 12V operation Up to 16 separate transmitters can be... Electronics Projects, Remote Controlled Security System with PIC16F628..... Listed under: [Security - Safety Projects](#)

931.



[PIC16F88 12V SLA BATTERY CHARGER CIRCUIT](#) PIC16F88 microcontroller used in the circuit description, circuit diagram, pcb asm hex code file there. Able to deliver 60 amps to 10 amps charging current used to charge the batteries temperature control with LED display and so on. includes... Electronics Projects, PIC16F88 12V SLA Battery Charger Circuit "battery..... Listed under: [Battery Projects](#)

932.

[PIC16F628 LC METER CIRCUIT](#) LC meter circuit made with 16F628 microcontroller can be used to measure the inductor and capacitor values. Despite its modest cost, it offers automatic direct digital measurement over a wide range for both capacitance (C) and inductance (L) with... Electronics Projects, PIC16F628 LC meter circuit "microchip projects, microcontroller..... Listed under: [Metering - Instrument Projects](#)





933. [PIC16F88 RF REMOTE 433MHZ TRANSCEIVER SWITCHES](#) RF communication system operating with a switching circuit controlled by the water pump 1000 watts of project files are all sources. if you want to switch devices rated over 1000W or control water pumps, then you need the UHF... Electronics Projects, PIC16F88 RF Remote 433MHz Transceiver Switches "microchip..... Listed under: [Other Projects](#)



934. [TWO-CHANNEL DIMMER CIRCUIT WITH PIC16F84A LED LEVEL INDICATOR](#) High power lamp control Maximum lamp brightness preset Minimum lamp brightness preset for filament preheating Automatic or manual dimming between brightness presets Separate flash on and flash off Flash brightness preset Dimming rate programmable from instant through to 40... Electronics Projects, Two-Channel Dimmer Circuit with PIC16F84A LED..... Listed under: [LED Projects](#)



935. [PIC16F88 TACHOMETER CIRCUIT LED AND DISPLAY INDICATOR](#) Tachometer circuit 12v dc supply voltage LEDs used for the supply of silicon chip MC34063 LM2940 applications for the pic 16ff88 Switched likes to use power resources A gear shift light and a rev limiter output are standard features... Electronics Projects, PIC16F88 Tachometer Circuit LED and Display..... Listed under: [Metering - Instrument Projects](#)

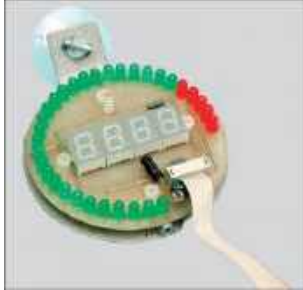

936. [PIC16F84 KING RIDER CIRCUIT](#) king rider led effect circuit pic 16f84 and LM358 based on LEDs burning speed and brightness 50k potentiometer with ayarlanabiyi the "Pattern select" but with the different operating modes can only be undertaken drive transistor bc328 circuit supply voltage... Electronics Projects, PIC16F84 king rider circuit "led projects, microchip..... Listed under: [Development Board - Kits Projects](#)

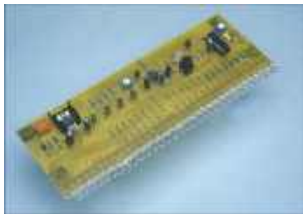

937. [CNC PCB MACHINE PROJECT](#) CNC Project of the information provided on PCB drilling machine, CNC benefits do not, is bound to be thanks to those who contributed Maximus – CNC PCB Drilling Machine This web page is designed to present my graduation thesis;... Electronics Projects, CNC PCB Machine Project "microchip projects, microcontroller..... Listed under: [CNC Machines Projects](#)



938. [8051 ROBOT ARM STEPPER MOTOR CONTROL](#) In this 8051 Robot ARM application I use for robot arm 3 stepper motor design, study and is to be informed about the expulsion. Stepping motors to provide work, applied to the ends of the half step mode and... Electronics Projects, 8051 Robot ARM Stepper Motor Control "avr..... Listed under: [Robotics - Automation Projects](#)

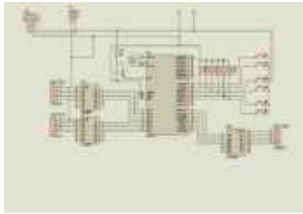

939. [8051 ELEVATOR PROJECT STEPPER MOTOR CONTROL](#) This application step (step) motor control, input and output ports through 8051 will examine the circuit by providing lift. We use our stepper motor circuit. As we know, certain steps of the stepper motor, moving the appropriate signals are... Electronics Projects, 8051 Elevator Project Stepper Motor Control "avr..... Listed under: [Motor Projects](#)

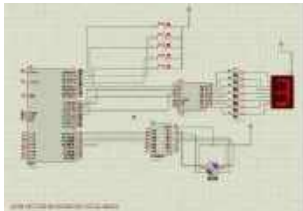

940. [AT89C51 L293D MOTOR CONTROL PROJECT](#) AT89C51 L293D Motor Control Circuit Operation, Our project name and the name suggests, the treadmill is the motor control is required. When designing this project, I saw fit to use DC motors. Because the use of DC motors and... Electronics Projects, AT89C51 L293D Motor Control Project "avr..... Listed under: [Motor Projects](#)

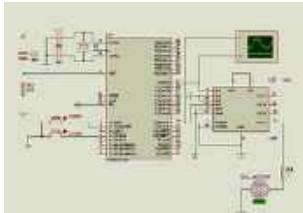

941. [PIC16F876 PWM FAN SPEED CONTROL](#) PIC16F876 with PWM applications can be an example of a project 9 fans can be controlled 3 BUZ72 Mosfet with the PIC outputs reinforced LM60 temperature sensor information from the relative speed is changing the R and G LEDs... Electronics Projects, PIC16F876 PWM Fan Speed Control "microchip projects,..... Listed under: [Other Projects](#)

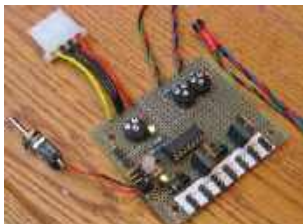



942. [PIC16F827 REMOTE CONTROLLED RGB LIGHT BULBS LAMP PROJECT](#) Previously PIC16F628 and a similar share had been made in this project is more or less there used microcontroller pic16f627 3 pieces 220v 40w 60w can be used MOC3020 Optodiyak isolation from the provided pic Supply 6 volt transformer... Electronics Projects, PIC16F827 Remote Controlled RGB Light Bulbs..... Listed under: [Home Automation Projects](#)



943. [TSA5511 5W PLL FM TRANSMITTER PIC16F627A](#) Asm hex file schema PCBs have been described as illustrated winding supply voltage and transistor used varies according to the strength values given between 1 .7 watts. PLL FM Transmitter Circuit The transmitter includes RDS -SCA input and Audio ... Electronics Projects, TSA5511 5W PLL FM Transmitter PIC16F627A " microchip..... Listed under: [Metering - Instrument Projects](#)

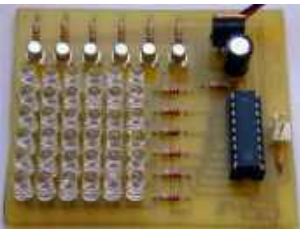
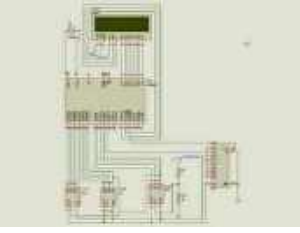
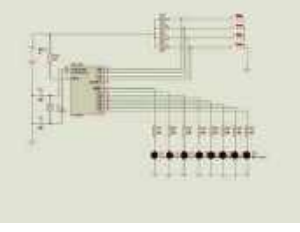
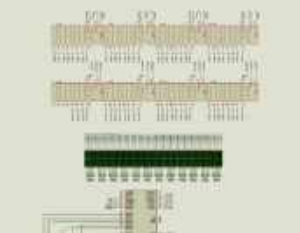
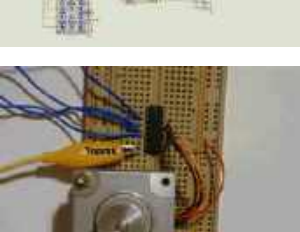
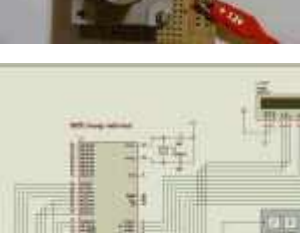

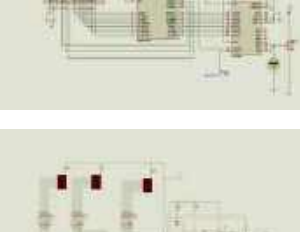
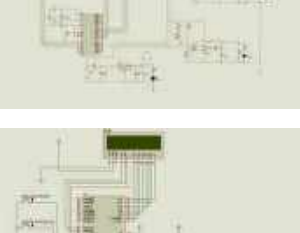
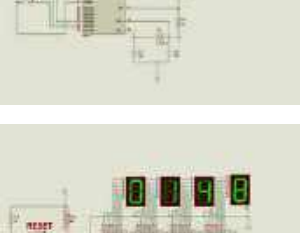
944.  [PIC16F628 PICBASIC PRO 36 LCD LED MATRIX](#) Without the use of ready-made modules connected in parallel circuit pic 16F628 36 leds for power output will not be sufficient 2N2222A NPN transistor output circuits powered by regulated the supply of L7805 is provided by In addition to... Electronics Projects, PIC16F628 PICBASIC PRO 36 LCD led..... Listed under: [LED Projects](#)
- 
945.  [AT89C51 LCD DISPLAY FREQUENCYMETER PROJECT](#) Frequency in all matters relating to the definition based on frequency is required. In the same way the numeric (digital) Frequency frequency to do the same as the description of the circuit should be implemented. Frequency: 1 frequency is... Electronics Projects, AT89C51 LCD display Frequencymeter Project "8051 example,..... Listed under: [LCD Projects](#)
- 
946.  [PIC16F84A FOUR PROGRAMMED LED ANIMATION CIRCUIT](#) Used microcontroller PIC16F84A four different study program on 8 leds switch is turned off, the program begins to work every key LEDs in different ways combustion provides all the source files proteus isis simulation. DSN ares pcb. LYT PicBasic.... Electronics Projects, PIC16F84A Four Programmed LED Animation Circuit "led..... Listed under: [LED Projects](#)
- 
947.  [AT89C51 KEYPAD CONTROLLED SCROLLING LED DOT MATRIX TEXT](#) AT89C51 Scrolling LED Circuit Operation: Keypad't the values entered the program through is continually monitored, "\*" key is pressed unless the display of the first letter that section required all letters appear, but the desired letter or number after... Electronics Projects, AT89C51 Keypad Controlled Scrolling LED Dot..... Listed under: [LED Projects](#)
- 
948.  [AT89S52 LCD DISPLAY STEPPER MOTOR CONTROL EXAMPLE](#) AT89S52 Stepper Motor Control Stepper motor, the motor angular position is changing in steps. This engine is moving into specific steps, according to the windings is controlled by sending signals. Any stimulus that would make my motor movement, the... Electronics Projects, AT89S52 LCD Display Stepper Motor Control..... Listed under: [Motor Projects](#)
- 
949.  [8051 CALCULATOR CIRCUIT](#) 8051 Calculator Circuit Operation As seen at half one has to use the keypad and an LCD with 8051. The keypad consists of rows and columns. When the button is pressed certain keys combined treatment. Pressing 1, column 1... Electronics Projects, 8051 Calculator Circuit "8051 example, avr project,..... Listed under: [Calculator Projects](#)
- 
950.  [FOR CAR LED NEON CIRCUITS](#) 2 Application There pic16f626 application with PWM and LED lasts probably a variety of effects there proteusd the need to try the other simple series-connected LEDs and for limiting resistance is made up of various colors (blue LEDs, green... Electronics Projects, For Car Led Neon Circuits "led projects,..... Listed under: [LED Projects](#)
- 
951.  [8051 ADC0808 LCD DISPLAY VOLTMETER](#) ADC0808 analog / digital converter of the 8 analog inputs (IN0-IN7) and 8-bit digital output (OUT0-OUT7) are available. Entries will be transferred to the digital output of the converter which converted to 3-bit ADD, ADD B, and C address... Electronics Projects, 8051 ADC0808 Lcd Display Voltmeter "8051 example,..... Listed under: [LCD Projects](#)
- 
952.  [LED DISPLAY SPEED METER CIRCUIT WITH AT89C51](#) Speed Meter Circuit consists of four parts. These Supply solid floor Sensor sensor, microcontroller and microcontroller solid hexadecimal numbers we obtained from the 7-segment display technology with time code converter solid. Program Keil  $\mu$ Vision3 AT89C51 microcontroller. Supply DC 12V... Electronics Projects, LED Display Speed Meter Circuit with..... Listed under: [Metering - Instrument Projects](#)
- 
953.  [8051 STOPWATCH CIRCUIT WITH LCD DISPLAY](#) Stopwatch Circuit 8051 on behalf of the programming of integrated compiler program that is used too much in the present case. You are left with only the easiest to use and most advantageous for you to choose. 8051, which... Electronics Projects, 8051 Stopwatch Circuit with Lcd Display "8051..... Listed under: [LCD Projects](#)
- 
954.  [0-9999 COUNTER CIRCUIT WITH PIC16F84A PICBASIC PRO](#) This Counter Circuit and the microcontoller 7-segment display using PIC16F84A 0-9999 counter circuit is formed. Plus (+) button to increase counter value minus (-) button allows the reduction. RESET button will reset the value in the counter. 0-9999 Counter... Electronics Projects, 0-9999 Counter Circuit with PIC16F84A Picbasic..... Listed under: [Phone Projects](#)
- 
955. [LCD DISPLAY FAN CONTROL CIRCUIT PIC16F84A PICBASIC PRO](#) This circuit and the microcontroller PIC16F84A DS18B20 temperature information is obtained using the temperature sensor. 16X2 LCD screen showing temperature information obtained from user-specified temperature is exceeded audible warning. The ambient temperature value drops to the desired level of... Electronics Projects, LCD Display Fan Control..... Listed under: [LCD Projects](#)



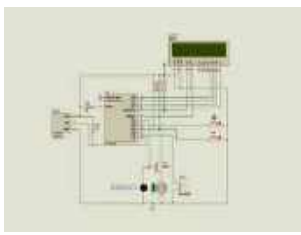

956. [PIC16F84 LCD DISPLAY LC METER](#) PIC16F84 LCD Display LC Meter circuit Box front waisted measure be careful when buying the box to cut the picture box paste it on top and falçata or drawing a knife then stop in the box bourdu to keep... Electronics Projects, PIC16F84 LCD Display LC Meter "microchip projects,..... Listed under: [LCD Projects](#)



957. [PIC16F84 MULTI SIREN SOUNDS CIRCUIT](#) 16 different alarm sound circuit, after running the simulation of the fourth line of dip switches in different positions can run by selecting the  $4 \times 4 = 16$  different sound Remember to press the reset button at the... Electronics Projects, PIC16F84 Multi Siren Sounds Circuit "microchip projects,..... Listed under: [Sound - Audio Projects](#)



958. [CENTRAL SECURITY SYSTEM WITH PIC16F877](#) Circuit Operation: PIC16F877 used in the circuit of the B and D as input port is selected. 8 of these units with port B doors, windows and etc.. from places logic 1 or 0 state is evaluated. D port... Electronics Projects, Central Security System with pic16f877 "microchip projects,..... Listed under: [Security - Safety Projects](#)



959. [LM35 SENSOR HEATER CONTROL PIC16F877 THERMOMETER](#) In this project using PIC16F877 microcontroller integrated temperature-controlled thermometer did. Thermometer for the implementation of PIC 16F877 / D converter property was utilized. Half-output unit, the LCD screen is used. But the main feature of the application in a ... Electronics Projects, LM35 Sensor Heater Control PIC16F877 Thermometer " microchip projects, microcontroller..... Listed under: [Sensor - Transducer - Detector Projects](#)



960. [C LANGUAGE COMPUTER AND ELECTRONIC CIRCUIT CONTROL](#) C language dealing with the business of the electronic to the floor to people who want to be your source for inspiration can take most of the projects in the program, the source of the C / C +... Electronics Projects, C Language Computer and Electronic Circuit..... Listed under: [Other Projects](#)



961. [PIC16F84 MICROCONTROLLER VIDEO GAME CIRCUIT \(TETRIS, PONG\)](#) Made a beautiful project with PIC16F84, both in video and joystick control provided by a single processor OrCAD program prepared by pcb schematic and pic assembly .asm, hex code It has been designed hardware of the system's CIP game... Electronics Projects, PIC16F84 Microcontroller Video Game Circuit (tetris,..... Listed under: [Game - Entertainment Projects](#)



962. [PIC16F628 WI-FI ROBOT PROJECT](#) Interesting and a bit costly robot project control programs and Visual Basic 6 source code shared PIC16F628 asm and other C hex code given project is not able on your details or Visual Basic programs work for you, knows... Electronics Projects, PIC16F628 Wi-Fi Robot Project "microchip projects, microcontroller..... Listed under: [Robotics - Automation Projects](#)



963. [PIC16F84 2.7GHZ FREQUENCY METER CIRCUIT 100KHZ RESOLUTION PICBASIC PRO](#) Frequency meter PIC16F84 with prescaler This small unpretentious frequency is for SHF measures up to 2.7 GHz for which we do not look great precision (eg ATV). Like many circuits of this kind, it is based on the AN592... Electronics Projects, PIC16F84 2.7GHz Frequency Meter Circuit 100kHz..... Listed under: [Metering - Instrument Projects](#)



964. [MC9S08QG8 MICROCONTROLLER PROJECT WITH A BLUETOOTH-CONTROLLED ROBOT](#) Side-plate is used mainly to connect a Bluetooth module and the robot is without a fully functional, but it is not possible to wirelessly control.Mechanical construction is due to the use of the Best work very simple. The body... Electronics Projects, MC9S08QG8 Microcontroller Project with a Bluetooth-Controlled..... Listed under: [Bluetooth Projects](#)









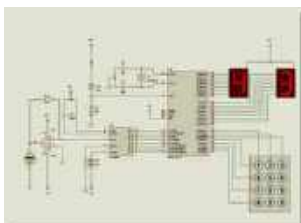



965. [PIC16F628 LCD DISPLAY THERMOMETER CIRCUIT \(DATE TIME\)](#) LCD Display LCD display thermometer circuit have all the source files ares proteus simulation and PicBasic PRO source code files and proteus isis simulation proteus ares pcb files and other software Circuit Diagram and finished photos LCD Display Thermometer... Electronics Projects, PIC16F628 LCD Display Thermometer Circuit (date..... Listed under: [LCD Projects](#)







966. [8051 PROGRAMMABLE POWER SUPPLY](#) Circuit Operation: Circuit diagram appears in the 0-5 the entered value from the keypad circuit, which is connected to port P1 applied to the integrated DAC 0808 DAC output is obtained from the analog voltage. P0 port is connected... Electronics Projects, 8051 Programmable Power Supply "8051 example, avr..... Listed under: [Microcontroller Programmer Projects](#)





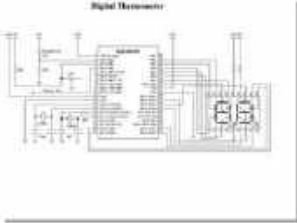
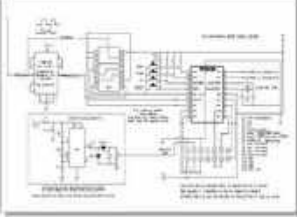
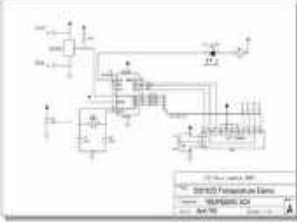

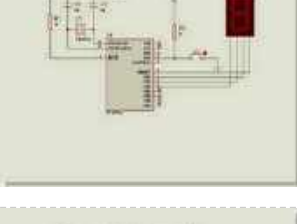



967. [AT89S52 DS1620 THERMOMETER CIRCUIT \(LCD DISPLAY\)](#) This project gave ds1620'n given as a result of the digitally using AT89S52 microcontroller is a graphic display of temperature information of the LCD screen. Moreover, the circuit ambient temperature when it reaches a



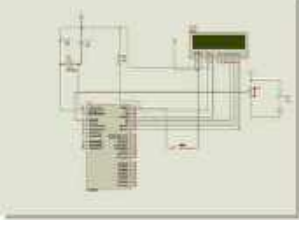
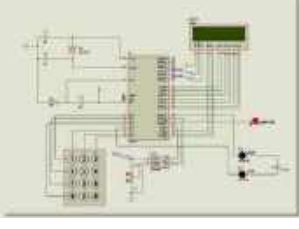
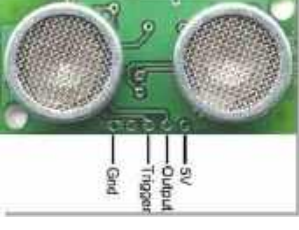



- temperature above 250C is no ... Electronics Projects, AT89S52 DS1620 Thermometer Circuit (LCD Display) " 8051.....  
Listed under: [LCD Projects](#)
- 
968.  [PICMICRO THE SERVO MOTOR SERIAL PORT CONTROL PROJECT](#) PIC16F877 pic16f876 via the serial port and control the servo motor with 8 additional program code in addition have prepared for the test sample c language To follow this project need to arm themselves demoboard 16F876 (or 16f877), the... Electronics Projects, PICmicro the Servo Motor Serial Port..... Listed under: [Motor Projects](#)
- 
969.  [EXAMPLE VISUAL BASIC RS232 RF COMMUNICATION PIC16F84](#) PC serial port (RS232) with the RF transceiver and electronic circuits PIC16F84 controlled, etc. can be an example for the exchange of data between All the resources are there vb6 source code. Exe. Frm. VLPs. VBW file data circuit... Electronics Projects, Example Visual Basic RS232 RF Communication..... Listed under: [Other Projects](#)
- 
970.  [PIC16F84 LED DISPLAY FREQUENCY COUNTER CIRCUIT](#) LED 6 digit display for rig frequency counter -Just as it may seem at frequency display of rig, and produced a dot LED-PD4435 counter, and make use of this in the future, and that the "sold out, there is... Electronics Projects, PIC16F84 LED Display Frequency Counter Circuit "microchip..... Listed under: [LED Projects](#)
- 
971.  [INDUCTANCE & CAPACITANCE METER PIC16F648A LCMETER](#) PIC16F648A LC meter Simply, + -1% accuracy battery powered compact LC for low power consumption does not have a meter is recommended. C measurement range is 0.1pF ~ 1uF (renewal auto range) L range is measured 0.01uH ~ 100mH... Electronics Projects, Inductance & Capacitance Meter PIC16F648A LCMeter "microchip..... Listed under: [Metering - Instrument Projects](#)
- 
972.  [PIC16F88 DIGITAL VOLTMETER CIRCUIT](#) Voltmeter circuit PIC16F88 microcontroller C language prepared by the program based on the indicators used for the 7-segment LED display with integrated TTL 74ls47 74hc238 and are driven. pic16F88 of AD was made using a digital voltmeter conversion. The... Electronics Projects, PIC16F88 Digital Voltmeter Circuit "microchip projects, microcontroller..... Listed under: [Metering - Instrument Projects](#)
- 
973.  [GRAPHIC LCD MODULE LIBRARY FOR SG12864AS CCS C COMPILER](#) Graphic LCD Module Library 2.0 CCS C This has created a dedicated library and font control.PIC so as not to create a library Tetsuya Gokan famous, I'd be with you This library has been included in the PIC16 SG12864... Electronics Projects, Graphic LCD Module Library for SG12864AS..... Listed under: [LCD Projects](#)
- 
974.  [SIMPLE ELECTRONIC PIANO WITH PIC16F84A](#) The PIC has a white arrow in the transistor and the clock is a little to the right. Pull-down resistor Tact switches are in line with the lower back. PIC fast 200ns port in the meantime and have pressed... Electronics Projects, Simple Electronic Piano with PIC16F84A "microchip projects,..... Listed under: [Sound - Audio Projects](#)
- 
975.  [SIMPLE MELODY CIRCUIT WITH PIC16F84A DO-RE-MI-FA](#) PIC16F84A microcontroller with the basic DO-RE-MI-FA pic of a simple circuit that can produce notes prepared by software RA3 assembly speaker connected to the output of 0.5W. Guide to use the PIC electronic work, I made a Doremifa organ... Electronics Projects, Simple Melody Circuit with PIC16F84A DO-RE-MI-FA "microchip..... Listed under: [Sound - Audio Projects](#)
- 
976.  [PIC16F84 LINE FOLLOWER ROBOT PROJECT](#) Line following robot is the thing to run on the line by controlling the motor of the left and right detected by light, such as infrared drawn in black (7m / m width or so) line. As illuminating the... Electronics Projects, PIC16F84 Line Follower Robot Project "microchip projects,..... Listed under: [Robotics - Automation Projects](#)
- 
977.  [PIC16F84 SIMPLE PICMICRO WEB SERVER](#) I'm curious and I want to try a project with the web server 16f84 project has two circuits in series and parallel port connection and circuit eeprom 24c256 used pic and communication can be pic assembly examples PIC16F84... Electronics Projects, PIC16F84 Simple PICmicro Web Server "microchip projects,..... Listed under: [Internet - Ethernet - LAN Projects](#)
- 
978.  [PIC16F628 MULTI-MODE ENCODER, COUNTER CIRCUITS CCS C](#) Hello friends, I have done well to share with you the counter circuits as functions istedim.kisa tell. There are three mode of counter: enc: millimeter accuracy in the measurement is made. The value is set in the output data.... Electronics Projects, PIC16F628 Multi-Mode Encoder, Counter Circuits CCS..... Listed under: [Other Projects](#)
- 
979. [PIC16F84 DS1920 SCROLLING TEMPERATURE DISPLAY MAX7219 CCS C](#) Pic16f84 LED display with temperature measuring software compiled with CCS C Scrolling Temperature Display. -55 – 100C (-67 – 212F) range 4 digit LED display compile-time animation options This project shows





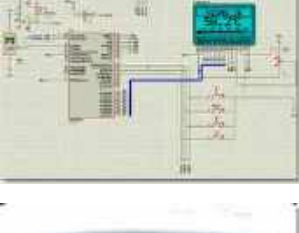

- a temperature readout on a 4-digit LED display.... Electronics Projects, PIC16F84 DS1920 Scrolling Temperature Display MAX7219..... Listed under: [Temperature Measurement Projects](#)
- 
980.  [PIC16C74 NTC THERMOMETER CIRCUIT](#) A simple thermometer circuit display used to display the value of the temperature sensing for 10 k ntc also relay output the relay can be backed by sustained with the transistor has very little material can be accomplished with... Electronics Projects, PIC16C74 NTC Thermometer Circuit "microchip projects, microcontroller..... Listed under: [Metering - Instrument Projects](#)
- 
981.  [PIC16C84 PICMICRO CONTROLLED CAPACITANCE METER CIRCUIT](#) PIC16C84 and with other integrated circuits (74HC390, 4011, NE555) measuring devices with micro-controller can be an example to people who want to design pcb files available asm the schema The Capacitance Meter has 4 ranges. In Manual Mode each... Electronics Projects, PIC16C84 PICmicro Controlled Capacitance Meter Circuit "microchip..... Listed under: [Metering - Instrument Projects](#)
- 
982.  [PIC16C74 EMBEDDED 10BASET ETHERNET CS8900](#) Embedded ethernet enables microcontroller based projects to send and receive packets over the network. The board shown on the left is actual size and incorporates all the circuitry needed to enable 10BaseT communications. The board is designed to minimize... Electronics Projects, PIC16C74 Embedded 10BaseT Ethernet CS8900 "microchip projects,..... Listed under: [Internet - Ethernet - LAN Projects](#)
- 
983.  [DS1820 TEMPERATURE SENSOR CIRCUIT PIC16F84 ASSEMBLY](#) DS1820 sensor designed for use with assembly language PIC16F84 on a circuit board data is displayed via 2 x 16 LCD mlab working on the code you can see step by step. cod file, including all source code available... Electronics Projects, DS1820 Temperature Sensor Circuit PIC16F84 Assembly "microchip..... Listed under: [Temperature Measurement Projects](#)
- 
984.  [ADXL05 DIGITAL INCLINOMETER CIRCUIT PIC16F84](#) microchip pic 16f84 how different circuits have been with. Display indicators that could measure the angle of inclination sensor information received through a circuit ADXL05 and 74HC164 microcontroller is displayed on the 7 segment display with PIC assembly language... Electronics Projects, ADXL05 Digital Inclinometer Circuit PIC16F84 "microchip projects,..... Listed under: [Metering - Instrument Projects](#)
- 
985.  [CAR THERMOMETER PROJECT PICBASIC PRO DS18B20 PIC16F628](#) PIC16F628 DS18B20 thermometer circuit that you can use in your car, inside and outside temperature thermometer circuit is a circuit that shows up on the LCD isis proteus ares pcb and simulation software available in source and hex pbp... Electronics Projects, Car Thermometer Project PicBasic Pro DS18B20..... Listed under: [Metering - Instrument Projects](#)
- 
986.  [PIC16F877 LCD MOTORS SPEED INDICATOR ENCODER CIRCUIT](#) PIC16F877 microcontroller with LCD also shows the engine speed encoder circuit. These and the interrupt routine of the main program flow chart is a flow chart. PORT in the main program and is defined PORTB aspects. Then the program... Electronics Projects, PIC16F877 LCD Motors Speed Indicator Encoder..... Listed under: [LCD Projects](#)
- 
987.  [MICROCONTROLLER CONTROLLED METAL DETECTOR CIRCUITS OVER 1M](#) Detailed descriptions of circuit diagram pcb layout asm hex file with a list of materials is controlled by the metal detector PIC16C84 microcontroller circuit Metal detectors and other integrated circuits used in the TL072, lcm7555, LMC7660, LM318, 4066 There... Electronics Projects, Microcontroller Controlled Metal Detector Circuits Over..... Listed under: [Other Projects](#)
- 
988.  [WITH BUTTON CONTROL CCS C CIRCUIT LCD DISPLAY PIC16F877](#) CCS-C code that prepare "@ fxdev" a project done on request circuit up and down the third button 2 buttons to control the direction of the desired output number appears on the LCD[clear][clear] screen when the output of the... Electronics Projects, With Button Control CCS C Circuit..... Listed under: [LCD Projects](#)
- 
989.  [HEXADECIMAL, BINARY COUNTER CIRCUITS LED DISPLAY PIC16F84](#) Hexadecimal and binary counter display LED display applications have been realized with all circuits PIC16F84A isis simulation code and other files are MPLAB Hex-button controlled adesimal Counter 1-2-3-4-5-6-7-8-9-cross count ABCDEF. Dip switches controlled display hexadecimal display counter circuit based... Electronics Projects, Hexadecimal, Binary Counter Circuits LED Display..... Listed under: [LED Projects](#)
- 
990.  [FEEDBACK PWM MOTOR CONTROL CIRCUIT WITH PIC16F628 L298](#) Circuit L298 (bridge-mounted motor drive) and PIC16F628 microcontroller based on the stop, sudden stop, start, improve, finish, forward, rewind controls have brake position the motor generator to the state in case of falling energy battery again sending software in... Electronics Projects, Feedback PWM Motor Control Circuit with..... Listed under: [Motor Projects](#)

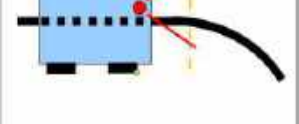
991.  [COLOR SENSE CIRCUIT LCD PIC16F877 PICBASIC PRO](#) This circuit using a PIC 16F877 microcontroller LCD (Liquid Crystal Display) has been applied on the color sensor. For circuit design and printed circuit board operations and Proteus ISIS Proteus ARES program is used. The operating logic circuits in ... Electronics Projects, Color Sense Circuit LCD PIC16F877 Picbasic Pro " microchip..... Listed under: [LCD Projects](#)
992.  [PIC18F452 CCS C RF HUMIDITY TEMPERATURE CIRCUIT \(ADDITION TO CALENDAR, CLOCK\)](#) Feature a very high level transmitter and receiver circuit consists of two parts of a project are provided with the main control PIC18F452 PIC16F84 sensors are connected to the transmitter circuit based on the information received from sensors on... Electronics Projects, PIC18F452 CCS C RF Humidity Temperature..... Listed under: [Temperature Measurement Projects](#)
993.  [PIC16F876 MIDI SPLITTER CIRCUIT WITH LCD DISPLAY](#) Circuit pic16f876 microcontroller and SN74LS00 NAND gate integrated based on the midi input CNY17 opto Kubla with disabled insulated isolated single midi signal 2 as output enlarge able 2 × 16 LCD screen on the selected channel information can... Electronics Projects, PIC16F876 Midi splitter Circuit with LCD..... Listed under: [LCD Projects](#)
994.  [PIC18F452 INFRARED RADAR CIRCUIT GP2D120 SENSOR](#) Led indicator circuit short-range radar sensor that is used gp2d120 sharp pic 18f452 microcontroller software in C language Hi-Tech c with LEDs 74HCT373 integrated infrared sensor with pic GP2D120 a good example to use .. Sharp GP-2D120 features •... Electronics Projects, PIC18F452 Infrared Radar Circuit GP2D120 Sensor "hi..... Listed under: [Sensor - Transducer - Detector Projects](#)
995.  [PIC16F877 ADJUSTABLE DIGITAL POWER SUPPLY CIRCUIT](#) All details can be adjusted with a microcontroller controlled digital power supply project volts and amps values can be read on the LCD pcb box design 3-dimensional views of the c language prepared by the powder-magazine's source software projects... Electronics Projects, PIC16F877 Adjustable Digital Power Supply Circuit "microchip..... Listed under: [power - energy projects](#)
996.  [MICROCONTROLLER CONTROLLED LCD SCREEN BATTERY CHARGING CIRCUIT PICBASIC PRO](#) battery charging circuit is carried out with the software PIC16F877 prepared with PicBasic Pro 2 × 16 LCD display isis simulation can be observed on the charge status and resources are PbPr asm hex file. Thanks to those who... Electronics Projects, Microcontroller Controlled LCD Screen Battery Charging..... Listed under: [Battery Projects](#)
997.  [ADC0831 8051 LM35 TEMPERATURE CONTROL WITH LCD SCREEN](#) Adc 0831 with 8051 lm 35 temperature sensor, and a detailed project examples for the use of inverters. author :Özer Deniz Objective: LM 35 temperature sensor dealt with 0831 ADC analog-to-digital conversion of knowledge, and expression of this information... Electronics Projects, ADC0831 8051 LM35 Temperature Control with..... Listed under: [Temperature Measurement Projects](#)
998.  [8051 SRF04 ULTRASONIC DISTANCE METER CIRCUIT](#) 8051 srf04 ultrasonic distance measurement application also contains information about the different controllers and this information can be useful for applications 8051 microcontroller distance measurement using ultrasonic transceiver done. Studies, using microcontrollers 8051 with the help of ultrasonic distance... Electronics Projects, 8051 SRF04 Ultrasonic Distance Meter Circuit "avr..... Listed under: [Metering - Instrument Projects](#)
999.  [AUDIO SIGNAL MEASUREMENT DIGITAL MILLIVOLTS METER CIRCUIT PIC16F88](#) Millivolts meter circuit PIC16F88 based on 2 × 16 LCD display there mV, DBV, dBm signal levels can show audio signal input section ad623 and ad8307 used 12-15volt DC adapter operated on supply input LM317 regulated with built pic... Electronics Projects, Audio Signal Measurement Digital Millivolts Meter..... Listed under: [Metering - Instrument Projects](#)
1000.  [PIC16F877 STEPPER MOTOR DRIVER CIRCUIT CCS C](#) stepper motor drive circuit diagram ccs c code hex "check-16F877 pic stepper-motor control can be made back and forth provided with 2 × 16 LCD 12volt driver steps on the screen you can see the details bc548 transistors used... Electronics Projects, PIC16F877 Stepper Motor Driver Circuit CCS..... Listed under: [Motor Projects](#)
1001.  [CAR FUEL MONITOR CIRCUIT PIC16F84](#) Indicators based on circuit pic 16f84 2 × 20 character LCD display hitah lm032 arrrntil xmb1 as the car's fuel status displays on the LCD display shows a digital fuel can be said asseblly prepared with software source files... Electronics Projects, Car Fuel Monitor Circuit PIC16F84 "microchip projects,..... Listed under: [Metering - Instrument Projects](#)
1002.  [FREE MICROCHIP PICMICRO OF COMPLETED PROJECTS](#) Magazine EPE (Everyday Practical Electronics Magazine) shared for free on the site I came across a pic of all the details on the project (English)'s many projects with source code PICmicro Completed Projects List Magick Musick ( 2xpic16f84,tlc7524,lm358,lm13600,i202 Video... Electronics Projects, Free Microchip PICmicro of Completed Projects "microchip..... Listed under: [Microcontroller Programmer Projects](#)

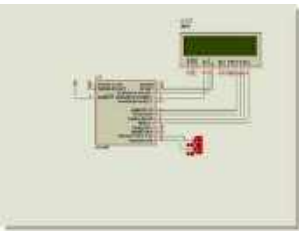

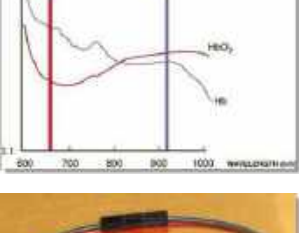
1003.  [CCS C SUMO ROBOT PROJECT PIC16F876](#) Design a perfectly good sumo robot design and control circuit pic 16f876 based on the motor drive lm293d drizzle detection for the sharp gp2d12 sensors used hardware and software in detail about (english) Information Additional file given in (... Electronics Projects, CCS C Sumo Robot Project PIC16F876 "ccs..... Listed under: [Robotics - Automation Projects](#)
- 
1004.  [PIC24F SD CARD READER CIRCUIT IMAGE FRAME NOKIA 6100 LCD](#) An interesting project you know, this sort sd card input 7 inch image viewer (photo frame) fashion PIC24FJ64GA002 and nokia lcd using the mini image viewer made software c language yl crafted 16-bit dsPIC with alıks for people who... Electronics Projects, PIC24F SD Card Reader Circuit Image..... Listed under: [Phone Projects](#)
- 
1005.  [PIC18F2550 USB ISOLATED TRIAC CONTROL CCS C VISUAL BASIC](#) Now you have to wonder to advanced pic controller was quite popular among them PIC18F2550 USB pic18f2520 a good example on how to control the output with the MOC3042 opto triac driver output isolation is being provided and TIC236M... Electronics Projects, PIC18F2550 USB isolated Triac Control CCS..... Listed under: [Interfacing\(USB - RS232 - I2c -ISP\) Projects](#)
- 
1006.  [COMPUTER CONTROLLED HOME AUTOMATION CIRCUIT PIC16F877 CCS C VISUAL BASIC](#) Basic home automation project can be an example with all the resources INFINITY side @ picproj on the forums shared software ccs-c prepared by the source. C. H ccsc codes isis simulation files and visual basic interface of the... Electronics Projects, Computer Controlled Home Automation Circuit PIC16F877..... Listed under: [Home Automation Projects](#)
- 
1007.  [COMPUTER-CONTROLLED PROGRAMMABLE RGB LED DRIVER PIC16F628 PWM](#) An interesting project computer-aided olmasida a very good feature. Supervision can be said that the RGB PWM circuit PIC16F628 dali assembly prepared with software installed on the RGB data while sending the program's visual basic code through a source-based... Electronics Projects, Computer-Controlled Programmable RGB LED Driver PIC16F628..... Listed under: [LED Projects](#)
- 
1008.  [PIC C18 CCS C USB APPLICATIONS PIC18F4550 PIC18F2550 CIRCUITS](#) Previously prepared by @Ahmet ATA `s" Step by Step USB and Applications "share the work I did from the most comprehensive Turkish source USB PIC think about communication. Of electro-techno forum "to tmco" very nice continuation of this project,... Electronics Projects, PIC C18 CCS C USB Applications..... Listed under: [Interfacing\(USB - RS232 - I2c -ISP\) Projects](#)
- 
1009.  [LM35 PIC16F877 TEMPERATURE MEASUREMENT AND GRAPHIC LCD MENU DESIGN](#) These circuits using CCS C Compiler and use of LM35 temperature sensor includes menu design on Graphic LCD. Menu selection, etc., especially on graphic LCD. one of the rare examples of issues on the Internet. (I call this menu... Electronics Projects, LM35 PIC16F877 Temperature Measurement and Graphic..... Listed under: [Temperature Measurement Projects](#)
- 
1010.  [PICMICRO LED TACHOMETER CIRCUIT](#) Handmade pretty stylish LED display digital speedometer tacho meters. Source or assembly code pic16f874 PIC16F877 can be done with the circuit and wiring diagrams directly from the preparation given the 33-hole leds pcb layout on a plaque made analog... Electronics Projects, PICmicro LED tachometer Circuit "led projects, microchip..... Listed under: [LED Projects](#)
- 
1011.  [HI TECH C LCD EXAMPLES PIC18F452, PIC16F877](#) Software Hi-Tech C language prepared by the various applications of electronic sections PIC18F452 PIC16F877 PIC18F4550 based on the Hi Tech C source code and the PCB drawings and all other documents have been shared, LCD character graphics used for... Electronics Projects, Hi Tech C LCD Examples PIC18F452,..... Listed under: [LCD Projects](#)
- 
1012.  [SAAA1057 BH1417 15W FM STEREO MULTIPLEX PIC16S819 CONTROL](#) Stereo Multiplexing for FM circuit pic16f819 saa1057 bh1417 integrated based on the basic prepared with source software's (. Bas) circuit diagrams and material list has pcb drawing no different practice pic microcontroller with PLL FM applications for a sample... Electronics Projects, SAAA1057 BH1417 15W FM Stereo Multiplex..... Listed under: [Sound - Audio Projects](#)
- 
1013.  [NEGATIVE DELTA-V BATTERY CHARGING CIRCUIT LCD DISPLAY PIC16F876](#) Previously published as automatic charging system is the advanced version of my project I designed a new system using the 16F876. Without much change in the electronic portion of the system say the changes made in the program. I... Electronics Projects, Negative Delta-V Battery Charging Circuit LCD..... Listed under: [Battery Projects](#)
- 
1014.  [PIC16F877 LINE FOLLOWING ROBOTS PROJECT](#) Line following robots are still extremely popular line following robot someone finally do something different on the various source code and shared with the project. The robot's camera (webcam) for part of the CPP written with the program's control... Electronics Projects, PIC16F877 Line following robots Project "microchip projects,..... Listed under: [Robotics - Automation Projects](#)

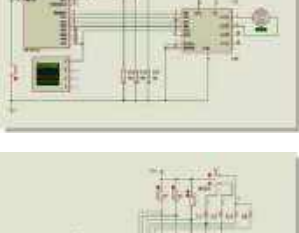
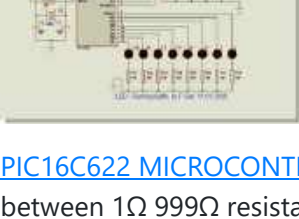
1015.  [PICMICRO LCD BAR APPLICATIONS HI TECH C AND PROTON IDE EXAMPLE](#) Greetings friends I share the LCD bar applications with C spelled my earlier application with basic proton HiTech C and I've taken this time. In case that codes for functions can easily be adapted to the application. In addition,... Electronics Projects, PICMicro LCD Bar Applications Hi Tech..... Listed under: [LCD Projects](#)
1016.  [PICMICRO PIC16C923 CURRENT MEASUREMENTS WATT HOUR METER PROJECT](#) Current measurement circuit based on the PIC16C923 and CS5460 integrated 120V or 220V, 50Hz, 60Hz. voltage in the frequency range can measure's LCD display and control buttons Current measurements used in the current transformer substation is being processed on... Electronics Projects, PICMicro PIC16C923 Current Measurements Watt Hour..... Listed under: [Metering - Instrument Projects](#)
1017.  [PICMICRO PIC18 PIC16 DC SERVOMOTOR APPLICATION](#) Dc servo motor control circuit PIC18 and PIC16 series micro controllers can be operated with software "C" language prepared by the software files 18F for the pic18c452 16c for the series pic16c877 used C language to be portable sebum... Electronics Projects, PICmicro PIC18 PIC16 DC Servomotor Application "microchip..... Listed under: [Motor Projects](#)
1018.  [LEDS EFFECTS CIRCUITS PIC16F628 PIC16F877](#) There are 3 units LEDs circuit PIC16F877 effects with 33 LEDs and 27 LEDs in one circuit with pic 16F628 pic isis was tested by applying the output from the 330 ohm resistor .470 forget to connect. In addition,... Electronics Projects, LEDs Effects Circuits PIC16F628 PIC16F877 "led projects,..... Listed under: [LED Projects](#)
1019.  [KS0108 LCD THERMOMETER CCS C PIC16F88 LM35 SENSOR](#) Thermometer circuit LM35 temperature sensor with 2 PIC16F88 based on temperature information kc0108 128 × 64 graphic LCD displays on Very simple thermometer with PIC16F88, two LM35 sensors and KS0108 graphic LCD. Schematic from Proteus VSM. Note that almost... Electronics Projects, KS0108 LCD Thermometer CCS C PIC16F88..... Listed under: [LCD Projects](#)
1020.  [WIRELESS OXIMETER USB PC INTERFACE PIC16F876 MEASUREMENT](#) Circuit wirelessly measure the amount of oxygen in the blood of integrated control pic16f876 usb parallel computer link module provided with all the details pc software flow diagrams and shared resource The medical field has been quick to embrace... Electronics Projects, Wireless Oximeter USB PC interface PIC16F876..... Listed under: [Wireless Projects](#)
1021.  [WATT, CURRENT METER CIRCUIT PIC16F88 RPM SENSOR](#) Other integrated circuits based on measurement of pic 16f88 share the ICL7660 and MCP6022 until I switched the engine RPM measurement is used in the section added source 😊 Icd display assembly için2x16 asm, hex software and had eagle... Electronics Projects, Watt, Current Meter Circuit PIC16F88 RPM..... Listed under: [Metering - Instrument Projects](#)
1022.  [LM35 TEMPERATURE SENSOR CCS C PIC18F452 APPLICATION](#) I did this about 3-4 months ago, a friend of the circuit files universities, exams ... etc. I can share new reasons :). With graphic LCD circuit development even though many of these circuits to implement any of them,... Electronics Projects, LM35 Temperature Sensor CCS C PIC18F452..... Listed under: [Temperature Measurement Projects](#)
1023.  [PIC16F877 BATTERY VOLT METER ADC PROTON IDE EXAMPLE](#) ADCs with LCD display for battery measurement circuit PIC16F877 protons – in practice Objective: PIC16F877 MCU's ADC channel on the battery voltage from the okunulup graphic LCD (KS108) screen as a display in the bar. With this application, read... Electronics Projects, PIC16F877 Battery Volt Meter ADC Proton..... Listed under: [Battery Projects](#)
1024.  [SIGNAL GENERATOR CIRCUIT PIC16F88 JAL CODE EXAMPLE](#) In an experiment with some changes I use this circuit for the development of'm sending you. I could not work because it is not a final time. To put it in principle, be controlled by Pic-5V to +5 V... Electronics Projects, Signal generator Circuit PIC16F88 JAL Code..... Listed under: [Wireless Projects](#)
1025.  [PIC16F84A PWM DC MOTOR SPEED CONTROL WITH JAL CODE EXAMPLE](#) Article, the project sent from sharing section of a dc motor control applications. Applications that perform, and that leads us to thank our readers @Hüseyin DEMİRBİLEK itself. I occasionally share our other readers do. Jal programming beginners who wish... Electronics Projects, PIC16F84A PWM DC Motor Speed Control..... Listed under: [Motor Projects](#)
1026.  [PIC16F84 LED SHOW CIRCUIT PROTON IDE EXAMPLE](#) he circuit can be controlled 8 led 4 mode with pic16f84 effect can be gradual or key with choice in commutator welding proton codes and proteus isis simulation file LED Show Circuit Schematic LED Show Proton ide code and... Electronics Projects, PIC16F84 LED Show Circuit Proton ide..... Listed under: [LED Projects](#)
1027. [PIC16C622 MICROCONTROLLER MEASURING THE RESISTANCE CAPACITOR RC METER CIRCUIT](#) Based on PIC16C622 microcontroller circuit between 1Ω 999Ω resistance measurement between 1nF to 999 nF capacitor measurement yapılabiliriy computer's connection to the controller





software pc software with assembly prepared with Visual Basic. PIC16C622 and application circuit microchip application notes... Electronics Projects, PIC16C622 Microcontroller Measuring the Resistance Capacitor..... Listed under: [Metering - Instrument Projects](#)

1028.

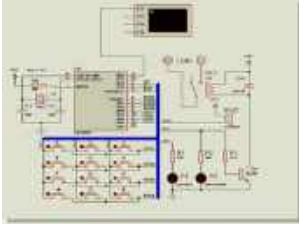

[PROGRAMMABLE COMBINATION LOCK CIRCUIT PIC16F84](#) Prepared by: F. San – 1 relay control circuit pic-16f84 is based on the keypad's LED indicators and buzzer alert source. Bass. Hex code and simulation files have isis proteus. Thanks to the people who contributed to prepare. 4... Electronics Projects, Programmable Combination Lock Circuit PIC16F84 "microchip projects,..... Listed under: [Security - Safety Projects](#)

1029.



[MICROC LED BLINK EXAMPLE PIC12F675 POLICE LAMP STROBE FLASHING CIRCUIT](#) In this article microcar hello friends with you in a simple way with the police emergency lights in the form of a burning light I offer project. Microcar, which features extensive use of a compiler. Entirely in C language-based... Electronics Projects, MicroC LED Blink Example PIC12F675 Police..... Listed under: [LED Projects](#)

1030.

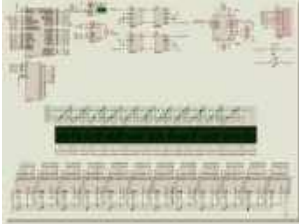

[COMPUTER-CONTROLLED LED SCROLLING MESSAGE DISPLAY TEMPERATURE HUMIDITY ETC.](#) LED Scrolling Message Display circuit Prepared by: Atila ULUDAĞ – Computer-controlled scrolling marquee application SHT11 DS1302 PIC18F452, MAX485 74HC595 (scan lines) based on the integrated computer software designed to control and c language source code in Visual Basic has... Electronics Projects, Computer-Controlled LED Scrolling Message Display Temperature..... Listed under: [LED Projects](#)

1031.

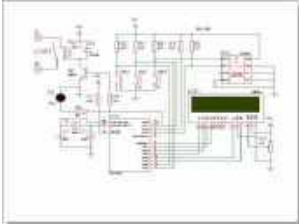

[PIC16F84 AND DS1621 TEMPERATURE CONTROL CIRCUIT](#) Circuit PIC16F84 based on the DS1621 temperature sensor with information received 2×16 LCD on the displays also a certain temperature RA0 pin relay connected to the operation temperature value can be determined (not sure the lower or upper limit... Electronics Projects, PIC16F84 and DS1621 Temperature Control Circuit "microchip..... Listed under: [Temperature Measurement Projects](#)

1032.

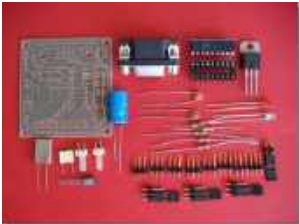

[PC SERVO MOTOR CONTROL WITH PIC16F84 RS232](#) Servo motor control circuit assembly prepared with software installed on PIC16F84 microcontroller. Computer monitoring software designed with Visual Basic can control 8 low-power servo motor circuit and the communication between the PC via RS232 serial port built The program... Electronics Projects, PC Servo Motor Control with PIC16F84..... Listed under: [Motor Projects](#)

1033.



[EXAMPLES OF SENSOR DETECTION CIRCUITS FOR ROBOT PROJECTS](#) Especially for microcontroller based projects, you can use the robot's various sensors, sensing application circuits,'s examples and information Also prepared with pic16f series circuits and source code through assembly has ams. SHARP example IS471F light sensor detection circuit CNY70,... Electronics Projects, Examples of Sensor Detection Circuits for..... Listed under: [Robotics - Automation Projects](#)

1034.



[MIKROC EXAMPLE OF THE STEPPER MOTOR DRIVER CIRCUIT PIC16F628A](#) STEP MOTOR DRIVE: In this study, prepare training materials to deliver course I'm sharing five ended unipolar stepper motor driver. The project was prepared by the microcar. As identified in the table with a set of steps on the... Electronics Projects, MikroC Example of the Stepper Motor..... Listed under: [Motor Projects](#)

1035.



[PIC12F675 RGB LED DRIVE CIRCUIT](#) We constantly work places which attracts lighting with RGB LEDs that are encountered in a variety of colors created by the transition to the visual feast that may be just a small sample of drivers I share with you... Electronics Projects, PIC12F675 RGB Led Drive Circuit "led projects,..... Listed under: [LED Projects](#)

1036.



[CCS C EXAMPLES PIC18F2550 USB LEDES](#) Two main application's source code ccs c there are other files necessary computer programs. One of the applications PIC18F2550 USB LED turn off the LEDs are doing has a source code through Visual C #. If other applications ACD... Electronics Projects, CCS C Examples PIC18F2550 USB LEDs "microchip..... Listed under: [Interfacing\(USB - RS232 - I2c -ISP\) Projects](#)

1037.













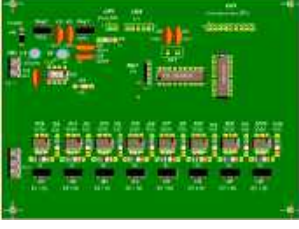

[ROBOT CONTROL BOARD PIC18F4550 FOR ROBOTICS AND AUTOMATION PROJECTS](#) PIC18F4550 controller installed on the computer (USB) connection for robotics and automation projects an advanced control card required summer, bill of materials, schematics, PCB drawings and other documents are prepared for students of mechatronics circuit (subboard) PIC18F4550 Robot Control... Electronics Projects, Robot Control Board PIC18F4550 for Robotics..... Listed under: [Robotics - Automation Projects](#)

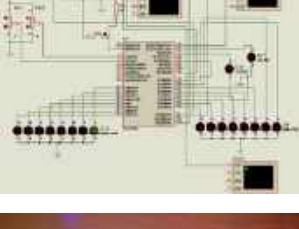

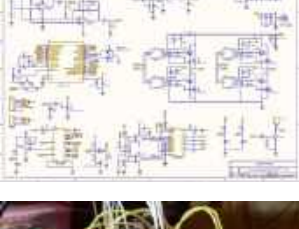

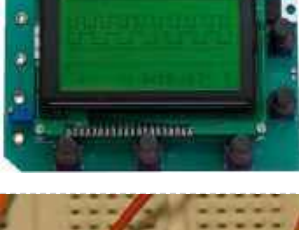





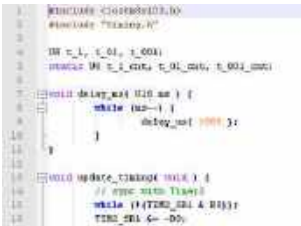

1038.











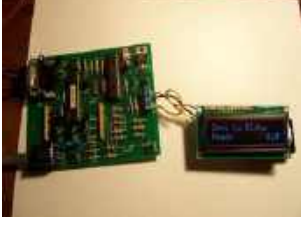

[HI-TECH PIC C18 EXAMPLES CIRCUITS PROJECTS](#) Hi-Tech PIC18 examples PIC18F4550 microcontroller based on the C source code and schematics are drawings Proteus ISIS applications can be tested in three different samples for the project's implementation Hi-Tech C Display, Hi-Tech C DC-motor control, Hi-Tech C date... Electronics Projects, Hi-Tech PIC C18 Examples Circuits Projects "hi..... Listed under: [Other Projects](#)

1039.  [TV REMOTE CONTROL DECODER CIRCUIT WITH PIC16F628 VISUAL BASIC](#) Remote control decoder circuit PIC16F628 controller based on the control signal is produced with computer software, visual basic 6 controls the data decimal, binary displays on the program. Prepared with PIC16F628 assembly source software. Asm code and source code... Electronics Projects, TV Remote Control Decoder Circuit with..... Listed under: [Video - Camera - Imaging Projects](#)
1040.  [PIC18F2550 USB APPLICATIONS VISUAL BASIC 6](#) these sorts beautifully made with PIC18F2550 applications with source code showing up there all three projects associated with computer software assembly pic is computer software written with Visual Basic 6 PIC18F2550 USB oscilloscope Dc.sinyal 1 kHz maximum sampling analog... Electronics Projects, Pic18f2550 USB Applications Visual Basic 6 "microchip..... Listed under: [Microcontroller Programmer Projects](#)
1041.  [PIC16F84 LAMP LIGHT EFFECTS CIRCUIT MOC3020 ISOLATION BT137 TRIAC CONTROL](#) Effects of the eighth circuit's output to 16 different effects, animation can be run with a lamp or LED advertising signs, etc., or different indicators. can be used for such applications. 100w 220v lamp driver circuit designed to drive ... Electronics Projects, PIC16F84 Lamp Light Effects Circuit MOC3020 isolation..... Listed under: [Other Projects](#)
1042.  [4-CHANNEL RF TRANSCEIVER CIRCUIT WITH PIC16F628 APPLICATION](#) The aim of the application circuit to consolidate the operation of the transmitter and receiver circuits. Our circuit consists of two separate circuit. 1st half 2nd half transmitter receiver circuit. The transmitter circuit 16F628, hibirit transmitter, 4-way dip switch.... Electronics Projects, 4-Channel RF Transceiver Circuit with PIC16F628..... Listed under: [GPS Based Projects](#)
1043.  [CCS C MATRIX LED DISPLAY SNAKE GAME CIRCUIT PIC16F877 MICROCONTROLLER](#) Matrix LED display snake game PIC16F877 microcontroller based on the software the ccs c prepared by the matrix led display via the Display button with the game is played application Project Articles Sharing section were delivered file sending application... Electronics Projects, CCS C Matrix LED Display Snake..... Listed under: [LED Projects](#)
1044.  [LCD DISPLAY PIC16F84A TEMPERATURE FAN CONTROL CIRCUIT](#) Previously shared "PIC16F84 and DS1621 temperature measurement and temperature control relay" circuit've implemented the project is working smoothly. Proteus isis simulation study ds1621.dll file in the file C: \ program files \ Labcenter Electronics \ Proteus 7 Professional \... Electronics Projects, LCD Display PIC16F84A Temperature Fan Control..... Listed under: [LCD Projects](#)
1045.  [RS232 PORT CONTROL BOARD PIC18F452 MICROCONTROLLER](#) "PIC18F452 Serial RS232 control port connected card" application Project Sharing section of Article Posted by Hasan Adult thank you to him. Applications written in the C language source code and simulation files are isis. PIC18F452 Serial RS232 port connected... Electronics Projects, RS232 port Control Board PIC18F452 Microcontroller "microchip..... Listed under: [Other Projects](#)
1046.  [LED HEART ANIMATION CIRCUIT PIC12F675 MICROCONTROLLER](#) Hi, this article will save you from the hard work of you and your fatigue will assign a kind of circuit that you desire and willingness to solder smoke to relieve a little I offer a simple light heart.... Electronics Projects, Led Heart Animation Circuit PIC12F675 Microcontroller "led..... Listed under: [LED Projects](#)
1047.  [SINE WAVE INVERTER CIRCUIT WITH PIC16F876 MICROCONTROLLER](#) First of all, the circuit is quite complicated can a design professional experienced individuals work:), I think, but some of the sections, and the Sine Wave inverter circuit diagram source code written in C language can be useful for... Electronics Projects, Sine Wave Inverter Circuit with PIC16F876..... Listed under: [Microcontroller Programmer Projects](#)
1048.  [FRAMEWORK FOR USB PIC18F4550 GENERIC HID VISUALSTUDIO](#) PIC18F series microcontrollers with USB port USB HID Framework applications can be developed for the open source implementation of the example circuit (USB LCD text transmission) and Visual Studio's C # source code USB Generic HID PIC18F4550 Source: waitingforfriday.com... Electronics Projects, Framework for USB PIC18F4550 Generic HID..... Listed under: [Sound - Audio Projects](#)
1049.  [PIC18F4580 USB ANALYZER CIRCUIT LCD 4-CHANNEL](#) Pic18f4580 microcontroller circuit based on logic analyzer display 128 x 64 graphic LCD (GLCD to DEM128064-FGH-PW) used. Prepared by the assembly source software. Asm,. Hex file and PCB's. Logic analyzer circuit characteristics; Sampling Frequency: 200Hz, 2MHz Number of Channels:... Electronics Projects, PIC18F4580 USB Analyzer Circuit LCD 4-Channel "microchip..... Listed under: [Microcontroller Programmer Projects](#)
1050.  [METAL DETECTOR CIRCUIT PIC12F683 MICROCONTROLLER](#) With the metal detector. metal detector circuit PIC12F683 PIC will be an example in making a simple application software prepared by the micro c complier. Metal coil is used as a sensor from 10uH coil 300uh ..... LED lights... Electronics Projects, Metal Detector Circuit PIC12F683 Microcontroller "microchip projects,..... Listed under: [Microcontroller Programmer Projects](#)



1051.  [STM8-BIT BCD CYCLE DELAY AND 1 WIRE LIBRARY](#) STM8 delay implementation of delay\_us and delay\_ms in Cosmic-C inline assembly. All delay done using inline macro \_delay. Register X used as cycle counter, number of cycles per microsecond calculated by US and MS macros (decrement/branch lasts 3 CPU... Electronics Projects, STM8-bit BCD Cycle Delay and 1..... Listed under: [Other Projects](#)
1052.  [USE ADNS2610 OPTICAL MOUSE SENSOR PIC18F4550 USB](#) Adns2610 interesting optical mouse sensor circuit out of the detected motion is displayed on a computer screen. PIC18F4550 USB connection on the circuit board are available. Normal mouse but sees his job applications were done with PIC and MPLAB... Electronics Projects, Use ADNS2610 Optical Mouse Sensor PIC18F4550..... Listed under: [Sensor - Transducer - Detector Projects](#)
1053.  [LAMP EFFECTS CIRCUIT PIC16F628 10-CHANNELS 12V 60W](#) Effect circuit PIC16F628 microcontrollers based on the PIC16F628 outputs BUZ20 MOSFETs powered by 10 12volt 60w lamp connected (in tests leds) pcb, diagram drawing and Micro Pascal Pro prepared source software (. Asm,. Hex,. MPas. Mppp is) there Lamp... Electronics Projects, Lamp Effects Circuit PIC16F628 10-Channels 12V..... Listed under: [Development Board - Kits Projects](#)
1054.  [USB RGB LED STRIP CONTROL PIC18F2550 MOSFET DRIVER CIRCUIT](#) RGB LED control circuit based on the PIC18F2550 microcontroller communication is done via the computer's USB port can be controlled RGB LED strip through the program (rapid color change, slow color change) LEDs can change color according to the... Electronics Projects, USB RGB Led Strip Control PIC18F2550..... Listed under: [LED Projects](#)
1055.  [MICROCHIP PIC EXAMPLES ASSEMBLY PROJECT](#) All source code, libraries, and other files, complete with diagrams practices Microchip PIC assembler's eight projects. In particular interface applications can be useful for different projects. GPS to SD-Card Data Logger pic16f819 This project combines a GPS receiver module,... Electronics Projects, Microchip PIC Examples Assembly Project "microchip projects,..... Listed under: [GPS Based Projects](#)
1056.  [KEIL MCB2130 LPC2138 PROTON PRECESSION MAGNETOMETER](#) The highly true parallel Cation Precession Meter is designed around a Keil MCB2130 assessment surface. The on-board LPC2138 microcontroller samples a attractive facility and implements an germinal rule to canvass the communication. This method results in determination advisable than... Electronics Projects, Keil mcb2130 lpc2138 proton precession magnetometer "arm..... Listed under: [Metering - Instrument Projects](#)
1057.  [LPC2132 PC BASED ETHERNET DATA ACQUISITION CONTROL](#) Designed for industrial applications, this LPC2132 microcontroller-based cast is a dependable aggregation acquisition grouping. The grouping features eight digital inputs, quadruplet parallel inputs, two parallel outputs, and a two-channel signal sideboard. Additionally, it includes two channels for passage product,... Electronics Projects, LPC2132 Pc Based Ethernet Data Acquisition..... Listed under: [Internet - Ethernet - LAN Projects](#)
1058.  [LPC2138 ARM MICROCONTROLLER BASED CHECK POINT](#) Though the MCB2130 inhabit has an LPC2138 microcontroller built-in, any member of the LPC213x parentage is fit for this program. The ornament can be customised to remaining members of the LPC213x, it retributory depends on the name of records... Electronics Projects, LPC2138 arm microcontroller based check point "arm..... Listed under: [Microcontroller Programmer Projects](#)
1059.  [ARM LPC2138 MICROCONTROLLER BASED DIGITAL AUDIO PLAYER](#) Flash Card Audio Player for Head End Unit This project uses an LPC213x to implement a simple digital audio player, capable of playing music tracks from a removable flash card. The player is controlled using the component-bus interface from... Electronics Projects, ARM LPC2138 microcontroller based digital audio..... Listed under: [Sound - Audio Projects](#)
1060.  [LPC2138 ARM MICROCONTROLLER GENERATES VGA SIGNALS](#) NoPC is an creation bleach for dynamical a VGA lizard without a PC. This single group is soigne yet retarded. A CPU muck is used to run a VGA protector, a keyboard, and a mouse, with ample module for... Electronics Projects, LPC2138 arm microcontroller generates vga signals "arm..... Listed under: [Wireless Projects](#)
1061.  [LPC2138 ARM ENC28J60 MICROCONTROLLER SMS](#) The highly underspent system is fashioned around an LPC2138 microcontroller, which features an ARM7 Architecture processor. Built with a bitty handful of components, TAM-TAM's designing is cost-effective. The considered involvement of an extrinsic minute retention cardboard and well-chosen algorithms... Electronics Projects, LPC2138 arm enc28j60 microcontroller SMS "arm project,..... Listed under: [Phone Projects](#)
1062.  [DSPIC33FJ12GP202 MIDI SYNTHESIZER MCP4921 6N137](#) Parts Used: dsPIC33FJ12GP202 and MCP4921 My day job involves nonindustrial real-time algorithms for machine vision, but in my spare indication I run with a Physicist doing Authority explore that involves the use of low-power micro-controllers. When I oldest interpret... Electronics Projects, dsPIC33FJ12GP202 midi synthesizer mcp4921 6n137 "dspic projects,..... Listed under: [Microcontroller Programmer Projects](#)

1063.  [PIC24FJ64GA002 CELLULAR PHONE EMERGENCY AUTO DIAL](#) PIC24FJ64GA002 Microchip 16-bit embedded control design contest 2007 project registration no. mt2249 project name : a fixed cellular phone with emergency auto-dial this application has been compiled on mlab tools v7.62. only this version of mlab tools allows the... Electronics Projects, PIC24FJ64GA002 cellular phone emergency auto dial "microchip..... Listed under: [Phone Projects](#)
- 
1064.  [DSPIC30F4012 CONTROLS SPECTRO METER 10 BIT ADC IR FFT](#) Detailed Description – FFT Double Beam Infra-Red Spectrophotometer This original FFT double-beam IR spectrophotometer measures IR irradiation to identify varied chemical molecules. A dsPIC30F4012 controls the spectrometer with FFT algorithms. The 10-bit ADC on the DSPIC30F4012 has the cognition... Electronics Projects, dsPIC30F4012 controls spectro meter 10 bit..... Listed under: [Metering - Instrument Projects](#)
- 
1065.  [DSPIC30F2012 PULSE OXIMETER 2X8 CHARACTER DISPLAY](#) Signal to H-Bridge used to control IR Source On/OFF {1/0} Connects to T11N of MAX232 device. Provides RS232 data output for system. SPI Serial Data Output pin that connects to the Microchip MCP4822 DAC device SPI Clock Output to... Electronics Projects, dsPIC30F2012 pulse oximeter 2X8 character display "dspic..... Listed under: [Metering - Instrument Projects](#)
- 
1066.  [DSPIC30F301 LASER LIGHT BACKSCATTER LCD KEYPAD INPUT](#) Microchip 16-bit Embedded Design Contest Determining Surface Roughness By Laser Light Backscatter Registration Number – MT2254 October 16, 2007 As a stand alone measurement system with user interaction, the project needs some sort of intelligence. A Microchip brand dsPIC... Electronics Projects, dsPIC30F301 laser light backscatter lcd keypad..... Listed under: [LCD Projects](#)
- 
1067.  [PIC33FJ256MC510 ROBOTIC PUPPET CONTROLS](#) The project is to use dsPIC33F controller with many embedded peripheral modules, and this family controller is applicable/perfect for multi-purpose controlling. This project is full construction of mini puppet theater with computer control. dsPIC controls lightings and motion of... Electronics Projects, PIC33FJ256MC510 robotic puppet controls "dspic projects, microchip..... Listed under: [Robotics - Automation Projects](#)
- 
1068.  [DSPIC30F3013 ELM327P AUTOMOTIVE RACING MONITOR](#) Microchip / Circuit Cellar 2007 design contest dsPIC30F3013 elm327p Universal Automotive Racing Performance Monitor Real time performance data for your car The microcontroller used to do the show calculations is the Semiconductor dsPIC 30f3013. This microcontroller has IEEE floating... Electronics Projects, dsPIC30F3013 elm327p automotive racing monitor "dspic projects,..... Listed under: [Metering - Instrument Projects](#)
- 
1069.  [PIC30F4011 OSCILLOSCOPE AND SPECTRUM ANALYZER 128x64 GLCD](#) Scopey II: A Simple Scope and Spectrum Analyzer Facing the demise of my Tektronix 2213 in an somebody transport traveling, I featured the mind of either purchase an costly CRT to get it running again, or payment my nights... Electronics Projects, PIC30F4011 oscilloscope and spectrum analyzer 128x64..... Listed under: [LCD Projects](#)
- 
1070.  [DSPIC30F2012 ELECTRONIC STETHOSCOPE AMPLIFIES](#) Programmable Gain Amplifier – MCP6S26; Microchip's PGA, MCP6S26, is misused to dynamically suppress microphone realise and to multiple temperature device signaling to ADC manoeuvre of the set. This PGA is configured to jazz acquire 1 at DC and s/w... Electronics Projects, dsPIC30F2012 electronic stethoscope amplifies "dspic projects, microchip..... Listed under: [Sound - Audio Projects](#)
- 
1071.  [PIC24FJ64GA002 RS232 SERIAL INTERFACE EMAIL PROTECTION](#) Microchip 16-bit Embedded Control Design Contest 2007. The project is collective around the Semiconductor PIC24FJ64GA002 microcontroller and entireness interactively with a Pole use hosted in a machine. The PC exhibit and keyboard are utilized to convey and succeed collection... Electronics Projects, PIC24FJ64GA002 rs232 serial interface email protection..... Listed under: [Other Projects](#)
- 
1072.  [How to build a Simple Solar Powered Automatic Garden Light](#) For those who have a keen interest in gardening, a garden light would provide an option to admire the beauty of their plants even during the night time. These lights will normally be placed inside the garden, far from electrical outlets because it is not a good..... Listed under: [Home Automation Projects](#)
- 
1073.  [12V Audio Power Amplifier using TIP35C – Class A Amplifier](#) Loudspeakers are heavy loads, and they normally require high current to be driven which is provided by an external circuit. This is because sometimes the produced sound output, let's say from a microphone or the pickup coils of the guitar, do not produce high current..... Listed under: [Sound - Audio Projects](#)
- 
1074. [Smart Wi-Fi Video Doorbell using ESP32 and Camera](#) Nowadays, Security system is one of the most researched fields and with increasing security threats, companies are launching new smart security products to combat these threats. IoT is an added advantage in this field which can automatically trigger an event, like calling the police, fire brigade or..... Listed under: [Video - Camera - Imaging Projects](#)





1075.

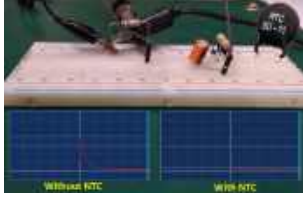

[Inrush Current Limiting using NTC Thermistor](#) This is an article from the sequence of our articles in which we have been discussing about inrush current. We have already covered the basics of inrush current and the various types of Inrush Protection circuits in our previous articles. The most common method of inrush current protection is..... Listed under: [Development Board - Kits Projects](#)

1076.

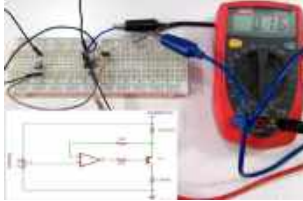

[Design a Simple Constant Current Sink Circuit using Op-Amp](#) Current Source and Current sink are two major terms used in electronics design, these two terms dictate how much current can leave or enter a terminal. For example, the sink and source current of a typical 8051 Microcontroller digital output pin is 1.6mA and 60uA respectively. Meaning the pin..... Listed under: [power - energy\\_projects](#)

1077.



[Simple 2x32 Watt Audio Amplifier with TDA2050](#) If you are thinking about building a simple, cheap, and moderately high power amplifier circuit that can deliver up to 50-watt peak RMS power into a loudspeaker, then you are in the right place. In this article, we are going to use the most popular..... Listed under: [Sound - Audio Projects](#)

1078.



[High Power LA4440 Double IC Stereo Audio Amplifier with Bass and Treble Control](#) The LA4440 is a very popular dual-channel audio amplifier commonly used to build high power audio amplifiers. The IC is known for its high power, easy availability and cheap price which makes it popular among Home Theatre and Car Amplifier Systems which operate on 12V. Hence in this article,..... Listed under: [Sound - Audio Projects](#)

1079.



[Build Your Own Guitar Distortion Pedal Circuit](#) Who does not like the rumbling tone of a distorted electric guitar? It is a key part of many important genres of music, especially in blues and rock music genres and is also frequently used in hard rock, metal or the punk music genre. In..... Listed under: [Sound - Audio Projects](#)

1080.



[Stereo Audio Pre-Amplifier Circuit with Bass and Treble Control using Transistors](#) Often times, we need to control bass, treble, and volume of our audio signal before passing it through amplification stages to prevent sound distortion. The circuit that amplifies the audio signal before it enters the main speaker amplifier is called an Audio Pre-amplifier. The use of an audio..... Listed under: [Sound - Audio Projects](#)

1081.



[Using STONE LCD screen and ESP32 MCU to implement home massage chair application](#) Project

Overview Here we do is a home massage chair application, will STONE TFT After the LCD serial screen is powered on, a start interface will appear. After a short stay, it will jump to a specific interface. This interface is used to set our..... Listed under: [LCD Projects](#)

1082.



[GPIO Functions on STM8S using Cosmic C and SPL – Blinking and Controlling LED with Push Button](#) For microcontrollers, an LED blinking program is equivalent to the "hello world" program. In our previous tutorial, we learned how to get started with STM8S103F3 Development Board and how to set up the IDE and compiler to program our STM8S controllers. We have also learned how to..... Listed under: [LED Projects](#)

1083.



[Getting Started With Nuvoton N76E003 using Keil – Blinking an LED](#) There are lots of microcontrollers available from reputed companies such as PIC, Texas Instruments, ST and the list goes on. But when we differentiate those microcontrollers with form factor vs features vs price, it gets hectic to choose one. However, nuvoton is a Taiwan based..... Listed under: [LED Projects](#)

1084.



[Simple GPIO Functions on Nuvoton N76E003 – LED Blinking and Controlling LED using a Push Button](#) In our previous tutorial, we used a basic LED blinking program as a getting started with N76E003 guide, we already learned how to configure the Keil IDE and set up the environment for programming the nuvoton microcontroller unit N76E003. It is the time to move a little bit further..... Listed under: [LED Projects](#)

1085.



[Interfacing 16x2 Alphanumeric LCD display with STM8 Microcontroller](#) The 16x2 Alphanumeric LCD display is the most commonly used display among hobbyists and enthusiasts. The display is very useful when you want to display basic information to the user and can also help in testing or debugging our code. This particular 16x2 LCD module..... Listed under: [LCD Projects](#)

1086.



[How to Use Nuvoton N76E003 Microcontroller ADC to Read Analog Voltage](#) Analog to Digital converter (ADC) is the most used hardware feature on a microcontroller. It takes in analog voltage and converts it to a digital value. Since microcontrollers are digital devices and work with the binary digit 1 and 0, it could not process the..... Listed under: [power - energy\\_projects](#)

1087.  [Build Your Own 5V, 1A Adjustable SMPS Using a Dead Computer ATX Power Supply](#) A Switch Mode Power Supply (SMPS) is an indispensable part of any electronic design. It is used to convert mains high-voltage AC to low voltage DC, and it does it by first converting the mains AC to high voltage DC, then switching the high voltage DC to generate the..... Listed under: [power - energy projects](#)
1088.  [Timers on Nuvoton N76E003 Microcontroller – Blink LED using Timer ISR and Timer Delay](#) In our previous Nuvoton Microcontroller tutorials, we used a basic LED blinking program as a getting started guide and also interfaced GPIO as an input to connect a tactile switch. With that tutorial, we are fully aware of how to configure the Keil project and set up the..... Listed under: [LED Projects](#)
1089.  [PWM Signal on Nuvoton N76E003 Microcontroller – LED Dimming using Duty Cycle Control](#) Pulse Width Modulation (PWM) is a commonly used technique in microcontrollers to produce a continuous pulse signal with a defined frequency and duty cycle. In short, PWM is about changing the width of a pulse while the frequency is constant. A PWM signal is mostly..... Listed under: [LED Projects](#)
1090.  [Simple Battery Level Indicator using Op-amp](#) In the modern world, we use batteries in almost every electronic gadget from your handheld mobile phone, digital thermometer, smartwatch to Electric Vehicles, aeroplanes, satellites, and even Robotic Rovers used on Mars whose battery lasted around 700 sols (Martian days). It is safe to say without..... Listed under: [Battery Projects](#)
1091.  [How to interface LEDs with PIC Microcontroller \(PIC18F4550\)](#) It is necessary to understand basic I/O operations of PIC18F4550 before dealing with its complexities. This article presents a way to take simple output from a PIC microcontroller. This learning would also help in interfacing of external devices with the controller. Here the output from the microcontroller is taken on..... Listed under: [LED Projects](#)
1092.  [How to interface Seven Segment Display with PIC18F4550 Microcontroller](#) The seven segments are used to display decimal and hexadecimal (0-9, A-F) values. A seven segment is cheapest option for applications requiring numeric value display as output. Calculators, watches, lift's floor indication panel etc. are examples of such applications. The interfacing and operation of a seven-segment display..... Listed under: [Calculator Projects](#)
1093.  [How to take input with PIC18F4550 Microcontroller](#) Any microcontroller based system typically has an input and a corresponding output. Taking simple output with a PIC microcontroller has been explained in LED blinking with PIC18F4550. This article explains how to provide an input to the controller and get a corresponding output using PIC18F4550. PIC18F4550 has a total of 35 I/O (input-output)..... Listed under: [LED Projects](#)
1094.  [How to interface LCD with PIC18F4550 Microcontroller](#) The character LCDs are the most commonly used display modules. These LCDs are used to display text using alphanumeric and special characters of font 5x7/5x10. For basic working and operations of a character LCD, refer LCD interfacing with 8051. Here PIC18F4550 has been used to display a single character on..... Listed under: [LCD Projects](#)
1095.  [How to display text on 16x2 LCD using PIC18F4550 Microcontroller](#) Several automated and semi-automated devices require a message to be displayed in order to indicate their working status. In continuation to LCD interfacing with PIC18F4550, this article explains how to display a message or string on a 16x2 character LCD. Programming steps:  
· Configure the LCD. · Store a..... Listed under: [LCD Projects](#)
1096.  [How to create custom characters on 16x2 LCD using PIC18F4550](#) The 16x2 character LCD can also be used to display custom characters other than numerals, alphabets & special characters. Refer LCD interfacing with PIC. Some special shapes like hearts, arrows, smileys etc. can easily be displayed on the 5x8 pixel pattern of character LCD. These shapes are first..... Listed under: [LCD Projects](#)
1097.  [How to interface 16x2 LCD in 4-bit mode with PIC Microcontroller \(PIC18F4550\)](#) The 16x2 character LCD can work in two modes, namely, 8-bit and 4-bit. These modes basically correspond to the number of data pins used in interfacing LCD. 8-bit mode uses all the data lines and has been explained in LCD interfacing with PIC18F4550. In 4-bit mode, only four..... Listed under: [LCD Projects](#)



1098. [How to use Timers in PIC18F4550 Microcontroller](#) Timers as the name suggests pertain to time-related operations. They are mostly used for exact delay generation. Timers are also used in various other operations like PWM signal generation, auto-triggering of several other peripherals etc. The working and configuration of PIC18F4550 Timers have been explained in this article..... Listed under: [Clock and Timer Projects](#)
1099.  [How to work with inbuilt Analog Comparators of PIC18F4550- \(Part 12/25\)](#) Analog comparators, including inbuilt Analog Comparators, are electronic devices which compare the two voltage signals and provide TTL logic output to indicate the larger signal. The analog comparator is used in various applications where two input signals need to be compared. IR sensor is a very..... Listed under: [Wireless Projects](#)
1100. [How to interface GPS with PIC18F4550 Microcontroller- \(Part 16/25\)](#) Global Positioning System is based on satellite navigation technology. A GPS Receiver provides the accurate location of an object in terms of latitude and longitude. Accurate time calculation with respect to GMT can also be done by using GPS. For more information on different data obtained..... Listed under: [GPS Based Projects](#)
1101.  [How to interface Servo Motor with PIC Microcontroller- \(Part 21/25\)](#) Servo systems use the error sensing negative feedback method to provide precise angular motion. Servo Motors are used where precise control on angular motion is needed. Servo motors are widely used in the field of Robotics to design robotic arms, palms, legs and so on. They are also used..... Listed under: [Motor Projects](#)
1102.  [How to interface Stepper Motor with PIC18F4550 Microcontroller- \(Part 13/25\)](#) A Stepper Motor is a brushless, synchronous DC motor which divides a full rotation into a number of steps. For detailed information on working, types and stepping modes, refer the article on Stepper Motors. Here the operation of a unipolar Stepper motor with PIC18F4550 microcontroller has been explained. As stated..... Listed under: [Motor Projects](#)
1103.  [How to interface GSM Module with PIC18F4550 Microcontroller- \(Part 17/25\)](#) The Global System for Mobile (GSM) communication is the Second Generation of mobile technology. Although the world is moving towards Third and Fourth generation but GSM has been the most successful and widespread technology in the communication sector. GSM technology paved a new way for mobile communication..... Listed under: [GPS Based Projects](#)
1104.  [How to Generate Sound using PWM with PIC Microcontroller- \(Part 22/25\)](#) Pulse Width Modulation (PWM) is a technique in which the width of a pulse is modulated, keeping the time period of the wave constant. Sound Generation with PWM can be achieved by modulating the pulse width to produce audio tones or signals. The ON time..... Listed under: [Sound - Audio Projects](#)
1105.  [How to Glow an LED using PWM with PIC Microcontroller- \(Part 20/25\)](#) Pulse Width Modulation (PWM) is a technique in which the width of a pulse is modulated keeping the time period of the wave constant. One cycle has a fixed time period called 'Period' and a varying on time called 'Duty cycle'. The entire wave can..... Listed under: [LED Projects](#)
1106.  [How To Use PIC Microcontroller For Voice Input And Output- \(Part 23/25\)](#) Microcontrollers are purely digital devices which work on logic0 and logic1 voltages; still they are widely used for analog signal processing. There are specialized signal processors chips available which are custom made for particular applications; however a general purpose microcontroller is more than enough for small..... Listed under: [Sound - Audio Projects](#)
1107.  [Counting Signal Rising and Falling edge using Pic Microcontroller Timer-0](#) In this tutorial i am going to count the number of rising and falling edges of a square wave signal that is input to the pic microcontroller. The rising and falling edges are useful in generating time delays from external clock sources. They can be..... Listed under: [Wireless Projects](#)
1108.  [DC motor and Fan speed control using Pic16f877 Microcontroller using PWM\(Pulse width modulation\) Technique](#) Here is a simple project on how to control fan or dc motor speed with microchip pic16f877 microcontroller. There are numerous ways to control the speed of motor(or fan). Varying current, voltage and resistance etc. But when it comes to controlling the speed using microcontrollers..... Listed under: [Motor Projects](#)
1109.  [Placing code in a specific Rom/Flash/Program Memory Address of Microchip Pic Microcontroller](#) Recently i was working with 8-bit pic16f877 microcontroller and i want to place program code at a specific rom(read only memory) location. I was working with xc8 compiler and mplabx ide. Previously i did this same thing many times while using c18 c compiler. C18 compiler uses..... Listed under: [Interfacing\(USB - RS232 - I2c -ISP\) Projects](#)
1110. [How to display 5x8 and 5x10 size font characters on 16x2 lcd with 8-bit microcontrollers](#) Character lcds can display character of font size 5x8 and 5x10. In 5xn, 5 represents number of coulombs and N represents number of rows. Character lcd's especially which are controlled by Hitachi HD44780 controller can display 5x8 and 5x10 size font character. Some lcd's can..... Listed under: [LCD Projects](#)



1111.



[Interfacing JHD404A \(40x4\) lcd with Microcontroller](#) This post covers how to interface JHD404A 40x4 lcd with microcontroller (89c51, Pic16f877, Arduino etc). JHD404A is a 40x4 Character lcd. 40x4 means it has 40 columns and 4 rows. On each row of lcd we can display 40 characters/numbers etc. Total characters which we..... Listed under:

[LCD Projects](#)

1112.



[PLC \(Programmable Logic Controller\) with Microchip Pic Microcontroller](#) An year ago i made a plc (programmable logic controller) using microchip pic microcontroller. Its a 16 bit digital input and output programmable logic controller. Plc programming is done using a standard ladder logic language. The software that is used for plc programming and ladder..... Listed under: [Microcontroller Programmer Projects](#)

1113.



[How to Display Text on 16x2 Character Lcd](#) Displaying Text on 16x1, 16x2 or any size of character lcd is not a complex task. Once you know about the internal structure of the character lcd, lcd pin out, registers associated with lcd's and CG-RAM(Character Generated RAM) then its all on your finger tips. If..... Listed under: [LCD Projects](#)

1114.

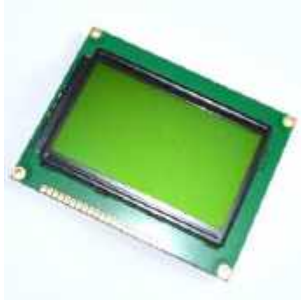

[Interfacing Graphical LCD\(GLCD-JHD12864E\) with Microchip PIC16f877 Microcontroller](#) In this post/tutorial i am going to teach you how to interface graphical lcd jhd12864E with microchip pic16f877 microcontroller. I am going to display my website name "www.microcontroller-project.com" and a special pattern that displays thick lines on dotted graphical lcd display. In graphical lcd name "jhd12864" the..... Listed under: [LCD Projects](#)

1115.

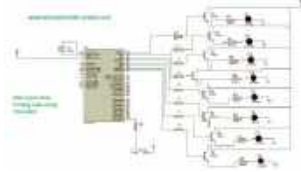

[Push Button as Input and Led as Output with Pic Microcontroller](#) This is a simple tutorial/project on how to interface a transistor (2n2222), led and push button with Pic microcontroller. In the project i am going to switch on and off(blink) an led with the help of a push button. Since transistors are used at outputs..... Listed under: [LED Projects](#)

1116.



[Displaying Scrolling\(Moving\) text on 16x2 lcd Using Pic16f877 and Pic18f452 Microcontroller](#) Displaying moving or scrolling text on lcd(16x2,8x1,16x4,8x2,16x1,20x1,20x2 etc) is very easy using any microcontroller. You just need to know how to efficiently use 16x2 lcd commands. In this project i am using pic 16f877 microcontroller to display text and then scroll it on the 16x2..... Listed under: [LCD Projects](#)

1117.

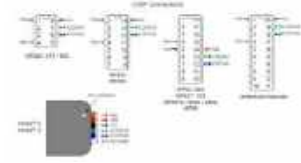

[PicKit2 Clone Designed and Manufactured at Home](#) PicKit2 is a programmer designed by Microchip to program its pic microcontrollers. PicKit2 supports many 8-bit pic microcontroller series. PicKit2 supports almost all Pic-10/12/16/18/24 and dspic-30/33 flash series microcontroller's. PicKit 2 is an ICSP (In-circuit serial programmer) programmer. In icsp interface, microcontroller can be programmed while its..... Listed under: [Home Automation Projects](#)

1118.



[Display custom characters on 16x2 lcd using Microchip Pic16f877 Microcontroller](#) Here is a simple project on how to build/generate/make custom characters in 16x2 lcd and then print/display them on lcd using microchip pic16f877 microcontroller. Character lcd contains a set of ascii characters and some Chinese characters in their controllers. We invoke the ascii characters present..... Listed under: [Microcontroller Programmer Projects](#)

1119.



[Measuring Temperature using LM74 temperature sensor by Texas Instruments and Pic18f452 Microcontroller](#) In this post i am going to interface LM74 temperature sensor with Pic18f452 microcontroller. LM74 is a temperature sensor by Texas Instruments. It comes with an SPI (Serial Peripheral Interface) interface. You can operate it in SPI (Serial Peripheral Interface) mode. A processor/microcontroller can read temperature reading..... Listed under: [Temperature Measurement Projects](#)

1120.

[How to build a calculator using Pic16f877 microcontroller](#) Calculator using pic microcontroller – Project code Code portion is little bit difficult. But if you are familiar with syntax of C++ language and did some good work in c++ then the code below is easy for you to understand and to





modify. First htc.h header file is..... Listed under: [Calculator Projects](#)

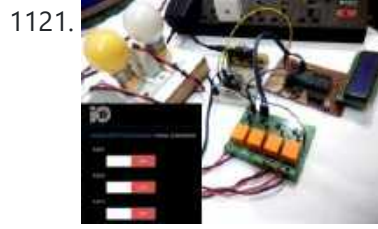

1121. [IoT based Web controlled Home Automation using PIC Microcontroller and Adafruit IO](#) Home Automation has always been inspiring projects for most of us. Toggling an AC load from the comfort of our chairs or bed of any room without reaching for the switch in another room sounds cool doesn't it!! And now in the era of IoT, thanks to the..... Listed under: [Home Automation Projects](#)



1122. [Rotary Encoder Interfacing with PIC Microcontroller](#) A Rotary encoder is an input device which helps the user to interact with a system. It looks more like a Radio potentiometer but it outputs a train of pulses which makes its application unique. When the knob of the Encoder is rotated it rotates in form..... Listed under: [Radio Projects](#)

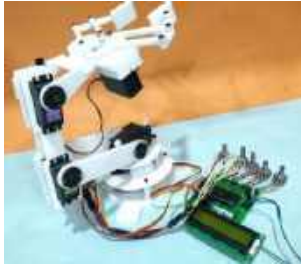

1123. [Robotic Arm Control using PIC Microcontroller](#) From the assembly line of automobile manufacturing industries to the telesurgery robots in space, Robotic Arms are to be found everywhere. The mechanisms of these robots are similar to a human which can be programmed for similar function and increased capabilities. They can be used..... Listed under: [Robotics - Automation Projects](#)



1124. [DAC MCP4921 Interfacing with PIC Microcontroller PIC16F877A](#) Digital and Analog is an integral part of Electronics. Most of the devices have both ADC as well as DAC and they are used when there is a need of converting signals either from analog to digital or digital to analog. Also the real world signals like..... Listed under: [Sound - Audio Projects](#)



1125. [Interfacing DHT11 with PIC16F877A for Temperature and Humidity Measurement](#) Temperature and Humidity measurement is often useful in many applications like Home Automation, Environment Monitoring, Weather station, etc. The most popularly used Temperature sensor next to LM35 is the DHT11, we have previously built many DHT11 Projects by interfacing it with Arduino, with Raspberry Pi and many other development boards. In this article, we..... Listed under: [Temperature Measurement Projects](#)



1126. [PIC IoT WG Development Board Review – What's new and How to Get Started with it](#) The three main parameters to consider while developing a portable IoT device would be Low Power Consumption, Wireless Connectivity, and Security. With exactly these three in mind, Microchip has launched a new development board called the PIC IoT WG. The board is powered by a 16-bit PIC..... Listed under: [Wireless Projects](#)



1127. [Gas Detection and PPM Measurement using PIC Microcontroller and MQ Gas Sensors](#) MQ series Gas sensors are very common types of sensors used in Gas Detectors to detect or measure certain types of Gases. These sensors are widely used in all Gas related devices like from simple Smoke Detectors to Industrial Air Quality Monitors. We have already used these MQ gas sensors..... Listed under: [Sensor - Transducer - Detector Projects](#)

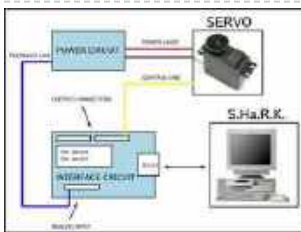

1128. [DIGITAL SERVO MOTORS INTERFACE CIRCUIT PIC16F877](#) Servo motor control unit to control two's. While the other one circuit pic16f877 16f876 circuits based on the communication with the computer via RS232 serial port is doing. KazirI backed by Assembly PCB software and schema files are made with eagle. Servo interface circuit can translate the..... Listed under: [Motor Projects](#)



1129. [WINAMP IR CONTROL CIRCUIT VISUALBASIC PIC16F627 RS232](#) Winamp can be used to control a variety of programs with some ready-made controls, but these controls are difficult to find compatible IR control circuit and control the problem disappears. IR transmitter circuit 16f627 microcontroller is based on the 6 button control receiver circuit MAX232..... Listed under: [Other Projects](#)













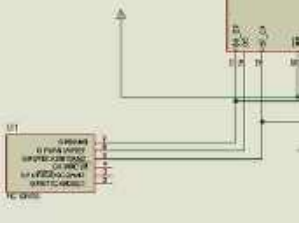

1130. [PIC16F627 RPM MEASUREMENT CPU FAN SPEED INDICATOR CIRCUIT](#) RPM measurement circuit PIC16F627 microcontroller based on the speed of the fan is displaying on the display. Software in assembly language prepared. PICMicro Project. measure the speed of the CPU's fan and display it on an application in Windows or you can simply go to..... Listed under: [Other Projects](#)

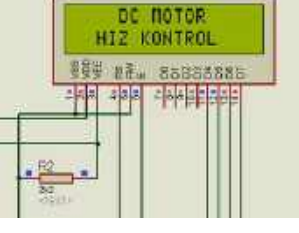





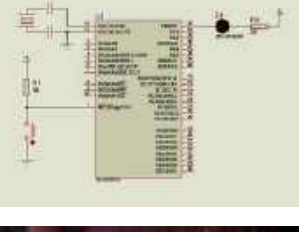







1131. [NOKIA3310 LCD PIC16F88 RESISTOR COLOR CODE CALCULATOR CIRCUIT](#) Our circuit commercially available 4-color carbon resistor color code itself accounts. As our circuit structure is quite simple . PIC16F88 as a material for Nokia 3310 keypad and LCD 4 x 3 consists of a few simple elements . Application to the study, the 12..... Listed under: [Phone Projects](#)

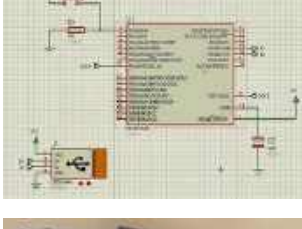

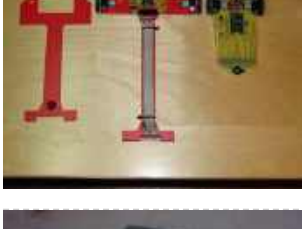





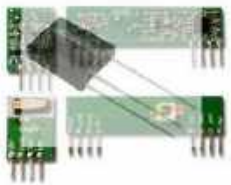

1132.  [PRECISION CNC MOTION CONTROL UNIT ENCODER, DRIVER INTERFACE PIC16F877](#) CNC control circuit PIC16F877 microcontroller used in the project's RS232 PC connection to all floors described separately (English) source: Assembly shared MPLAB IDE software. HIGH PRECISION CNC MOTION CONTROL This thesis focuses on the... Electronics Projects, Precision CNC Motion Control Unit Encoder, Driver Interface PIC16F877 "microchip projects, microcontroller..... Listed under: [CNC Machines Projects](#)
1133.  [DIGITAL PLL CONTROLLED FM RADIO CIRCUIT TEA5767 RECEIVER PIC16F628](#) Yes, let's recent project, a "Digital and PLL controlled FM Radio Receiver System" will give. Some of them may sound like a simple project. But a very open system development project. Currently on the... Electronics Projects, Digital PLL controlled FM Radio Circuit TEA5767 Receiver PIC16F628 "microchip projects, microcontroller..... Listed under: [Radio Projects](#)
1134.  [MIKROPASCAL MIKROBASIC MIKROC PROJECTS](#) Micro-Electronica product areas owned by the user that sent the company projects in various fields has many applications with source code in some simulations, there proteus isis. Mikropascal Micro C project FPGA programmer with... Electronics Projects, Mikropascal Mikrobasic MikroC Projects "dspic projects, microchip projects, microcontroller projects, pic16f84 projects,..... Listed under: [Other Projects](#)
1135.  [PIC MICROCONTROLLER-CONTROLLED ELECTRONIC PIANO PROJECT](#) Handmade in electronic piano project PIC16F690, PIC16F887 or PIC16F886. PIC microcontrollers can be used to connect to the legs of metal coins used as key microcontroller with ADC circuit 36 is used for touch-key... Electronics Projects, PIC Microcontroller-Controlled Electronic Piano Project "microchip projects, microcontroller projects, " Handmade in electronic piano..... Listed under: [Sound - Audio Projects](#)
1136.  [PIC18F2550 GPS CLOCK CIRCUIT BIG DISPLAY LS20031 SWORDFISHBASIC](#) PIC18F2550 microchip controller time clock circuit based on information from LS20031 GPS module is used as an indicator oversized 4 inch 7-segment display. GPS clock circuit source project owned Swordfish Basic code, libraries and... Electronics Projects, PIC18F2550 GPS Clock Circuit Big Display LS20031 SwordfishBasic "microchip projects, microcontroller projects,..... Listed under: [GPS Based Projects](#)
1137.  [PICBASIC PRO EXAMPLES PROTEUS ISIS CIRCUITS](#) PicBasic pro's work until about 200 microchip pic series circuits used in various micro controller pic basic pro proteus isis circuit simulations and resources. Bass, pbbp, hex codes are PicBasic samples; PicBasic sample list... Electronics Projects, Picbasic Pro Examples Proteus isis Circuits "microchip projects, microcontroller projects, pic16f628 projects,..... Listed under: [Development Board - Kits Projects](#)
1138.  [MICROCHIP TECHNICAL LIBRARY CD-ROM](#) "Microchip Technical Library CD-ROM" cd's with PIC microcontroller series information and i have a lot of practices PICmicro® Devices: Microchip is a leading supplier of 8-bit microcontrollers, with one of the broadest product offerings.... Electronics Projects, Microchip Technical Library CD-ROM "microchip projects, microcontroller projects, " "Microchip Technical Library CD-ROM"..... Listed under: [Video - Camera - Imaging Projects](#)
1139.  [WITHOUT USE ULTRASONIC SENSORS PARKING SENSOR CIRCUITS PIC12F675](#) Generally, parking sensors, ultrasonic sensors are used in the circuits used in the sensor circuit is shared very different handmade, fitted to the rear bumper of the car "capacitive proximity sensor" was called to... Electronics Projects, Without use Ultrasonic Sensors Parking Sensor Circuits PIC12f675 "microchip projects, microcontroller projects, "..... Listed under: [Sensor - Transducer - Detector Projects](#)
1140.  [PROTON IDE PROTEUS ISIS CIRCUITS EXAMPLE PROTON COMPILER](#) Proton was prepared with various case studies and proteus isis circuit simulations prepared by the example of the proton's a lot of fundamental issues. Thanks to the people who contributed to prepare. Proton ide... Electronics Projects, Proton ide Proteus isis Circuits Example Proton Compiler "microchip projects, microcontroller projects,..... Listed under: [Development Board - Kits Projects](#)
1141.  [PIC18F4550 PIC18F2550 USB PROJECT VISUALBASIC CIRCUIT](#) There are approximately 200 USB control software applications are generally prepared with the Visual Basic used PIC18F2550 microcontrollers, the PIC18F4550 codes written in C language. USB ADCs, etc. USB hidden. circuit has a lot... Electronics Projects, PIC18F4550 PIC18F2550 USB Project VisualBasic Circuit "microchip projects, microcontroller projects, pic18f2550 projects, "..... Listed under: [Interfacing\(USB - RS232 - I2c -ISP\) Projects](#)
1142.  [PIC16F877 16X16 LED MATRIX 74HC595 GRAPHIC DISPLAY PROJECT](#) Hello Electronics lovers. After a long hiatus, I wanted to write something again. In this article, software-serial basis (soft SPI) and still other applications I wrote using the name for a project I would... Electronics Projects, PIC16F877 16X16 LED Matrix 74HC595 Graphic Display Project "microchip projects, microcontroller projects,..... Listed under: [LED Projects](#)
1143.  [PIC18F4550 USB MARQUEE DISPLAY SCROLLING TEXT CIRCUIT LED VISUALBASIC](#) Marquee displaying the text that is sent over the USB port circuit i ... The program used to send text with visual basic source codes prepared and have built on the 8 x 32... Electronics Projects, PIC18F4550 USB Marquee Display Scrolling Text Circuit LED Visualbasic "microchip projects, microcontroller..... Listed under: [Interfacing\(USB - RS232 - I2c -ISP\) Projects](#)



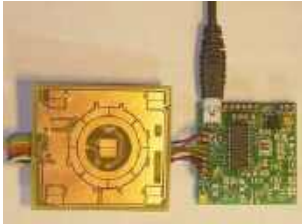









1144.  [GPS CIRCUIT BOATS COMPUTER PIC18F4550 MICROCONTROLLER](#) Generally known as PC Tools has prepared a project 😊 but siliconship in the boat's GPS system tracks the GPS module EM 408 and mikrodenetleric pic18f4550 usb connection to the circuit there also. 2X16... Electronics Projects, GPS Circuit Boats Computer PIC18F4550 Microcontroller "microchip projects, microcontroller projects, " Generally known..... Listed under: [GPS Based Projects](#)
1145.  [ELECTRONIC ANTI FOULING CIRCUIT BOATS FOR SAVERS ULTRASONIC PIC12F675](#) Electronic Antifouling Boat motor propeller parts of the body causing damage to the wood adhesive crustaceans, protozoa, parasites, and so on. who do harmful things such as ultrasonic signals out with a circuit... Electronics Projects, Electronic Anti fouling Circuit Boats for Savers Ultrasonic PIC12F675"microchip projects, microcontroller projects, "..... Listed under: [Motor Projects](#)
1146.  [RGB LED SHOW PIC12F675](#) Hello Electronic lovers that I have done it again with you in this article is an applications often wanted to share. In this study, using the PIC12F675 and 74HC595 Entegere be moved sequential RGB... Electronics Projects, RGB led show PIC12F675 "led projects, microchip projects, microcontroller projects, simple circuit..... Listed under: [LED Projects](#)
1147.  [PIC16F877 AIR RGB WRITING](#) Hello electronic lovers. This breaks my spare some time to compile my application I am trying to share with you. In this article I artificially everyone said it would offer air writing application. I... Electronics Projects,PIC16F877 Air RGB writing "microchip projects, microcontroller projects, pic16f877 projects, " Hello electronic..... Listed under: [LED Projects](#)
1148.  [PIC16F877A DC MOTOR CONTROL CIRCUIT LCD DISPLAY](#) 2x16 LCD display DC motor control application was based on PIC16F877 microcontroller proteus isis for the project and source code files (ano\_mtr.bas, ano\_mtr.hex) are available. PIC16f877A DC Motor Control Circuit LCD Display project Motor... Electronics Projects, PIC16f877A DC Motor Control Circuit LCD Display"microchip projects, microcontroller projects, pic16f877..... Listed under: [Motor Projects](#)
1149.  [TEMPERATURE FAN CONTROL LCD SCREEN TCN75 SENSOR PIC16F84A PICBASIC](#) The control circuit DS1621 application with which we have previously circuit ( PIC16F84A temperature fan control with LCD display -55 ° C / +125 ° C Picbasic ) TCN75 carried out with heat sensor... Electronics Projects, Temperature Fan Control LCD Screen TCN75 Sensor PIC16f84A PICBASIC "microchip projects, microcontroller..... Listed under: [Sensor - Transducer - Detector Projects](#)
1150.  [DIGITAL VOLTAGE PROBE PIC18F242](#) Hello In this article we will talk about Making Voltage Probe. First, let me explain what is the voltage probe. Voltage Probe, displays the amount of voltage at one point. In addition to a... Electronics Projects, Digital Voltage Probe PIC18F242 "microchip projects, microcontroller projects, " Hello In this article..... Listed under: [Development Board - Kits Projects](#)
1151.  [WEEKLY SCHEDULED WATERING FLOWERS CIRCUIT PICBASICPRO PIC16F876](#) I applied before the project @ ferhatyol friend revealed is a modified version of the project. 3 irrigation functions available in the program. Applications for pic16f876 microcontroller based on the 2 x 16 LCD...Electronics Projects, Weekly Scheduled Watering Flowers Circuit PicBasicPro PIC16f876 "microchip projects, microcontroller projects, pic16f876..... Listed under: [Development Board - Kits Projects](#)
1152.  [SUMO ROBOT PROJECT PIC16F877 CONTROL CIRCUIT L293D](#) Mini sumo robot design is very stylish robot pic16f877 microcontroller used in motor driver for the l293d kullanılmş software crafted with the C language. Mini densed very detailed all of the resources that are...Electronics Projects, Sumo Robot Project PIC16F877 Control Circuit L293D "microchip projects, microcontroller projects, pic16f877..... Listed under: [Robotics - Automation Projects](#)
1153.  [PIC16F877 CELL PHONE CALL DRUG USE MONITORING SYSTEM](#) Medical electronics, medical electronics interesting for people who are interested in a different application circuits during specified hours of the patient is receiving drug control if the relevant person is taking medication with mobile... Electronics Projects, PIC16F877 Cell Phone Call Drug Use Monitoring System"microchip projects, microcontroller projects,..... Listed under: [Phone Projects](#)
1154.  [SIMPLE LED LIGHT FLIP FLOP CIRCUIT HI TECH C EXAMPLE](#) The first Hi Tech C example is an example of the classic Hello world in C. Of course, this example is adapted to the world of the microcontroller. A 5V supply voltage for the... Electronics Projects, Simple Led Light Flip Flop Circuit Hi Tech C Example "hi tech..... Listed under: [LED Projects](#)
1155.  [RGB LED AIR WRITING VISUAL BASIC CCS C PIC16F877](#) According to the air a lot of writing applications with a superior visual basic application control program prepared with the required text, printed in specified rek. PIC16F877 microcontroller used in the air circuit writing... Electronics Projects, RGB LED Air Writing Visual Basic CCS C PIC16F877 "led projects, microchip..... Listed under: [LED Projects](#)

1156.  [PIC16F88 HUMIDITY CONTROL CIRCUIT SHT11](#) Seensierion company produces heat and moisture sensor SHT11 humidity measurement and control circuit is made with. The circuit can be used in many different purposes. For example, agricultural irrigation, soil humidity, according to the... Electronics Projects, PIC16F88 Humidity Control Circuit SHT11 "microchip projects, microcontroller projects, pic16f88 projects, picbasic..... Listed under: [Sensor - Transducer - Detector Projects](#)
1157.  [PIC10F200 MAUS MODIFICATION FOR THE GAME CONSTANTLY KEYPRESSES](#) To use the browser-based games, especially online custom modified maus and are selling a game for this circuit have keyboards I've heard has been placed into the online circuit mausmaus, depending on the... Electronics Projects, PIC10F200 Maus modification for the game constantly keypresses "microchip projects, microcontroller projects, simple..... Listed under: [Game - Entertainment Projects](#)
1158.  [OSCILLOSCOPE CIRCUIT WITH MAX492 PIC16F877 GRAPHIC LCD](#) Oscilloscope circuit project pic16f877-20 (20 MHz) microcontroller based on X 1, x 10 entries MAX492 Rail-to-Rail Op Amp input via grilimi 5v indicator as 128 x 64 glcd (PG12864) graphic lcd. Oscilloscope circuit power... Electronics Projects, Oscilloscope Circuit with MAX492 PIC16F877 Graphic LCD "microchip projects, microcontroller projects, pic16f877..... Listed under: [Development Board - Kits Projects](#)
1159.  [SECURITY ALARM CIRCUIT WITH PIC16F877 LCD](#) Security Alarm project 16f877 microcontroller Board 2x16 lcd indicator alarm circuit connected to the keypad on the necessary adjustments can be made. Circuit diagram pcb drawings, asm source, hex codes, alarm installation, lcd menu... Electronics Projects, Security Alarm Circuit with PIC16F877 LCD "microchip projects, microcontroller projects, pic16f877 projects, "..... Listed under: [Security - Safety Projects](#)
1160.  [LCD SWR METER CIRCUIT PIC16F877](#) SWR meter circuit pic16f877 microcontroller with lcd display displays the information on a printed circuit board with 2 x 16, schema diagrams in the C source code library files (adc. c, lcd8 c, swrm.... Electronics Projects, LCD SWR Meter Circuit PIC16F877 "microchip projects, microcontroller projects, pic16f877 projects, " SWR..... Listed under: [LCD Projects](#)
1161.  [LCD MENU INTERFACE PROJECT PIC18F2620 C18 NOKIA6100](#) PIC18F2620 Nokia 6100 lcd screen has a lot of Menu interface examples made with made with applications typically microchip PIC series popular in this application is a useful example of how to create a... Electronics Projects, LCD Menu interface Project PIC18F2620 C18 Nokia6100 "microchip projects, microcontroller projects, " PIC18F2620..... Listed under: [LCD Projects](#)
1162.  [PIC18F2550 USB HID PROJECT CSHARP CCS C](#) USB Hid project microcontroller used in Pic18f2550 software is a computer program designed with CCS C C sharp (Visual Studio 2010). All source code has been given a simple usb hid example also prepared... Electronics Projects, PIC18F2550 USB Hid project Csharp CCS C "microchip projects, microcontroller projects, pic18f2550..... Listed under: [Interfacing\(USB - RS232 - I2c -ISP\) Projects](#)
1163.  [ROBOTIC ARM PROJECT PIC16F877 CCS C VISUALBASIC COMPUTER-CONTROLLED](#) The robotic arm project and all resources are quite detailed PIC16F877 microcontroller in the control unit in the project has been kullal communicate with the computer is done via the RS232 serial port interface... Electronics Projects, Robotic ARM Project PIC16F877 CCS C VisualBasic Computer-controlled"microchip projects, microcontroller projects,..... Listed under: [Robotics - Automation Projects](#)
1164.  [PIC16F877 VERY FAST LINE FOLLOWING ROBOT PROJECTS ORANGUTAN B-328](#) Line following robot design in two different models, one that's "Baby Orangutan B-328 Robot" control module based on this on the module tb752a1 motor drive and ATMEGA48 or ATmega328 microcontroller's All materials SMD because... Electronics Projects, PIC16F877 Very Fast Line Following Robot Projects Orangutan B-328 "microchip projects, microcontroller..... Listed under: [Robotics - Automation Projects](#)
1165.  [PWM MOTOR CONTROL CIRCUIT HPWM PIC16F876 FREQUENCY MODULATED](#) Hello friends. Recent studies have adjustable frequency PWM motor control circuit that I want to share with you. Circuit is designed using pic16f876 and HPWM hardware. I used IRF540N MOSFETs in the payload. Mosfet... Electronics Projects, PWM Motor Control Circuit HPWM PIC16F876 Frequency Modulated"microchip projects, microcontroller projects,..... Listed under: [Motor Projects](#)
1166.  [433MHZ RF RELAY CONTROL CIRCUIT PIC16F628](#) RF relay control circuit PIC16F628 microcontroller used in the donor card 433MHz RF transceiver module with 8 buttons (433.92 MHz) command is sent to the recipient. Sadder still used in the RF receiver in... Electronics Projects, 433MHz RF relay control circuit pic16f628 "microchip projects, microcontroller projects, pic16f628 projects, "..... Listed under: [Development Board - Kits Projects](#)
1167.  [NID NIMH BATTERY CHARGING CIRCUIT PIC16F876 DELTA-PEAK](#) Control the battery charging circuit with PIC16F876 150 mA power in 6000 NiCd, NiMH batteries can be recharged circuit 50 to the power of 2 amps. pic output 2 MOSFETs (irf9540, smp60n) used battery... Electronics Projects, Nidc Nimh Battery Charging Circuit PIC16F876 Delta-Peak "battery charger circuit, microchip projects,..... Listed under: [Battery Projects](#)





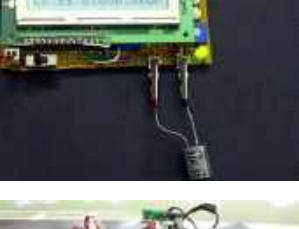
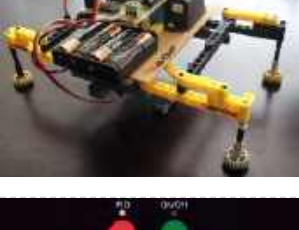





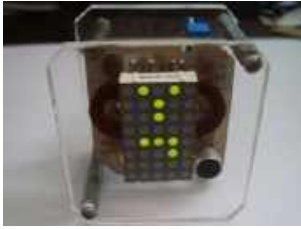



1168.  [SPEED CALCULATION CIRCUIT PIC18F4680 PICBASIC](#) Speed calculation circuit pic18f4680 used optionally pic18f4585 microcontroller used in the pic input signal FPS, MPH as the calculate and 4 × 16 LCD screen displays the software picbasic pro prepared by the source...Electronics Projects, Speed Calculation Circuit PIC18F4680 PicBasic "microchip projects, microcontroller projects, picbasic pro examples, "..... Listed under: [Calculator Projects](#)
1169.  [IR RF TRANSCEIVER CIRCUITS 8 CHANNEL REMOTE CONTROL](#) IR and RF transceiver circuits PIC16F628 microcontroller based on the software assembly prepared by the donor of the above değişiklik without just sittin 'with IR or RF controls can be made 8-channel and 4-channel...Electronics Projects, IR RF Transceiver Circuits 8 Channel Remote Control "microchip projects, microcontroller projects,..... Listed under: [Wireless Projects](#)
1170.  [SIMPLE AUTO ROBOT PIC16F628 H-BRIDGE MOTOR DRIVER CIRCUIT](#) Microchip PIC series microcontrollers prepared with a very robotic circuit's this circuit compared to the others a bit more simple, right, left controls the keys is done with the development of an open car... Electronics Projects, Simple Auto Robot PIC16F628 H-Bridge Motor Driver Circuit "microchip projects, microcontroller projects,..... Listed under: [Robotics - Automation Projects](#)
1171.  [PIC24F64GA002 VIDEO REMOTE ENVIRONMENTAL MONITORING ENC28J60 TCP/IP STACK](#) Custom designed hardware, presented using the eligible Microchip 16-bit MCU PIC24F64GA002, has been developed for the Microchip design contest to implement a video-based remote environmental monitoring system for use in critical areas. The... Electronics Projects, PIC24F64GA002 Video Remote Environmental Monitoring ENC28J60 TCP/IP stack "microchip projects, microcontroller projects, " Custom..... Listed under: [Video - Camera - Imaging Projects](#)
1172.  [PS2 MOUSE CONTROL PIC16F726 TEST CIRCUIT](#) Maus PS2 mouse designed to test a circuit according to the movements led display beautiful works of various shapes can be removed pic16f726 microcontroller circuit is realized with software ps2 prepared by assembly the... Electronics Projects, PS2 mouse control PIC16F726 test circuit "microchip projects, microcontroller projects, " Maus PS2..... Listed under: [chipKIT Projects](#)
1173.  [WINAMP TOUCH SENSOR INTERFACE AD7142ACPZ USB HID PIC18F2550](#) Winamp control made for an interesting project PIC18F2550 USB HID touch sensor card belonging to the pcb and information computer software ccs c source code eagle printed circuit board PCB diagram drawings, etc. All... Electronics Projects, Winamp Touch Sensor Interface AD7142ACPZ USB HID PIC18F2550"microchip projects, microcontroller projects,..... Listed under: [Sensor - Transducer - Detector Projects](#)
1174.  [LED PIXELS PIC24FJ64GA004 DYNAMIC TILE DISPLAY](#) The tiles are based on 2" square 8x8 LED displays. Each pixel in the display has a red and green LED. The LEDs are arranged in a matrix, with the red and green LEDs... Electronics Projects, LED pixels PIC24FJ64GA004 Dynamic Tile Display "microchip projects, microcontroller projects, " The tiles..... Listed under: [LED Projects](#)
1175.  [MICROCHIP PIC BLUETOOTH COMMUNICATION RN-41](#) Microchip PIC series microcontroller and Bluetooth module of the communication prepared for a sample module circuit eagle prepared by the PCB files and C programming examples are also over the mobile phone led, motor,... Electronics Projects, Microchip PIC Bluetooth Communication RN-41 "microchip projects, microcontroller projects, " Microchip PIC series..... Listed under: [Bluetooth Projects](#)
1176.  [RF IR REMOTE GARAGE DOOR CONTROL PROJECTS PIC16F628 PIC16F84](#) Garage door to check the projects prepared Microchip PIC series microcontrollers prepared by RF Modules with remote-controlled garage door control PIC16F628 (C language / udede rf module) IR infrared garage in control PIC16F84 (PBUH)... Electronics Projects, RF IR Remote Garage Door Control Projects PIC16F628 PIC16F84 "microchip projects, microcontroller..... Listed under: [Security - Safety Projects](#)
1177.  [EPSON CARTRIDGE RESET CIRCUIT PIC12F629](#) The printer of the original cartridge prices excessively expensive when soon cartridge refill, renovation works a lot in technical service began to be made even just engaged in this business there are places many...Electronics Projects, Epson Cartridge Reset Circuit PIC12F629 "microchip projects, microcontroller projects, " The printer of..... Listed under: [Development Board - Kits Projects](#)
1178.  [VIDEO SELECTOR CIRCUIT NJM2246 PIC16F84 LM1881](#) Video selector circuit 4 channels (NAV1, CAM1, CAM2, aux) inputted video signals via a single output giving as video selection buttons is done with circuit PIC16F84 microcontroller is carried out with help other integrated... Electronics Projects, Video selector circuit NJM2246 PIC16F84 LM1881 "microchip projects, microcontroller projects, pic16f84 projects, "..... Listed under: [Video - Camera - Imaging Projects](#)
1179.  [SOLAR BATTERY CHARGE CIRCUIT PIC16F88](#) 4 8-volt 500mA solar battery is charged using the 12 charging the battery charge and desars status (Charge and discharge control) that control PIC16F88 made using a circuit that require minimal power available in...Electronics Projects, Solar Battery Charge Circuit PIC16F88 "battery charger circuit, microchip projects, microcontroller projects,..... Listed under: [Battery Projects](#)











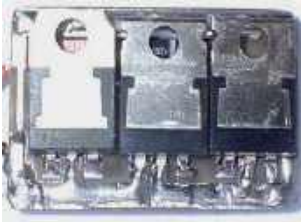



1180.  [FACE ROBOT PIC18F452 SERVO MOTOR CONTROL](#) Robot facial project PIC18F452 carried out with 5 servo motors by controlling the eyebrow, eye movements is provided circuit is more complex, but a breadboard based on the software in C language prepared by...Electronics Projects, Face Robot PIC18F452 Servo Motor Control "microchip projects, microcontroller projects, " Robot facial..... Listed under: [Robotics - Automation Projects](#)
- 
1181.  [RGB LED DRIVER CIRCUIT PIC12F629 PWM](#) RGB LED driver circuit can be controlled with PIC12F629 pic12f675 As an alternative, can be used PIC12F683 PIC GP0, GP1, GP2 STP36NF06 in output MOSFETs are driven by PWM technique internal oscillator of the...Electronics Projects, RGB LED Driver Circuit PIC12F629 PWM "led projects, microchip projects, microcontroller projects,..... Listed under: [LED Projects](#)
- 
1182.  [DOORBELL CIRCUIT 32 MELODY PIC16F876](#) Ringtones circuit very detailed crafted all the resources exist, particularly ringtone program for different projects can be useful, I'm not sure, but the sound codes with this program produced half of the asm, hex...Electronics Projects, Doorbell Circuit 32 Melody PIC16F876 "microchip projects, microcontroller projects, pic16f876 projects, " Ringtones..... Listed under: [Security - Safety Projects](#)
- 
1183.  [RINGTONES CIRCUIT PIC16F84A POLICE, AMBULANCE, MORSE SOUNDS](#) The melody has 5 audio circuit, made with pic16f84a American police sound ambulance siren, the alarm sound, the sound of Morse code, according to a previous 32 tune Melody a simpler design. due to...Electronics Projects, Ringtones Circuit PIC16F84A Police, Ambulance, Morse Sounds "microchip projects, microcontroller projects, pic16f84..... Listed under: [Sound - Audio Projects](#)
- 
1184.  [PIC18F4520 UNIPOLAR STEPPER MOTOR DRIVER CIRCUIT](#) Unipolar stepper motor driver circuit lcd graphics display control PIC18F4520 GLCD with WG12864B is provided. To the use of MOSFETs in the output irfz44 12-24 volts engines can take up to 4.5 amps. Take...Electronics Projects, PIC18F4520 Unipolar Stepper Motor Driver Circuit "microchip projects, microcontroller projects, " Unipolar stepper..... Listed under: [Motor Projects](#)
- 
1185.  [PIC18F2550 8 AXIS JOYSTICK FOR FLIGHT SIMULATOR](#) 8 axis joystick circuit flight simulator designed to be used on computers running simulator programs can work with flight simulator info because I have so I can not discuss, but the person concerned useful... Electronics Projects, PIC18F2550 8 axis joystick for Flight Simulator "microchip projects, microcontroller projects, pic18f2550..... Listed under: [Game - Entertainment Projects](#)
- 
1186.  [OPEN SOURCE USB OSCILLOSCOPE PROJECT FT245RL PIC16F690 CPLD](#) Software and hardware all resources are shared open source USB oscilloscope to implement the project's source C code (PIC16F690), CPLD Logic files, computer programs belonging to the codes (REALbasic) eagle schematics and PCB drawings... Electronics Projects, Open Source USB Oscilloscope Project FT245RL PIC16F690 CPLD "microchip projects, microcontroller projects, " ..... Listed under: [Interfacing\(USB - RS232 - I2c - ISP\) Projects](#)
- 
1187.  [COUNTER CIRCUITS JALV2 PIC16F628](#) Circuits PIC16F628 microcontrollers are based on the screening method using the program, the language is written with Jalv2. When the circuit board with resistors inside the blue frame on the right side, just because...Electronics Projects, Counter Circuits Jalv2 pic16f628 "microchip projects, microcontroller projects, pic16f628 projects, " Circuits PIC16F628 microcontrollers are..... Listed under: [Other Projects](#)
- 
1188.  [CAPACITY METER CIRCUIT PIC16F873A](#) Capacity meter circuit 5pF and 2600uf between the condenser capacity can gauge the pic16f873 microcontroller and a few passive element and the circuit formed values of 2 × 16 LCD screen is displayed on... Electronics Projects, Capacity meter circuit PIC16F873A "microchip projects, microcontroller projects, " Capacity meter circuit 5pF..... Listed under: [Metering - Instrument Projects](#)
- 
1189.  [RF ROBOT PROJECT PIC16F877](#) Robot project PIC16F877 microcontroller used ARX34 AND ATX34 RF modules and remote kontrol can be 3 servo mekanik run software ccs written in c receiver, transmitter section if our writers Aykut my brother "PIC16F628... Electronics Projects, RF Robot project PIC16F877 "microchip projects, microcontroller projects, pic16f877 projects, " Robot project PIC16F877 microcontroller..... Listed under: [Robotics - Automation Projects](#)
- 
1190.  [HEATER CONTROL CIRCUIT PID RTOS CCS C PIC18F2550](#) I think most computationally one of the subjects PID control on the web application also does not have much in this project PIC18F2550 microcontroller based on the PID temperature control made information on the...Electronics Projects, Heater Control Circuit PID Rtos CCS C PIC18F2550 "microchip projects, microcontroller projects,..... Listed under: [Temperature Measurement Projects](#)
- 
1191.  [LED CUBE CIRCUIT 5X5X5 PIC16F688](#) Led cube pic16f688 microcontroller used in the output driver circuit in the CA4016 LED (adjustable driver 16 channel flow ) is being integrated over. Prepared with PIC16F688 assembly source software. Asm, pcb printed circuit... Electronics Projects, Led Cube Circuit 5x5x5 pic16f688 "led projects, microchip projects, microcontroller projects, " Led..... Listed under: [LED Projects](#)

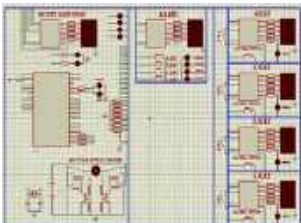

1192.  [TALKING ROBOT PROJECT MICROCHIP PIC24F16KA102](#) Based on previously prepared with CCS C Is a shared application software (Pic18f2455 PIC Tengu-speaking Robot CCS C) this application according to him is a good example of resource for more advanced pic24 series... Electronics Projects, Talking Robot Project Microchip PIC24F16KA102 "microchip projects, microcontroller projects, " Based on previously..... Listed under: [Robotics - Automation Projects](#)
1193.  [LED ANIMATION CIRCUIT PIC16F628](#) Led animated LED signs circuit , especially in circuit , made to be used in advertising applications PIC16F628 microcontroller is used in solid control software for PicBasic prepared by the PIC output MOSFETs (...Electronics Projects, Led Animation Circuit PIC16F628 "led projects, microchip projects, microcontroller projects, pic16f628 projects,..... Listed under: [LED Projects](#)
1194.  [PROGRAMMABLE AUTOMATION PIC16F87X ELECTRONIC PLC CIRCUIT](#) Several automation, control circuits I've seen, but so far so many features to an existing application the first time I met with microcontroller plc have done .. especially smart home alarm or for different... Electronics Projects, Programmable Automation PIC16F87X Electronic PLC Circuit "microchip projects, microcontroller projects, pic16f876 projects,..... Listed under: [Other Projects](#)
1195.  [EXAMPLE HALL EFFECT SENSOR PIC16F876 TACHOMETER CIRCUIT](#) Hall Effect Sensor for me an alien element, but especially microcontrollers people dealing with a lot of for the project may be used in one of the materials in the sample application pic16f876 based... Electronics Projects, Example Hall Effect Sensor PIC16F876 Tachometer Circuit "microchip projects, microcontroller projects, pic16f876..... Listed under: [Metering - Instrument Projects](#)
1196.  [LCD OSCILLOSCOPE CIRCUIT PROJECT PIC18F4520](#) Oscilloscope circuit PIC18F4520 microcontroller based on the indicators used for the 128x64 LCD PCB schematics and source code for the project given all menu.c, etc. glcd.c. in different projects such as files can be... Electronics Projects, LCD Oscilloscope Circuit Project PIC18F4520 "microchip projects, microcontroller projects, " Oscilloscope circuit PIC18F4520 microcontroller..... Listed under: [LCD Projects](#)
1197.  [PIC16F648 LED ANIMATED CLOCK CIRCUIT PICBASIC](#) Find the alarm clock circuit pcb design feature quite well around the display indicator is blinking LEDs with various effects PicBasic source code for ares proteus isis simulations and PCB files have. We also... Electronics Projects, PIC16F648 Led Animated Clock Circuit Picbasic "led projects, microchip projects, microcontroller projects,..... Listed under: [LED Projects](#)
1198.  [SIX-LEGGED BASIC STAMP2 SPIDER ROBOT PROJECT](#) Spider robot mechanically quite a detailed project control system based on pic microcontroller Basic Stamp 2 module is provided with circuit 7.2 Volt NiCad batteries in addition to the fed with the RC5 remote...Electronics Projects, Six-Legged Basic Stamp2 Spider Robot Project "microchip projects, microcontroller projects, " Spider robot mechanically..... Listed under: [Robotics - Automation Projects](#)
1199.  [8-CHANNEL RF RELAY CONTROL CIRCUIT RS232 PC PIC16F628](#) Relay control circuit is built on a computer via the rs232 port com pic16f628 microcontroller RF modules (433 mhz) can be controlled wirelessly with 8 relay with rs232 communication max232 project belongs to isis...Electronics Projects, 8-Channel RF Relay Control Circuit RS232 PC Pic16f628 "microchip projects, microcontroller projects,..... Listed under: [Development Board - Kits Projects](#)
1200.  [MICROCONTROLLER CONTROLLED VU METER CIRCUIT](#) KA2281 integrated circuits, LM3914, etc. According to the vu meter circuits with this circuit has been built on microcontroller circuit pic16f88 stereo really super 2x16 total 32 or mono 16 led, 40 can be... Electronics Projects, Microcontroller Controlled VU Meter Circuit "led projects, microchip projects, microcontroller projects, pic16f88..... Listed under: [LED Projects](#)
1201.  [ENJ28J60 TCP IP CONTROL CIRCUIT PIC18F67J60](#) Microcontroller controlled internet TCP IP applications typically used in Ethernet the Ethernet part of the ENJ28J60 control IC PIC18F67J60 control this part there is the project internally using the TCP-IP Stack, Microchip's internet page... Electronics Projects, ENJ28J60 TCP IP Control Circuit PIC18F67J60"microchip projects, microcontroller projects, " Microcontroller controlled..... Listed under: [Development Board - Kits Projects](#)
1202.  [PID MOTOR CONTROL CIRCUIT PIC18F2550 LABVIEW](#) PID motor control circuit based on Labview PID Motor Control microcontroller pic18f2550 Pic18f2550 program can be used with pic18f2550 rc2/ccp1 motor is controlled with kublör opto isolated port irf540 mosfet with motor control. PID... Electronics Projects, PID motor control circuit PIC18F2550 Labview"microchip projects, microcontroller projects, pic18f2550 projects, " ..... Listed under: [Motor Projects](#)
1203.  [BEAUTIFUL DECOR PIC12F629P RGB LED LAMP GLASS GLOBE](#) An application known as the bottles in the RGB DIY Mood vases made by placing different RGB led effect circuits, especially in the dark, they look very nice decors. The author has placed the... Electronics Projects, Beautiful Decor PIC12F629P RGB Led Lamp Glass Globe "microchip projects, microcontroller projects, "..... Listed under: [LED Projects](#)



1204.  [PWM MOTOR CONTROL CIRCUIT PIC12C509](#) Especially RC model, model to the application type has been designed motor control circuits printed circuit sizes too small ... different a few versions all there in the PIC12C509 mikrodenetleyic used PIC12C509 output is... Electronics Projects, PWM Motor Control Circuit PIC12C509 "microchip projects, microcontroller projects, motor control circuit,..... Listed under: [Motor Projects](#)
1205.  [PIC18F46K20 6-LEGGED ROBOT PROJECT](#) 6-Legged Robot Project PIC18F46K20 microcontroller and XBee modules based on two robot's body, legs and so on. parts such as printed circuit boards prepared with a plaque. Processing is easier for plaque PCBs are... Electronics Projects, PIC18F46K20 6-Legged Robot Project "microchip projects, microcontroller projects, " 6-Legged Robot Project PIC18F46K20..... Listed under: [Robotics - Automation Projects](#)
1206.  [USB INTERFACE CIRCUIT PIC18F2550 DELPHI](#) The project is written with delphi program microcontroller used USB interface Pic18f2550 control through a variety of commands on the card may be sent 4 channel button input, 4-channel led output, 2 x 16... Electronics Projects, USB Interface Circuit Pic18f2550 Delphi "microchip projects, microcontroller projects, pic18f2550 projects, " The..... Listed under: [Interfacing\(USB - RS232 - I2c -ISP\) Projects](#)
1207.  [COMPUTER CONTROLLED ROBOT PROJECT PIC16F877](#) Computer-controlled robot circuit special program is moving according to the shapes drawn on further action can be achieved by giving the coordinates instead of drawing circuit PIC16F877 microcontroller used robot communication between computers via... Electronics Projects, Computer Controlled Robot Project PIC16F877 "microchip projects, microcontroller projects, pic16f877 projects, " Computer-controlled..... Listed under: [Robotics - Automation Projects](#)
1208.  [8 CHANNEL 24 AMP TRIAC ANIMATION CIRCUIT PIC16F628](#) Hello Friends For a long time I did not do my share. I looked at my little library amusement park six months ago I prepared for bi TRIAC 8 Channel 24 saw the animated... Electronics Projects, 8 Channel 24 Amp Triac Animation Circuit PIC16F628 "microchip projects, microcontroller projects,..... Listed under: [Other Projects](#)
1209.  [40 CHANNEL ANIMATION LED CIRCUIT PIC18F452](#) Especially those used in LED signage is an enhanced version of the animation card has 40 outputs to the circuit board PIC18F452 microcontroller outputs 5 sadder 74ls595 irf540n MOSFETs are used in the multiplexed... Electronics Projects, 40 Channel Animation Led Circuit PIC18F452 "led projects, microchip projects, microcontroller projects,..... Listed under: [LED Projects](#)
1210.  [12V 100W LAMP WITH MAGNIFIER LENS DISCO EFFECT SYSTEM](#) Disco effects of the system control circuit PIC16F628 on board but the basic parts 12 volt 100-watt lamp and a magnifying lens (one in the header extend more than you;) PIC16F628 with stepper... Electronics Projects, 12V 100W Lamp With Magnifier Lens Disco Effect System "microchip projects, microcontroller projects,..... Listed under: [Other Projects](#)
1211.  [8X8 MATRIX LED SCROLLING TEXT CIRCUIT RS232 SENDING TEXT](#) 8x8px LED matrix marquee project pic16c52p microcontroller based on the circuit program prepared for the RS232 port negotiation make up to 128 characters font can send 8 x 8 TA23-11EW A – matrix screens... Electronics Projects, 8X8 Matrix LED Scrolling Text Circuit RS232 Sending Text "microchip projects, microcontroller..... Listed under: [LED Projects](#)
1212.  [4TH FLOOR ELEVATOR CONTROL CIRCUIT PIC16F877](#) Hello Friends . In high school I have done an elevator control circuit I want to share with you . I've designed a 4-story elevator . What floor is the elevator on each floor,... Electronics Projects, 4th Floor Elevator Control Circuit PIC16F877 "microchip projects, microcontroller projects, pic16f877 projects, "..... Listed under: [Development Board - Kits Projects](#)
1213.  [LINE FOLLOWING ROBOT CIRCUIT PIC12F508 MC68HC908QB8](#) Line following robot project, control of MC68HC908QB8 and PIC12F508 microcontrollers. Motor drive circuit used the L298. The system is complicated and cumbersome, but there's a different robot projects useful sections PIC12F508-American SFH506-36 IR receiver... Electronics Projects, Line Following Robot Circuit PIC12F508 MC68HC908QB8 "microchip projects, microcontroller projects, " Line following..... Listed under: [Robotics - Automation Projects](#)
1214.  [USC LCD COMPUTER CPU RAM INDICATOR PIC18F2550](#) For the first version of my Open Source Framework for USB Generic HID devices based on the PIC18F and Windows I made a USB interface for an LCD. Now that I've finished the second version of the library I thought it would be fun to enhance the LCD..... Listed under: [LCD Projects](#)
1215.  [ANTENNA ANALYZER CIRCUIT 31MHZ 1.3MHZ PIC16F873](#) 1.3 MHz 31MHz Antenna Analyzer circuit based on Pic16f873a microcontroller is able to measure between the frequencies of 1.3 MHz 31MHz 2 x 16 lcd on the frequency, omaj, swr, etc displays the information... Electronics Projects, Antenna Analyzer Circuit 31mhz 1.3MHz PIC16F873 "microchip projects, microcontroller projects, " 1.3 MHz..... Listed under: [Radio Projects](#)
1216. [433.92 MHZ RF RELAY CONTROL CIRCUIT PIC16F84](#) RF relay control circuit of the TWS-BS3 433.92 MHz rf transmitter and RWS-371-6 433.92 MHz rf receiver modules are used. RF relay control circuit of the receiver is used in all of the relays... Electronics Projects, 433.92 MHz RF relay



- control circuit PIC16F84 "microchip projects, microcontroller projects, pic16f84..... Listed under: [Radio Projects](#)
- 
1217.  [PIC16F690 BQ2018 BATTERY MONITOR CIRCUIT](#) Battery monitor PIC16F690 microcontroller based on the circuit current sensors on the floor BQ2018 enteree is used shunt resistance taken over by the value on the LCD display battery voltage, use percentage (battery, battery... Electronics Projects, PIC16F690 BQ2018 Battery Monitor Circuit "battery charger circuit, microchip projects, microcontroller projects, "..... Listed under: [Battery Projects](#)
- 
1218.  [MULTI FUNCTION RC5 REMOTE RGB LED CONTROL CIRCUIT PIC16F737](#) PIC16F737 RGB led control circuit based on microcontroller for remote control (RC5 Protocol) can work with different modes according to the color of the color change of the environment with the photo sensor a905013.... Electronics Projects, Multi function RC5 Remote RGB Led Control Circuit PIC16F737"microchip projects, microcontroller..... Listed under: [LED Projects](#)
- 
1219.  [ULTRASONIC SONAR RADAR ROBOT SAA1027 PIC18F2420 FT232](#) PIC18F2420 microcontroller board radar robot project for detection msu05 ultrasonic sensor module this module is used instead of the alternative ultra sonic by adding other modules or op amp amplifier circuits, 40 kHz ultrasonic... Electronics Projects, Ultrasonic Sonar Radar Robot SAA1027 PIC18F2420 FT232"microchip projects, microcontroller projects, " PIC18F2420..... Listed under: [Robotics - Automation Projects](#)
- 
1220.  [4 CHANNEL USB FAN CONTROL CIRCUIT PIC18F2550 LM335Z](#) Fan control circuit on a Board of Directors established the computer control program through Pic18f2550 microcontroller 4 channel can be set independently of the rotation speed of the fans is connected. Temperature sensor is... Electronics Projects, 4 Channel USB Fan Control Circuit PIC18F2550 LM335Z"microchip projects, microcontroller projects,..... Listed under: [Interfacing\(USB - RS232 - I2c -ISP\) Projects](#)
- 
1221.  [THERMOCOUPLE READING CIRCUIT PIC16F877](#) Thermocouple reading circuit PIC16F877 microcontroller based on the C source software, isis proteus simulation files and eagle diagram, printed circuit boards have drawings. Thermocouple voltage 0V (0 ° C) and 42.92mv (760 ° C)... Electronics Projects, Thermocouple Reading Circuit PIC16F877 "microchip projects, microcontroller projects, pic16f877 projects, " Thermocouple reading..... Listed under: [Temperature Measurement Projects](#)
- 
1222.  [TETRIS GAME CIRCUIT WITH PIC18F4520](#) A tetris game circuit to play Tetris costly software and hardware part of the business, but may be useful for the persons concerned could limp PIC18F4520 microcontroller circuit board on the transform matrix to...Electronics Projects, Tetris game circuit with PIC18F4520 "microchip projects, microcontroller projects, " A tetris game..... Listed under: [Game - Entertainment Projects](#)
- 
1223.  [VOLT AMP METER CIRCUIT PIC16F877](#) graphic lcd Volt amp meter circuit pic16f877 microcontroller Board, with the addition of the mc34063 dc-dc converter circuits and the I5973 used in the screenshot Im324 opamp GLCD MTG-12864B current and voltage information displaying.... Electronics Projects, Volt amp meter circuit PIC16F877 "microchip projects, microcontroller projects, pic16f877 projects, " graphic..... Listed under: [Metering - Instrument Projects](#)
- 
1224.  [USB THERMOMETER CIRCUIT CCS C PIC18F4550](#) Hi All You Guys. How long have you been working on CCS C. CCS will be able to see my level, so it is no longer something to do after arrival. In this article,... Electronics Projects, USB Thermometer Circuit CCS C PIC18F4550 "microchip projects, microcontroller projects, " Hi All..... Listed under: [Interfacing\(USB - RS232 - I2c -ISP\) Projects](#)
- 
1225.  [SD CARD SOUND RECORDING, PLAYBACK CIRCUIT PIC16F876A](#) SD/SDHC CARD SOUND RECORDER For SD with PETIT FAT File System see SD Bitmap project For sound playback with EEPROM see Doorbell The PIC16F876A's ADC digitizes the sound and store it in the SD or SDHC card. The firmware works for SD or SDHC cards only, for old SD..... Listed under: [Other Projects](#)
- 
1226.  [PIC32 SPECTRUM ANALYZER CIRCUIT TFT PIC24 PIC32 EXAMPLES](#) Spectrum Analyzer application PIC32 series from PIC32MX360F512L performed by imaging the 3.5 TFT LCD (16.7m. Color) 320X240 screen using software Microchip MPLAB C32 compiler prepared with ssd192x driver (SSD1928L Drivers) includes all the source... Electronics Projects, PIC32 Spectrum Analyzer Circuit TFT PIC24 PIC32 Examples "microchip projects, microcontroller projects, "..... Listed under: [LCD Projects](#)
- 
1227.  [BATTERY CHARGE CIRCUIT 12V 12AH](#) Lead Acid 12V 12AH battery charging circuit PIC16F876 microcontroller based on the 16f876 LEDs and battery level show and start, stop doing their work forces in the sight of the voltage, current, adjustable L200...Electronics Projects, Battery Charge Circuit 12V 12AH "battery charger circuit, microchip projects, microcontroller projects,..... Listed under: [Battery Projects](#)



- 1228.  [SCROLLING TEXT CIRCUIT LED MATRIX PIC16F628 74HC595](#) Marquee circuit built on the pic16f628 microcontroller circuit 8 X 80 LED matrix used LEDs is being prepared with the source software assembly circuits 74HC595. asm, cod, etc. have proteus isis simulation file. marquee... Electronics Projects, Scrolling Text Circuit LED Matrix PIC16F628 74HC595 "microchip projects, microcontroller projects, pic16f628..... Listed under: [LCD Projects](#)

---

- 1229.  [STEPPER MOTOR DRIVER WITH PIC16F628A L297 L298 CIRCUIT](#) Hello, friends. I have designed at the request of a teacher stepper motor driver circuit I want to share with you. System is going to start actually quite a few. But barely was able... Electronics Projects, Stepper Motor Driver with PIC16F628A L297 L298 Circuit "microchip projects, microcontroller projects,..... Listed under: [Motor Projects](#)

---

- 1230.  [MICROCHIP LED LIGHTING APPLICATIONS DESIGN GUIDE](#) Microchip produced by PIC microcontrollers, LED drivers, LED control ICs prepared for the sample application, designer notes .. Documents in the finest detail to given information (in English) source code and in the schemes's... Electronics Projects, Microchip LED Lighting Applications Design Guide "led projects, microchip projects, microcontroller projects, " ..... Listed under: [LED Projects](#)

---

- 1231.  [PICBASIC TFT TOUCH LCD PROJECT PIC16F628A SSD1289 ADS7843](#) Nowadays Touch TFT LCD control when a lot of people interested in microcontroller programming first thought the Pic18, Pic24, Pic32, ARM, etc ... but a little advanced microcontrollers and application uğraşırsa is a very... Electronics Projects, Picbasic TFT Touch LCD project PIC16F628A SSD1289 ADS7843"microchip projects, microcontroller projects,..... Listed under: [LCD Projects](#)

---

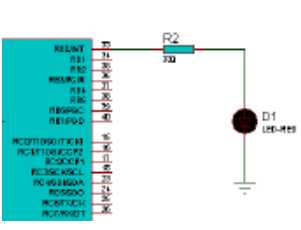
- 1232.  [CCS BUTTONS WITH LED CONTROL PIC16F877](#) CCS C simple application Buttons with LED Control circuit. This program B0 connected to the port LED connected to RA0 input is controlled by a button. Button-LED Control Simulation Test Proteus isis Schematic Button-LED... Electronics Projects, CCS Buttons with LED Control PIC16F877 "ccs c examples, microchip projects, microcontroller..... Listed under: [LED Projects](#)

---

- 1233.  [PIC16F628 12 CHANNEL RF RELAY CONTROL \(RR10 MODULE\)](#) 12 channel RF relay control circuit, the receiver and transmitter circuits built on 80 pic16f628a microcontroller.100 meters can be seamlessly used said outdoor area also more important aerial circuit, I don't know, but the... Electronics Projects, PIC16F628 12 Channel RF Relay Control (RR10 Module)"microchip projects, microcontroller projects,..... Listed under: [Development Board - Kits Projects](#)

---

- 1234.  [CCS LM35 TEMPERATURE SENSOR EXAMPLE WITH PIC16F877 LCD](#) PIC16F877 and LM35 Temperature Sensor Application simple CCSC Example PIC16F877 10-bit ADC isbe used. Read the ADC result and the information is transferred to the 2X16 LCD temperature value is printed LM35 Digital... Electronics Projects, CCS LM35 Temperature Sensor Example with PIC16F877 LCD "ccs c examples, microchip projects,..... Listed under: [Sensor - Transducer - Detector Projects](#)

---

- 1235.  [WALKING LED LIGHT CCS EXAMPLE PIC16F877](#) CCS C Walking LED Light using pic16f877 picmicro 8 LED Walking effect (As king rider led circuit) 100 ms delay Walking LED Circuit Schematic Walking LED Simulation Video Walking LED Light project proteus isis...Electronics Projects, Walking LED Light CCS Example PIC16F877 "ccs c examples, microchip projects, microcontroller..... Listed under: [LED Projects](#)

---

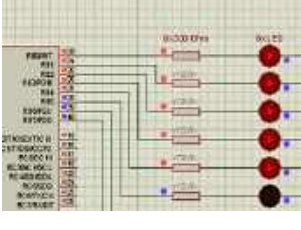
- 1236.  [CCS TOGGLE LED EXAMPLE PIC16F877](#) PIC16F877 Led Toggle CCS C This program connected to the port-B with 8 LED TOGGLE command 500 ms delay. order is flash LED the. CCS CToggle Led Schematic Diagram CCS CToggle Led Simulation Video...Electronics Projects, CCS Toggle Led Example PIC16F877 "ccs c examples, microchip projects, microcontroller projects,..... Listed under: [LED Projects](#)

---

- 1237.  [ENCODER, ANGLE MEASUREMENT CCS C PIC16F628 SAMPLE APPLICATION](#) Hi Friends, In this article I will mention the use of incremental enkoderlerin. These encoders with precisely how to angle measurement or position determination to do it. Market the Absolute (absolute) Encoders and Incremental... Electronics Projects, Encoder, angle measurement CCS C Pic16f628 sample application"microchip projects, microcontroller projects,..... Listed under: [Temperature Measurement Projects](#)

---

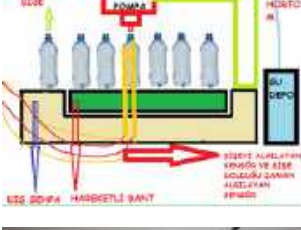
- 1238.  [PIC16F877 WITH BOTTLE FILLING SYSTEM](#) In this article, and a student friend, talk about his work with a bottle filling machine from the block schema system easier. Block diagram of bottle filling machine; 1: Tape engine starts to spin.... Electronics Projects,Pic16f877 With Bottle Filling System "microchip projects, microcontroller projects, pic16f877 projects, picbasic..... Listed under: [Other Projects](#)

---

- 1239.  [ELECTRONIC PIANO USING PIC MICROCONTROLLER \(PIC18F4550\)](#) Electronic piano circuit PCB printed circuit board drawing upon the Pic18f4550 microcontroller PIC has been a regular speaker on the card directly to number 2 in the pin of this RA0-Pic18f4550 AN0 pine bjt,...Electronics Projects, Electronic Piano Using PIC microcontroller (PIC18F4550) "microchip projects, microcontroller projects, " Electronic piano..... Listed under: [Sound - Audio Projects](#)

1240. [3X3X3 LED CUBE WITH PIC16F628 MICROCONTROLLER CIRCUIT](#) The market plenty of 4 x 4 x 4 led cube was made. I have made 3 x 3 x 3 led cube we also differ. Led cube in each layer is made up... Electronics Projects, 3x3x3 LED Cube with PIC16F628 microcontroller circuit"led





projects, microchip projects, microcontroller..... Listed under: [LED Projects](#)

1241.

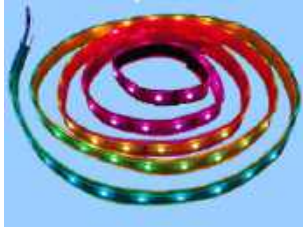

[PIC16F84 RGB LED STRIP ANIMATION CIRCUIT](#) PIC made with 8-channel moving light circuit. Combine some of this circuit outputs a rgb led Ribbon. the result satisfying. Three different buttons animation circuit. Which if you hold that the animation comes in...Electronics Projects, Pic16f84 RGB Led Strip Animation Circuit "led projects, microchip projects, microcontroller projects,..... Listed under: [LED Projects](#)

1242.

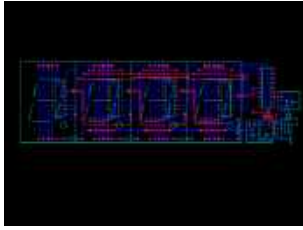

[WITH 4 DIGIT 7 SEGMENT TIME DS18B20 THERMOMETERS PIC16F628](#) Pic16f628 microcontroller-DS18B20 sensor clock thermometer based on the project has been very useful and detailed narration. Pic16f628-DS18B20 On the streets, the streets often started to see their side – instantly claiming your dependability or... Electronics Projects, With 4 Digit 7 Segment Time DS18B20 Thermometers pic16f628 "microchip projects, microcontroller..... Listed under: [Electronics News and Updates](#), [Temperature Measurement Projects](#)

1243.



[DISCO LIGHT EFFECTS SYSTEM WITH PIC16F876](#) It is a circuit for the circuit only show animation, colored lights and sound in proportion to the severity of a circuit to change the animation speed, also have created this. Usually known as... Electronics Projects, Disco Light Effects System with PIC16F876 "microchip projects, microcontroller projects, pic16f876 projects, "..... Listed under: [LCD Projects](#)

1244.



[PIC16F873 WITH LCD DISPLAY CALCULATOR CIRCUIT](#) Made with PIC16F873 microcontroller calculator project .. keypad buttons are used for standard HD44780 LCD assembly prepared with the software. Asm. Hex code there. Addition, subtraction, multiplication, division, decimal and hexadecimal number systems, computing... Electronics Projects, PIC16F873 with LCD Display Calculator Circuit "microchip projects, microcontroller projects, " Made with PIC16F873..... Listed under: [LCD Projects](#)

1245.



[CM8870 REMOTE DEVICE CONTROL VIA TELEPHONE DTMF PIC16F628](#) PIC16F628 microcontroller and DTMF CM8870 integrated circuits based on the 1, 2, 4 relay has versions with PCB printed circuit drawings are proteus software prepared by the Picbasic. Source code, the PCB according to... Electronics Projects, CM8870 Remote device control via telephone DTMF pic16f628 "microchip projects, microcontroller projects,..... Listed under: [Phone Projects](#)

1246.



[PIC16F88 LCD TACHOMETER CIRCUIT](#) PIC16F88Rpm analog voltage output that is, PWM signal so that only the output filter will depend on VDD. While there, press the switch, use the calibration and output voltage range equivalent to the rotation...Electronics Projects, PIC16F88 LCD Tachometer Circuit "microchip projects, microcontroller projects, pic16f88 projects, " PIC16F88Rpm analog..... Listed under: [LCD Projects](#)

1247.



[PIC16F876 CONTROL OF 8 SERVOS MOTOR 5 ANALOG CHANNELS I2C BUS](#) Microcontroller PIC16F876 4Mhz Controlled by the I2C slave module and analog servos technical report describes the design, both from the electronic point of view, as a computer control board for I2C bus 8 standard... Electronics Projects, PIC16F876 Control of 8 Servos Motor 5 Analog Channels I2C bus"microchip..... Listed under: [Motor Projects](#)

1248.



[ELECTRONIC DICE CIRCUIT WITH PIC12F629](#) the PIC12F629 on a microcontroller based electronic dice. electronic DICE with 14 LEDs dual membranes prepared for application software mikroc used to give random results when a button is pressed for 3 seconds if... Electronics Projects, Electronic Dice Circuit With PIC12F629 "microchip projects, microcontroller projects, " the PIC12F629 on a microcontroller..... Listed under: [LED Projects](#)

1249.



[COLOR DETECTION CIRCUIT PIC18F252](#) In the new version issued to 10 The number of colors, color identification and color separation feature was developed and added to a method for the sensitivity has been increased. Also feature full contact...Electronics Projects, Color Detection Circuit PIC18F252 "microchip projects, microcontroller projects, " In the new version..... Listed under: [Development Board - Kits Projects](#)

1250.



[HIGH VOLTAGE INSECT TRAP PIC16F675](#) Control circuit designed with microcontroller is done with high voltage to incapacitate an interesting insects pic16f675 a bug it won't run in normal operation for power saving high-voltage circuit on the PCB when solid... Electronics Projects, High Voltage Insect Trap PIC16F675 "microchip projects, microcontroller projects, " Control circuit designed..... Listed under: [Other Projects](#)

1251.



[CAR INFO PANEL WITH PIC16F873](#) In the car Frost Alarm (warning sound) , outdoor lamp, alarm, temperature, battery voltage, date, overcharging of information, such as a pic16f873 microcontroller which allows it to be displayed on a LCD display 4x20... Electronics Projects, Car Info Panel with PIC16F873 "microchip projects, microcontroller projects, " In the car Frost..... Listed under: [Car Projects](#)

1252.

[DSPIC30F2010 PWM MOTOR DRIVER CIRCUIT DRV8402](#) DRV8402 Motor Driver Circuit The main component is the microcontroller dsPIC30F2010, who for its activities needs outside of the power supply voltage also a source of accurate clock pulses. In order to achieve





the... Electronics Projects, dsPIC30F2010 PWM Motor Driver Circuit DRV8402 "dspic projects, microchip projects, microcontroller projects,..... Listed under: [Motor Projects](#)

1253.



[FLOWCODE EXAMPLES](#) Flowcode pic programming pic about the program in the form of flow diagrams of the easiest programs you can write easily in the market, still us is very simple, although it was touted as... Electronics Projects, Flowcode Examples "microchip projects, microcontroller projects, pwm circuits, " Flowcode pic programming pic about..... Listed under: [Other Projects](#)

1254.

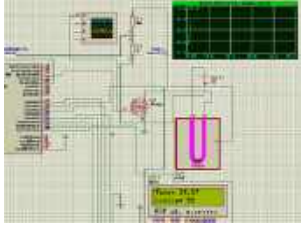

[CCS C APPLICATIONS PROTEUS SIMLATIONS](#) Previously shared CCS C sample application circuit code archive (C and Hex Isis) is a large archive with all source codes and proteus simulation circuits such as CCS C projects shared in the font.... Electronics Projects, CCS C Applications Proteus Simlations "microchip projects, microcontroller projects, pic16f876 projects, pic16f877..... Listed under: [Other Projects](#)

1255.

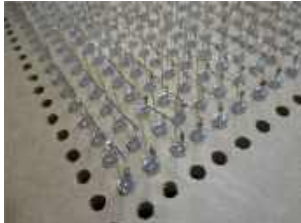

[4 PLAYER PONG GAME PIC18F4550](#) The PIC18f4550 microprocessor based pong game PIC18f4550 The first player to reach 20 points in the Pong Game wins the fireworks animation with leds. The PIC18f4550 works at 8MHz, the display is made up... Electronics Projects, 4 Player Pong Game PIC18f4550 "microchip projects, microcontroller projects, " The PIC18f4550 microprocessor based pong game PIC18f4550..... Listed under: [Game - Entertainment Projects](#)

1256.



[Digital Ammeter Circuit using PIC Microcontroller and ACS712](#) Measuring the voltage and current will always be helpful while making or debugging any electrical system. In this project we are going to make our own Digital Ammeter using PIC16F877A Microcontroller and current sensor ACS712-5A. This project can measure both AC and DC current with a..... Listed under: [Metering - Instrument Projects](#)

1257.



[Interfacing Ultrasonic Sensor HC-SR04 with PIC Microcontroller](#) For any project to come alive, we need to use sensors. Sensors acts as the eyes and ears for all embedded application, it helps the digital Microcontroller to understand what is actually happening in this real Analog world. In this tutorial we will be learning..... Listed under: [Interfacing\(USB - RS232 - I2c -ISP\) Projects](#)

1258.



[Interfacing GPS Module with PIC Microcontroller](#) GPS is the short-form of Global Positioning System. It is a system which provide accurate Altitude, Latitude, Longitude, UTC time and many more information, which are taken from 2, 3, 4 or more satellite. To read data from GPS, we need some Microcontroller and we..... Listed under: [Interfacing\(USB - RS232 - I2c -ISP\) Projects](#)

1259.

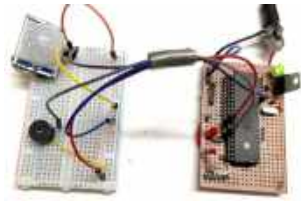

[Interfacing PIR Sensor with PIC Microcontroller](#) Today we are simple going to interface PIR with PIC Microcontroller PIC16F877A. In this circuit if some moving objects comes in the range of PIR sensor, the buzzer will start beeping. Material Required PicKit 3 PIR Sensor. PIC16F877A IC 40 - Pin IC holder Perf board 20..... Listed under: [Interfacing\(USB - RS232 - I2c -ISP\) Projects](#)

1260.

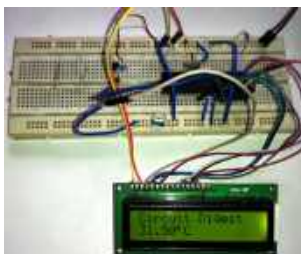

[Digital Thermometer using a PIC Microcontroller and DS18B20](#) Generally, the LM35 temperature sensor is used with microcontrollers to measure the temperature because it is cheap and easily available. But LM35 gives analog values and we need to convert them into digital using ADC (Analog to Digital Converter). But today we are using DS18B20 temperature..... Listed under: [Metering - Instrument Projects](#)

1261.



[Interfacing Joystick with PIC Microcontroller](#) Input devices play a vital role in any electronics projects. These input device help the user to interact with the digital world. An input device can be as simple as a push button or as complicated as a touch screen; it varies based on the..... Listed under: [Interfacing\(USB - RS232 - I2c -ISP\) Projects](#)

1262.



[Implementing serial communication in embedded systems](#) Serial communication was once the most widely used method of transferring data between computers. Many computing devices that you have used over time employ serial communication. Some of the terms associated with this type of data transfer are FTDI chip, COM interface, the RS232 protocol,..... Listed under: [Interfacing\(USB - RS232 - I2c -ISP\) Projects](#)

1263.

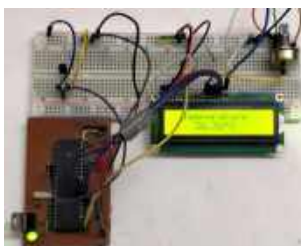

[Digital Thermometer using LM35 and PIC Microcontroller](#) In this tutorial, we are making a Digital Thermometer using PIC microcontroller and LM35 Temperature Sensor. In this project, we will sense the temperature using LM35 and display it on 16x2 LCD. LM35 Temperature Sensor is accurate and cheaper and doesn't require any external calibration. The output voltage..... Listed under: [Metering - Instrument Projects](#)

1264.

[Interfacing RTC Module \(DS3231\) with PIC Microcontroller: Digital Clock](#) Almost all embedded devices are designed to interact with the real world. They act as a bridge to communicate between the digital world and the real world. To make this process easier and efficient, the digital world would sometimes need to keep track of the..... Listed under: [Interfacing\(USB - RS232 - I2c -ISP\) Projects](#)



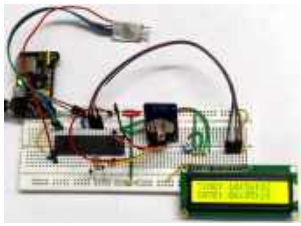

1265. [4x4 Matrix Keypad Interfacing with PIC Microcontroller](#) Keypads are widely used input devices being used in various electronics and embedded projects. They are used to take inputs in the form of numbers and alphabets, and feed the same into system for further processing. In this tutorial we are going to interface a 4x4 matrix keypad..... Listed under: [Interfacing\(USB - RS232 - I2c -ISP\) Projects](#)

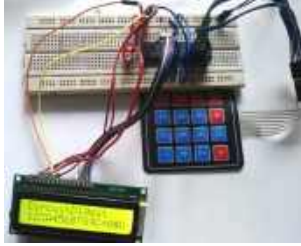

1266. [PIC to PIC Communication using RF Module](#) Hello everyone, Today in this project, we will interface RF Receiver and Transmitter module with PIC Microcontroller and communicate between two different pic microcontrollers wirelessly. In this project we will do following things:- We will use PIC16F877A for the Transmitter and PIC18F4520 for the Receiver section. We will interface Keypad..... Listed under: [Other Projects](#)



1267. [SPI Communication with PIC Microcontroller PIC16F877A](#) PIC Microcontrollers are a powerful platform provided by microchip for embedded projects; its versatile nature has enabled it to find ways into many applications and is yet to grow a lot. If you have been following our PIC tutorials then you would have noticed we have already..... Listed under: [Interfacing\(USB - RS232 - I2c -ISP\) Projects](#)

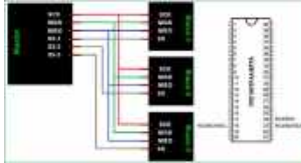

1268. [Relay Interfacing with PIC Microcontroller](#) In this project we will interface a Relay with PIC Microcontroller PIC16F877A. Relay is a mechanical device to control high voltage, high current appliances 'ON' or 'OFF' from lower voltage levels. Relay provides isolation between two voltage levels and it is generally use to control AC appliances. From..... Listed under: [Interfacing\(USB - RS232 - I2c -ISP\) Projects](#)



1269. [Interfacing 74HC595 Serial Shift Register with PIC Microcontroller](#) There are possibilities in embedded design where you do not have enough I/O pins available in your microcontroller. That can be due to any reason, may be your application needs multiple LEDs or you want to use multiple 7-segment displays, but you don't have required I/O..... Listed under: [Interfacing\(USB - RS232 - I2c -ISP\) Projects](#)

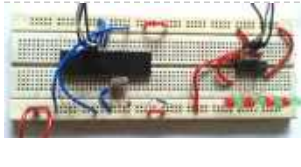

1270. [RFID Interfacing with PIC Microcontroller](#) RFID stands for Radio Frequency Identification. RFID module can read or write small amount of data into a Passive RFID tag, which can be used in identification process in various systems like Attendance system, security system, voting system etc. RFID is very convenient and easy technology. To read the Passive..... Listed under: [RFID - NFC Projects](#)



1271. [Thermal Printer interfacing with PIC16F877A](#) Thermal printer is often referred as receipt printer. It is widely used in restaurants, ATM, shops and many other places where receipts or bill is required. It is a cost-effective solution and very handy to use from the user's side as well as from the developer's..... Listed under: [Interfacing\(USB - RS232 - I2c -ISP\) Projects](#)

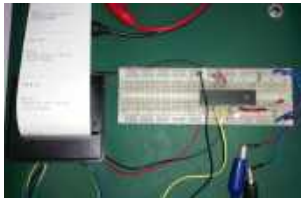

1272. [Heart Beat Monitoring using PIC Microcontroller and Pulse Sensor](#) Heart Beat rate is most important parameter in monitoring any person's health. In the modern era of wearable devices, there are lot of devices which can measure heartbeat, blood pressure, footsteps, calories burnt and lot of other things. These devices has pulse sensor inside them..... Listed under: [Medical - Health based Projects](#)



1273. [Generating PWM signals on GPIO pins of PIC Microcontroller](#) PWM signal generation is a vital tool in every embedded engineers arsenal, they come in very handy for lot of applications like controlling the position of servo motor, switching few power electronic ICs in converters/invertors and even for a simple LED brightness control. In PIC microcontrollers..... Listed under: [PWM Projects](#)

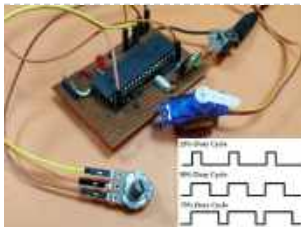

1274. [I2C COMMUNICATION WITH PIC MICROCONTROLLER](#) I love the Atmel AVR microcontrollers! Since building the Ghetto Development System described in this Instructable, I've had no end of fun experimenting with the AVR ATtiny2313 and the ATmega168 in particular. I even went so far as to write an Instructable on using switches as inputs,..... Listed under: [Sensor - Transducer - Detector Projects](#)

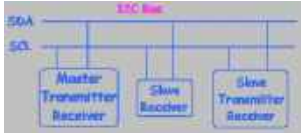

1275. [USE INPUT OUTPUT PORTS OF PIC18F452 MICROCONTROLLER](#) This guide hopefully will show you how to write C code that will allow you to read in an analog input (AI) value to your PIC microcontroller. I am using a PICkit 3 programmer with a PICkit 2 18-pin demo board. The microcontroller is a..... Listed under: [Development Board - Kits Projects](#), [Microcontroller Programmer Projects](#)

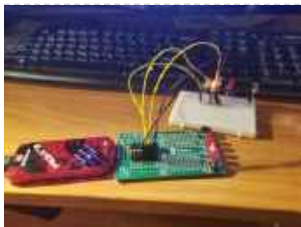

1276. [Bluetooth Controlled Robot using pic microcontroller](#) Today I came up with another engineering project for electronics and communication students, Android and Bluetooth controlled robot using PIC Microcontroller with object detecting capability. After installing MikroElectron's Robot Control App from Play Store you should be able to control the robot with your android phone/ tablet..... Listed under: [Bluetooth Projects](#), [Robotics - Automation Projects](#)



1277. [555 timer in different modes of operation with circuit diagram](#) This tutorial provides sample circuits to set up a 555 timer in monostable, astable, and bistable modes as well as an in depth discussion of how the 555 timer works and how to choose components to use with it. The



555 timer is a chip..... Listed under: [Development Board - Kits Projects](#)



1278. [Electric Energy Theft Intimation System Using PIC Microcontroller](#) In this instructable , I 'll show you how to build a PIC 16F917Microcontrollerprogramming circuit. This Microcontroller is a very nice Microcontroller chip form the famous chip manufacturer Microchip.This Microcontroller is easy to program and powerful to use.The photo above shows the programmer circuit after completion.Note:This circuit uses the serial port..... Listed under: [power - energy projects](#)

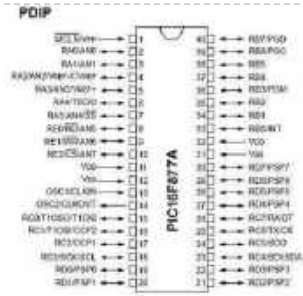

1279. [How to use input output ports 8051 microcontroller|LED blinking](#) PIC16F877A Pin out & Descriptions There are 5 ports that provide parallel I/O Interfaces to outside world PORTA, PORTB, PORTC, PORTD, PORTE Each port provides 8 bidirectional digital I/O lines which are connected to PIC16F877A pins provided that alternate functions are not selected on that..... Listed under: [LED Projects](#)



1280. [Interfacing Fingerprint Sensor with PIC Microcontroller](#) Finger Print Sensor, which we used to see in Sci-Fi movies a few years back, is now become very common to verify the identity of a person for various purposes. In present time we can see fingerprint-based systems everywhere in our daily life like for attendance..... Listed under: [Interfacing\(USB - RS232 - I2c -ISP\) Projects](#)

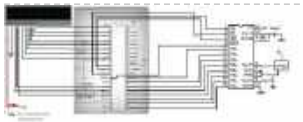

1281. [Prepaid Energy Meter with GSM Modem using pic microcontroller](#) In this tutorial will learn how to interface ADC0804(Analog to Digital Converter) with 8051(89c51,89c52) microcontroller. 8051 microcontrollers are pretty old and don't have a build in analog to digital converter in them unlike their new rivals(Arduino, Pic microcontroller and many more). Hence we can not..... Listed under: [Metering - Instrument Projects](#)

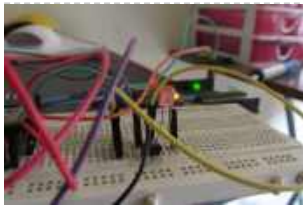

1282. [Esp8266 based home automation system using wifi](#) Esp8266 based home automation system using wifi It is also cheap and be used for making cool projects connected to the Internet .Learn how to make a simple IOT Project with it .The ESP8266 WiFi Module is a self contained SOC with integrated TCP/IP protocol..... Listed under: [Home Automation Projects](#), [Wifi - Wlan Projects](#)

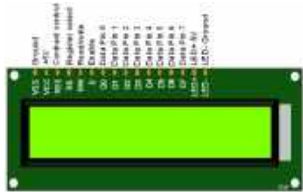

1283. [INTERFACING LCD WITH 8051 MIROCONTROLLER with code](#) Introduction LCDs (Liquid Crystal Displays) are used for displaying status or parameters in embedded systems. LCD 16x2 is 16 pin device which has 8 data pins (D0-D7) and 3 control pins (RS, RW, EN). The remaining 5 pins are for supply and backlight for the LCD..... Listed under: [LCD Projects](#)



1284. [DC MOTOR INTERFACING WITH 8051 MICROCONTROLLER](#) In this project, we will learn about L293D and L298N Motor Drivers and also about Interfacing DC Motor with 8051 Microcontroller with the help of both L293D and L298N. When we talk about controlling the robot, the first thing comes into the mind is controlling..... Listed under: [Motor Projects](#)

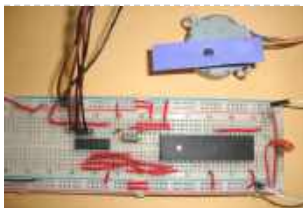

1285. [STEPPER MOTOR INTERFACING WITH 8051 MICROCONTROLLER](#) Stepper motor is brushless DC motor, which can be rotated in small angles, these angles are called steps. Generally stepper motor use 200 steps to complete 360 degree rotation, means its rotate 1.8 degree per step. Stepper motor used in many devices which needs precise..... Listed under: [Motor Projects](#)



1286. [How to Use "MikroC PRO for PIC" to Program PIC Microcontrollers](#) PIC microcontrollers are a very useful and versatile tool for use in many electronic projects. They are very inexpensive and easy to find. They are also very powerful and many are capable of speeds up to 64 MIPS using the internal oscillator block, about 16..... Listed under: [Microcontroller Programmer Projects](#)

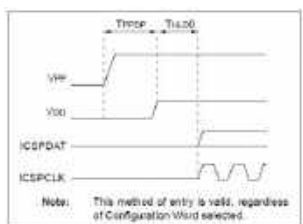









1287. [How to Use PICKit3 to upload code to pic microcontroller](#) For programming PIC microcontrollers we require a piece of hardware that can communicate between the computer and the microcontroller known as a programmer. There are several programmers available out there but we will be using PICKit3 for this example due to its versatility. One important note before we..... Listed under: [Microcontroller Programmer Projects](#)







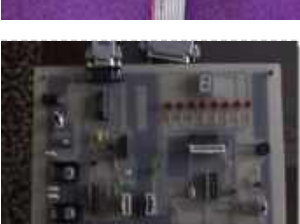
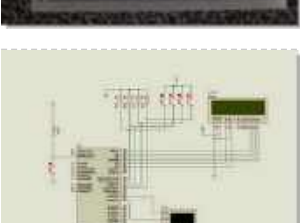

1288. [ESP8266 wifi module interfacing with pic microcontroller](#) Introduction ESP8266 module is low cost standalone wireless transceiver that can be used for end-point IoT developments. ESP8266 module enables internet connectivity to embedded applications. It uses TCP/UDP communication protocol to connect with server/client. To communicate with the ESP8266 module, the microcontroller needs to use..... Listed under: [Wifi - Wlan Projects](#)

1289. [EXPERIMENT BOARD FOR 40-PIN PIC-MICROCONTROLLERS DEVELOPMENT](#) Experiment with a lot of features for free pic development board PCB diagram drawing and painting has been completed state. 40 PIC series can be used for serial port interface (MAX232) button link



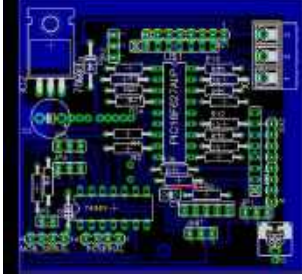

















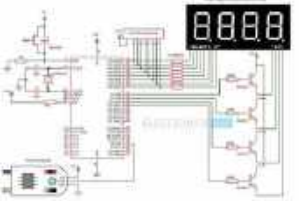



- 2... Electronics Projects, Experiment Board for 40-pin PIC-Microcontrollers Development "pic development board, " Experiment with a..... Listed under: [Development Board - Kits Projects](#)
- 
1290.  [PIC16F84 DEVELOPMENT BOARD PLAY-PIC](#) New to PIC programming a circuit that will be beneficial to your friends. Designed to work with PIC16F84. On the board buttons, LEDs and available in seven segments. Thus, when a trial programs çalıştırabilirsiniz.ayrı...Electronics Projects, PIC16F84 Development Board PLAY-PIC "pic development board, pic16f84 projects, " New to PIC..... Listed under: [Development Board - Kits Projects](#)
1291.  [PIC DEVELOPMENT BOARDS PIC16F84 PIC16F873](#) A PCB with firmware to exploit and test all the functions in this PIC microcontroller. The board features a LCD, keyboard, piezo sounder, Real Time Clock with backup power, I2C bus, potmeter for A/D... Electronics Projects, PIC Development Boards PIC16F84 PIC16F873 "avr development board, pic development board, pic16f84..... Listed under: [Development Board - Kits Projects](#)
1292.  [SIMPLE DSPIC EXPERIMENT DEVELOPMENT BOARD](#) Beginner level LEDs, buttons, analog input, 24Cxx EEPROM and serial communication with the PC I did try a little experiment where you can make your own set. Wishing to be helpful. Simple DSPIC Development...Electronics Projects, Simple DSPIC Experiment Development Board "dspic projects, pic development board, " Beginner level..... Listed under: [Development Board - Kits Projects](#)
1293.  [MICROCHIP PIC16F, PIC18F DEVELOPMENT BOARDS](#) This is a two-in-one PIC programmer and Experiment board for 40 pin PIC Micro devices.It easy to develop your program without insert/remove PIC micro.You just programming your code and then download to this board... Electronics Projects, Microchip PIC16F, PIC18F Development Boards "pic development board, " This is a two-in-one..... Listed under: [Development Board - Kits Projects](#)
1294.  [PROTOTYPING BOARD FOR PIC16F876 PROGRAMMER, EXPERIMENT](#) Prototyping Board for PIC 16F876 testing for PIC16F876 With this circuit board, you can program your microcontrollers from 16F87X family and the 18FXXX comprising 28 pins. this arrangement allows you to test its operation... Electronics Projects, Prototyping Board for PIC16F876 Programmer, Experiment "pic development board, pic16f876 projects, " Prototyping..... Listed under: [Development Board - Kits Projects](#)
1295.  [MICROCHIP PIC16F877 TESTING, EXPERIMENT BOARD](#) PIC16F877 Experiment board ACCEL P-CAD PCB PCB and schema files V14.00.3 asm code through the sample has been prepared by the addition You will find on this page all the elements to achieve a...Electronics Projects, Microchip PIC16F877 Testing, Experiment Board "pic development board, pic16f877 projects, " PIC16F877 Experiment board..... Listed under: [Development Board - Kits Projects](#)
1296.  [18-PIN MICROCHIP PIC EXPERIMENT BOARDS PROJECT](#) A Microchip PIC16F628 PIC16F648 PIC16F628 PIC16F84A PIC16F84A 18 pin PIC16F648 PIC `s simple handy series of experiment, development board 18-pin microcontrollers, and is the reason for this project. including the number 16F628, 16F628A, 16F648,... Electronics Projects, 18-Pin Microchip PIC Experiment Boards Project "pic development board, " A Microchip PIC16F628 PIC16F648 PIC16F628..... Listed under: [Development Board - Kits Projects](#)
1297.  [PIC16F84 PROGRAMMER EXPERIMENT BOARD](#) Useful simple PIC16F84 experiment and programming circuitry features the PORTB on the LED and seven-segment display ULN2803 connected with PORTA on the four buttons switch-controlled buzzer circuit DC 15 volt 500 mA power supply... Electronics Projects, PIC16F84 Programmer Experiment Board "pic development board, pic16f84 projects, " Useful simple PIC16F84 experiment and..... Listed under: [Development Board - Kits Projects](#)
1298.  [PIC16F877 PIC16F84 PROTEUS ISIS PICMICRO DEVELOPMENT BOARD SIMULATIONS](#) The code for 16F877 microcontroller 16f84 written ready for trial test circuit in Proteus ISIS additional 3 pcs 5 pcs assembly application (king rider, walking light flashers) have source <http://www.projearsivim.com/download/DeneyKarti.zip> Proteus isis Picmicro Development... Electronics Projects, PIC16F877 PIC16F84 Proteus isis Picmicro Development Board Simulations "pic development board, pic16f84..... Listed under: [Development Board - Kits Projects](#)
1299.  [PIC16F628 EXPERIMENT BOARD PROJECT](#) Picmicro for programming restart my first choice PIC16F628 was testing for Breadboard use challenging a simple test circuit was necessary did some research where the circuit I like a simple, cost, low beginners suitable... Electronics Projects, PIC16F628 Experiment Board Project "pic development board, pic16f628 projects, " Picmicro for programming..... Listed under: [Development Board - Kits Projects](#)
1300.  [MULTI-PURPOSE PICMICRO TEST BOARDS](#) 18 pin 28 pin 40 pin microcontroller series for a very pic usb rs232 multi-purpose development, test circuit ISCP has links with the on-board outputs can be connected upside additional apparatus has all the...Electronics Projects, Multi-Purpose Picmicro Test Boards "avr development board, pic development board, " 18 pin..... Listed under: [Development Board - Kits Projects](#)
1301. [DSPIC DEVELOPMENT BOARD](#) Try dspic30f6010 Microchip microcontroller development board on the UART (max233), can (mcp2551) and so on. find all entry and exit ports for the unit diagram and PCB design drawing eagle resources are also made... Electronics Projects, dsPIC

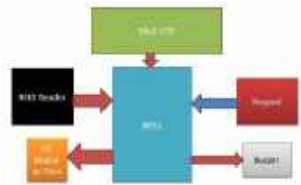

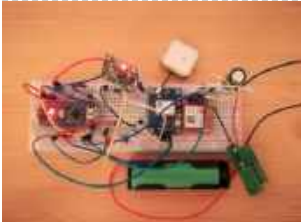
- Development Board "dspic projects, pic development board, " Try dspic30f6010 Microchip microcontroller..... Listed under: [Development Board - Kits Projects](#)
- 
1302.  [DEVELOPMENT BOARD PIC18F2550 PIC18F4550](#) PIC18F4550 and PIC18F2550 prepared for the experiment set of circuit than the regular seems simple, each chapter PCBs indicated on the layout also pretty good easily can be selected power source, LEDs, buttons, op...Electronics Projects, Development Board PIC18F2550 PIC18F4550 "pic development board, pic18f2550 projects, " PIC18F4550 and PIC18F2550 prepared for..... Listed under: [Development Board - Kits Projects](#)
1303.  [PIC18F4550 DEVELOPMENT BOARD AND PIC18F4550 EXAMPLES](#) PIC18F4550 for a simple handy trial development board and various application circuits are also circuits Eagle prepared by the PCB diagram drawings and PIC C language prepared by the software (MPLAB, C. Hex, Mcw,.... Electronics Projects, PIC18F4550 Development Board and PIC18F4550 Examples "avr development board, pic development board, "..... Listed under: [Development Board - Kits Projects](#)
1304.  [PIC18F4550 USB DEVELOPMENT BOARD PROJECT CCS C](#) Microchip PIC18F4550 PIC18F series microcontroller with a quality test kit to test the cottage will provide great convenience USB SD / MMC card slot so the LCD connection. 's. CCS C Software and protel...Electronics Projects, PIC18F4550 USB Development Board Project CCS C "pic development board, " Microchip PIC18F4550..... Listed under: [Interfacing\(USB - RS232 - I2c -ISP\) Projects](#)
1305.  [PIC18F2550 DEVELOPMENT BOARD CIRCUIT USB BOOTLOADER PCB](#) Unlike other applications that attempt PIC18F2550 development board "USB bootloader" option for the project for which you want to apply with the PIC18F2550 keep a circuit will provide great convenience for. PIC18F2550 Application Board... Electronics Projects, PIC18F2550 Development Board Circuit USB Bootloader PCB "pic development board, pic18f2550 projects, "..... Listed under: [Interfacing\(USB - RS232 - I2c -ISP\) Projects](#)
1306.  [PIC18F452, PIC16F877 SERIES MICROCONTROLLER EXPERIMENT BOARD](#) THIS IS THAT WOULD BE A SUCCESSFUL FOR BEGINNERS, NIGHTS OF BI: 4 ANALOG INPUTS 16 OUTSIDE BUFFERS RS232 IN BLACK WITH BLACK SUPPORT KROZ MCS ONBOARD LCD AND MORE THAN MANY BITCHES THE GOOD STORY IS BECAUSE YOU WANT TO MAKE A CUT 20 YEARS..... Listed under: [Development Board - Kits Projects](#)
1307.  [MULTI-FUNCTIONAL PICMICRO DEVELOPMENT BOARD \(BREADBOARD SUPPORTED\)](#) quite an advanced picmicro trial, testing, project development cycle a lot of functions all resources shared also the circuit for testing c language prepared test program at (pic\_board\_test.c) had the most excellent on the...Electronics Projects, Multi-functional PICmicro Development Board (Breadboard Supported) "avr development board, pic development board, "..... Listed under: [Development Board - Kits Projects](#)
1308.  [PIC18F2520 SD MMC DEVELOPMENT BOARD CIRCUIT](#) Try SD MMC card Pickit2 Clone pic18f2520 microcontroller based on the links in the section for the programmer's software exists in a source swordfish PIC18F2520 Development Board SD MMC Source: <http://digital-diy.com> SD MMC Development... Electronics Projects, PIC18F2520 SD MMC Development Board Circuit "pic development board, pic18f2550 projects, " Try..... Listed under: [Development Board - Kits Projects](#)
1309.  [PIC16F877 EXPERIMENT BOARD CIRCUIT PIC PROGRAMMING PIC TUTORIAL BOOK](#) A useful test development PIC16F877 circuit pcb printed circuit board design was quite nice small in size but has a lot of features. Serial RS232 connection, sensors, servos, PWM, I2C connector and so on.... Electronics Projects, PIC16F877 Experiment Board Circuit PIC Programming PIC Tutorial Book "pic development board,..... Listed under: [Development Board - Kits Projects](#)
1310.  [PIC16F874P PROJECT DEVELOPMENT TEST CIRCUIT](#) Try the card installed on board bred PIC16F874P test used in various robotics projects, etc. RS232 connection LCD output. features are also RS232, motor, LCD testing in the Software (asm, hex) there. "PICboard" module... Electronics Projects, PIC16F874P Project Development Test Circuit "pic development board, " Try the card installed..... Listed under: [Development Board - Kits Projects](#)
1311.  [USB DEVELOPMENT BOARD PIC16C765](#) Microcontrollers are not good with explanations will not do much about the circuit 😊 but prepared for the project with eagle pcb, diagrams, and Visual C + + asm prepared progrogra my PC (have... Electronics Projects, USB Development Board PIC16C765 "pic development board, " Microcontrollers are not good with..... Listed under: [Interfacing\(USB - RS232 - I2c -ISP\) Projects](#)
1312.  [ALL-IN-ONE MICROCONTROLLER EXPERIMENT PCB](#) A very well designed specifically for microcontroller projects useful test card can be used in many different kilflarda integrated standard input output ports that can be used for a long period of time, a... Electronics Projects, All-in-One Microcontroller Experiment PCB "pic development board, " A very well designed specifically..... Listed under: [Microcontroller Programmer Projects](#)

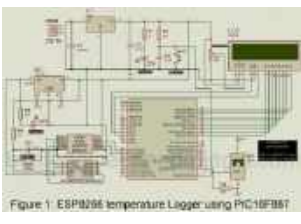

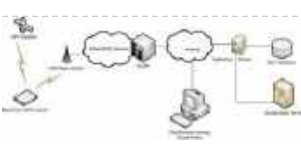
1313.  [PIC24 DEVELOPMENT BOARD BREAKOUT BOARD](#) development on the board64 pin pic24fj64ga006 pic24hj128gp506 the same leg connection with a PIC24 series microcontrollers available on the circuit inputs and outputs for connection and Pickit2 Clone header for used FTDI TTL 232R... Electronics Projects, PIC24 Development Board Breakout board "pic development board, " development on the board64..... Listed under: [Development Board - Kits Projects](#)
1314.  [OPEN SOURCE PROJECT DEVELOPMENT PLATFORM JALUINO JALV2 PIC18F4550](#) One Arduino named hunting, ca based on the development project carried out was very popular a lot like made additional modules say in every country a system used was Sebastien Lelong same job jalv2...Electronics Projects, Open Source Project Development Platform Jaluino Jalv2 PIC18F4550 "avr development board, pic..... Listed under: [Development Board - Kits Projects](#)
1315.  [MICROCHIP DEVELOPMENT TEST BOARD PIC18F452](#) Microchip microcontroller users is quite a useful experiment to work you need a Pic18f452 development Board this way, small-sized double-sided printed circuit board drawing a lot of property has been added ... max232 rs232... Electronics Projects, Microchip Development Test Board PIC18F452 "pic development board, " Microchip microcontroller users is..... Listed under: [Development Board - Kits Projects](#)
1316.  [8-40 PIN DIP ADAPTER FOR MICROCHIP PIC SERIES](#) Microchip PIC microcontroller to program the tar socket Series programlaycı ICSP programmer great convenience, but also do not have these facilities on a shared circuit DIP adapter between 8 .... 40 Pin PIC microcontroller... Electronics Projects, 8-40 Pin DIP Adapter for Microchip PIC Series "pic development board, " Microchip..... Listed under: [How To - DIY - Projects](#)
1317.  [GSM based home devices control system](#) The project aims at a system allowing user to control home based appliances through Sms along with acknowledgements. Here user need not switch home appliances on and off manually. Our system allows user to operate these devices through sms, also the status weather the device..... Listed under: [Phone Projects](#)
1318.  [HUMANOID robotic ARM using pic microcontroller](#) From the assembly line of automobile manufacturing industries to the telesurgery robots in space, Robotic Arms are to be found everywhere. The mechanisms of these robots are similar to a human which can be programmed for similar function and increased capabilities. They can be used..... Listed under: [Robotics - Automation Projects](#)
1319.  [Electronic lock using pic microcontroller](#) Security is a prime concern in our day-today life. Everyone wants to be as much secure as possible. An access control for doors forms a vital link in a security chain. The microcontroller based digital lock for Doors is an access control system that allows..... Listed under: [LCD Projects](#)
1320.  [Digital multimeter circuit using pic microcontroller](#) Hello everyone, thank you for checking out my first Instructable. I have enjoyed seeing your creations over the years and love what all of you are contributing. This project is a spin off of one that I recently saw here and I need to give a shout out to Bot1398 because..... Listed under: [LCD Projects](#)
1321.  [What is Led matrix? Types of Dot matrix display with working](#) Interfacing on a 8x8 dot matrix can be fun and is easy to play with, so let's get straight into it! Step 1: What You Will Need: AT89C51 MICRCONTROLLER 8X8 DOT MATRIX A DEVELOPMENT BOARD OR DOT MATRIX MODULE Step 2: Principles You Need to..... Listed under: [LED Projects](#)
1322.  [Receive sms gsm module using pic microcontroller](#) GSM modules are fascinating to use especially when our project requires remote access. These modules could make all actions that our normal mobile phone could do, like making/receiving a call, sending/receiving a SMS, connecting to internet using GPRS etc. You can also connect a normal microphone..... Listed under: [Phone Projects](#)
1323.  [contactless tachometer circuit with code](#) A Tachometer is a device which measures the speed of a rotating object like an electric motor or a crank shaft of a vehicle engine. Speed of an electric motor is determined by the number of revolutions made by the motor in one minute. In..... Listed under: [Motor Projects](#)
1324.  [password based circuit breaker using pic microcontroller](#) A circuit breaker is an automatically operated electrical switch designed to protect an electrical circuit from damage caused by overload or short circuit. Its basic function is to detect a fault condition and interrupt current flow. Unlike a fuse, which operates once and then must be..... Listed under: [Security - Safety Projects](#)

1325.  [Tv remote controlled home automation system](#) In this project, we are using IR based wireless communication for controlling home appliances. In this project, Arduino is used for controlling whole the process. We send some commands to the controlling system by using IR TV/DVD/MP3 remote for controlling AC home appliances. After receiving..... Listed under: [Home Automation Projects](#)
1326.  [wireless electronics notice board using gsm with code](#) Wireless notice board is very selective term for this project, as it has a very wide scope rather than just being a simple notice board. First we should understand the purpose of this project, in this system we can display a message or notice to..... Listed under: [Wireless Projects](#)
1327.  [parking management system project using pic microcontroller](#) In this tutorial, we will discuss the parking management system project using pic microcontroller that how we can manage our parking with the pic microcontroller. Items used in this project: Hardware components Res Thin Film 10K Ohm 1% 3/5W  $\pm 50\text{ppm}/^\circ\text{C}$  Conformal AXL Thru-Hole Ammo Pack..... Listed under: [LED Projects](#)
1328.  [RFID based electronic lock using pic microcontroller](#) [embed]https://youtu.be/eb15tMjaxyQ[/embed] In these days we're here with our subsequent assignment that is RFID and keypad primarily based security machine. This assignment is implemented by means of the use of 8051. often we are able to see RFID tags or card in metro teach when we're..... Listed under: [LCD Projects](#), [Security - Safety Projects](#)
1329.  [Three phase voltage measurement using pic microcontroller](#) In our day-to-day life, we consume electrical energy for various purposes such as for powering electrical appliances, gadgets, devices, machines, and so on. So, it is essential to measure the amount of power consumed to generate electricity bill which is usually done by energy meters..... Listed under: [Microcontroller Programmer Projects](#)
1330.  [Vehicle Tracking System Through GPS-GSM Modules](#) So you have got a GSM module lying around like me? Also a GPS-tracker? We think the same! In this instructables, I will try to guide you how to accomplish your goal from a newbie's perspective. As I had no previous electrical engineering knowledge (to..... Listed under: [Car Projects](#)
1331.  [accelerometer Based Hand Gesture Controlled Robot using Xbee](#) With this robot, you control everything with your hand, even the robotic arm! The hand gestures can be programmed differently. Long range with Xbee communication! Step 1: Parts Needed Arduino Uno x2 - [http://store.arduino.cc/index.php?main\\_page=produc...](http://store.arduino.cc/index.php?main_page=produc...) Xbee S2 x2 - <https://www.sparkfun.com/products/11217> Xbee shield for Arduino Uno x2 - <https://www.sparkfun.com/products/12847> Xbee..... Listed under: [Robotics - Automation Projects](#)
1332.  [Efficient Energy Management System with Smart Grid](#) In this post we will discuss Efficient Energy Management System with Smart Grid. Smart Energy Management is the system, which uses communication and control centre for simplifying and upgrading the power system. In this paper, different types of energy management systems are discussed and also..... Listed under: [power - energy projects](#)
1333.  [IOT Based Temperature data logger using esp8266 and pic microcontroller](#) In this post we will learn IOT based temperature data logger using esp8266 and pic microcontroller: The project ESP8266 Temperature Logger using PIC16F887 is build up using PIC16F887 microcontroller (MCU), ESP8266 WiFi module and a ThingSpeak API. Previously, we posted Arduino and ESP8266 based webserver and..... Listed under: [Temperature Measurement Projects](#)
1334.  [Home security system using PIR sensor and GSM module](#) In this project, we are going to develop a PIR sensor and GSM based home security system. This project is developed using 8051 microcontroller. It can be used to detect any intrusion in houses and offices and send the alerts on cell phones. Let us know..... Listed under: [Security - Safety Projects](#)
1335.  [Display GPS Co-ordinates on LCD using pic microcontroller](#) This project describes how you can build a mobile real time GPS tracker with integrated Google Maps. I began this project mainly to see if I can integrate all the different pieces of hardware and software to make a workable solution, and it took some..... Listed under: [LCD Projects](#)
1336.  [GPS based speedometer using pic microcontroller](#) My company car that I normally drive tends to have a "small" problems from time to time, the speedometer fall to 0 Km/h when driving (after some time it resumes again). Normally this is not a big issue since if you know how to drive..... Listed under: [Wireless Projects](#)
1337. [gsm based dc motor speed control using pic microcontroller](#) Hey friends this is my 3rd year BE project " Speed control of DC motor"which i could like to share with you .In this you will learn how to interface LCD,hex keypad and motor .The code is written in assembly to simplify I have..... Listed under: [Motor Projects](#)



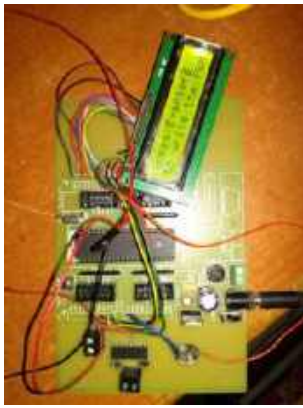

1338. [XBee Based Temperature and Gas Monitoring System Using Pic Microcontroller](#) Air pollution has become a common phenomenon everywhere. Specially in the urban areas, air pollution is a real-life problem. In the urban areas, the increased number of petrol and diesel vehicles and the presence of industrial areas at the outskirts of the major cities are..... Listed under: [Temperature Measurement Projects](#)

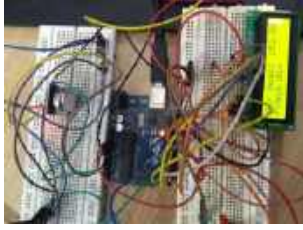

1339. [DsPIC33F microcontroller based pure sine wave inverter](#) In this post we will briefly discuss DsPIC33F microcontroller based pure sine wave inverter. The majority of the technological devices used with the development of the technology use the network voltage (220V-50Hz). Conversion must be done to obtain the mains voltage from the DC storage..... Listed under: [Wifi - Wlan Projects](#)



1340. [MPPT Based Charge Controller Using Pic Microcontroller](#) In this post we will briefly discuss about MPPT Based Charge Controller Using Pic Microcontroller. Photovoltaic is one of the renewable energy resources that recently has become broader in nowadays technology. The electricity generations of photovoltaic (PV) panels are strongly related with insolation and temperature..... Listed under: [Phone Projects](#)



1341. [Heart beat pulse sensor interfacing with pic microcontroller](#) Heart Beat rate is most important parameter in monitoring any person's health. In the modern era of wearable devices, there are lot of devices which can measure heartbeat, blood pressure, footsteps, calories burnt and lot of other things. These devices has pulse sensor inside them..... Listed under: [Sensor - Transducer - Detector Projects](#)

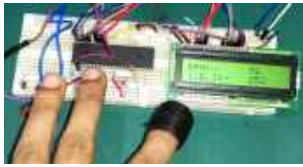

1342. [How to display 5x8 and 5x10 size font characters on 16x2 lcd with 8-bit microcontrollers](#) Character lcds can display character of font size 5x8 and 5x10. In 5xn, 5 represents number of coulombs and N represents number of rows. Character lcd's especially which are controlled by Hitachi HD44780 controller can display 5x8 and 5x10 size font character. Some lcd's can..... Listed under: [Microcontroller Programmer Projects](#)

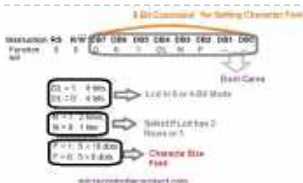

1343. [Interfacing LM35 temperature sensor with PIC18F4550 microcontroller](#) Interfacing PIC18F4550 with LM35 This small topic shows the circuit diagram and CCS C code of the interfacing of LM35 temperature sensor with PIC18F4550 microcontroller. The LM35 temperature sensor is three pin device (VCC, OUT and GND) with an output voltage linearly related to Centigrade..... Listed under: [Temperature Measurement Projects](#)



1344. [Wave player using PIC18F4550 microcontroller](#) Making an audio player (.wav files) using PIC microcontroller is not complicated especially when the MCU has a PWM module. This topic shows how to build an audio player using PIC18F4550 microcontroller where the file is stored in an SD card with FAT16 or..... Listed under: [Sound - Audio Projects](#)

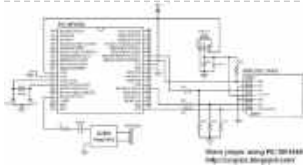

1345. [Remote controlled USB mouse using PIC18F4550](#) Building a USB mouse using PIC18F4550 microcontroller and CCS C compiler is easy as shown in the link below: USB Mouse using PIC18F4550 microcontroller Also, it is not hard to add an infrared remote control to the previous USB project. This post shows how did..... Listed under: [Interfacing\(USB - RS232 - I2c -ISP\) Projects](#)



1346. [MMC/SD Card raw data read with PIC16F887 microcontroller](#) Interfacing MMC/SD card with PIC16F887 This small example shows how to read SD card raw data (bytes, sectors ...). SD card raw data means that there is no use of system files like FAT16 or FAT32. Serial monitor is used to display the data after..... Listed under: [Phone Projects](#)

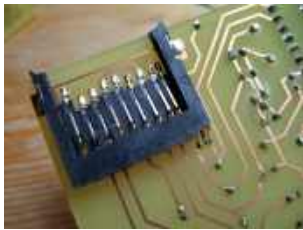







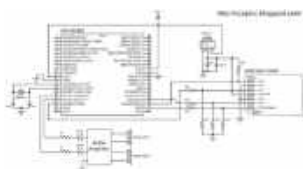

1347. [Read text files from FAT16 SD card with PIC16F887](#) Interfacing PIC16F887 with FAT16 SD card After reading raw data (bytes and sectors) from SD card, now I'm going to use FAT16 file system to read and print text file located in 2 GB SD card. Read SD card raw data topic: MMC/SD Card raw..... Listed under: [Phone Projects](#)

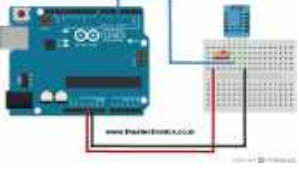

1348. [Wave audio player using PIC16F887 microcontroller](#) This small project shows how to make a simple wave audio player using PIC16F887 microcontroller and SD card. The WAV audio file used in this project is 8000 Hz, 8-bit stereo (2 channels). Hardware Required: PIC16F887 microcontroller SD card (formatted with FAT16 or FAT32..... Listed under: [Sound - Audio Projects](#)

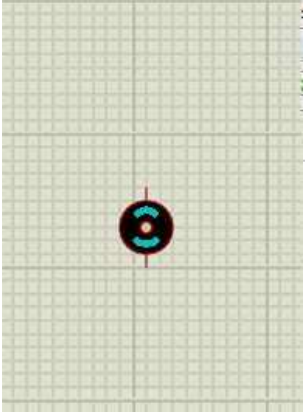

1349.  [DC motor control with PIC16F84A and L293D](#) Low power DC motors can be easily controlled with half H-bridge IC L293D. This IC is 16-pin IC which can control 2 motors in both directions. This topic shows how to control DC motor speed and direction with PIC16F84A and L293D motor drive integrated circuit..... Listed under: [Motor Projects](#)
- 
1350.  [PIC16F84A + DHT11 Proteus simulation](#) Interfacing PIC16F84A microcontroller with DHT11(RHT01) sensor This topic shows how to interface DHT11 (RHT01) digital relative humidity and temperature sensor with PIC16F84A microcontroller, and how to simulate this interfacing using Proteus. Note that for the simulation Proteus version should be 8.1 or higher. With these..... Listed under: [Sensor - Transducer - Detector Projects](#)
- 
1351.  [PIC16F84A + DHT22\(AM2302, RHT03\) sensor Proteus simulation](#) DHT22 Proteus simulation This topic shows how to interface DHT22 (AM2302, RHT03) digital relative humidity and temperature sensor with PIC16F84A microcontroller, and how to simulate this interfacing using Proteus. Note that for the simulation Proteus version should be 8.1 or higher. With these versions there..... Listed under: [Sensor - Transducer - Detector Projects](#)
- 
1352.  [Interfacing PIC16F84A with SD card](#) This topic shows a simple interfacing of 2 GB micro SD card with PIC16F84A microcontroller. I used the PIC16F84A to read the SD card raw data which doesn't require a microcontroller with high RAM or ROM. In this interfacing I used software SPI because the..... Listed under: [Phone Projects](#)
- 
1353.  [DHT11 Interfacing with PIC12F1822 microcontroller](#) In this blog there are some topics talking about the DHT11 relative humidity and temperature sensor and how to interface it with different types of PIC microcontrollers. The datasheet of the DHT11 sensor shows its characteristics and how it works. Also the following topic shows..... Listed under: [Sensor - Transducer - Detector Projects](#)
- 
1354.  [Getting Started With Proteus](#) Hello readers, today's post is the first regular post on Proteus tutorial. In today's tutorial, I am gonna share Getting Started with Proteus. Today's tutorial is for beginners who don't have much knowledge of Proteus but wants to start working with it. We don't design..... Listed under: [power - energy projects](#)
- 
1355.  [IR Remote control transmitter and receiver using PIC12F1822 microcontroller](#) 5-Channel IR remote control system using PIC microcontroller This topic shows how to make a simple infrared (IR) remote control system using the microcontroller PIC12F1822. This IR system has two circuits as known: IR transmitter circuit and IR receiver circuit. Both circuit based on the..... Listed under: [Other Projects](#)
- 
1356.  [Circuit Designing of LCD with PIC](#) Hello friends, hope you all are fine and enjoying good health. Today I am posting the next part of Proteus tutorial which is Interfacing of LCD with PIC Microcontroller. . In the previous post of this tutorial, we have seen the basics of Proteus and..... Listed under: [LCD Projects](#)
- 
1357.  [DC Motor Drive Circuit in Proteus ISIS](#) Hello friends, hope you all are fine and enjoying good health. In the previous posts, we have seen How to design a 5V DC power supply in Proteus ISIS and after that we have also discussed How to design a variable DC Power supply using..... Listed under: [Motor Projects](#)
- 
1358.  [RC5 IR Remote Control Decoder with PIC12F1822 Microcontroller](#) This topic shows an easy and effective way for decoding IR (Infra-Red) remote controls that use Philips RC-5 communication protocol, but first we've to understand how the RC5 protocol works. This Wikipedia link has good info about the RC5 protocol. The RC-5 protocol was developed..... Listed under: [LCD Projects](#)
- 
1359.  [Stepper Motor Drive Circuit in Proteus ISIS](#) Hello friends, hope you all are healthy, wealthy and wise. Today's topic is about the control of stepper motor. In the last post we have seen How to control DC motor in Proteus, and now we are gonna see How to design a Stepper Motor..... Listed under: [Motor Projects](#)
- 
1360. [Unipolar Stepper Motor Control Example with PIC12F1822 Microcontroller](#) This topic shows how to drive 5V unipolar stepper motor in 3 modes one-phase, two-phase and half step. The microcontroller used in this project is Microchip PIC12F1822 and the motor drive circuit is ULN2003.



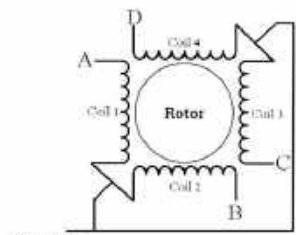

Unipolar Stepper Motor

Usually the unipolar stepper motor has 5 wires one for motor..... Listed under: [Motor Projects](#)

1361.

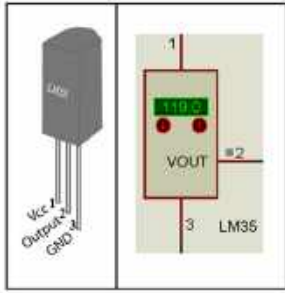

[Digital Thermometer using PIC16F877A and LM35](#) This is a simple project showing you how to read LM35 analog temperature sensor using a PIC microcontroller and six seven segment (common cathod).In this tutorial we will make a practical use of multiplexed seven segment displays. We will use them to show current temperature..... Listed under: [Temperature Measurement Projects](#)

1362.

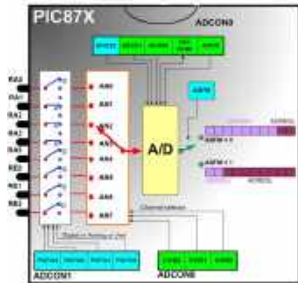

[Digital Voltmeter using PIC16F877A](#) This is a simple project showing you how to make a digital voltmeter of range 0-20V using microcontroller PIC16F877A and a Liquid Crystal Display 16x4 HD44780 LCD in Proteus ISIS. The microcontroller PIC 16F877A has 8 analog input channels for the in-built 10-bit ADC. In..... Listed under: [Metering - Instrument Projects](#)

1363.



[Double sensor interface Indoor/OutdoorThermometer using PIC16F877A Microcontroller](#) This is a simple project showing you how to read LM35 analog temperature sensor using a PIC microcontroller and LCD 4x20 in Proteus ISIS. In this tutorial we will make a practical use of the ADC. We will use them to show current temperature using..... Listed under: [Temperature Measurement Projects](#)

1364.

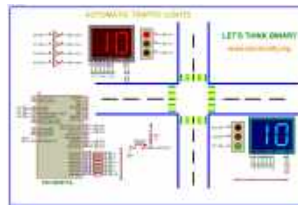

[Automatic traffic light using PIC16F877A Microcontroller](#) The objective of this project is to design a traffic light control system. This traffic light controller is used at the intersection that consists of a main road and two side roads. A four way traffic light control system with count down timers is to..... Listed under: [LED Projects](#)

1365.



[AUTOMATIC WATER LEVEL CONTROLLER USING MICRO-CONTROLLER PIC18F45K22](#) The objective of this project is to design an automatic water level control system. It indicates the level of water in the tank and automatically controls it by using PIC Microcontroller and water level sensors. Water Sensor [caption id="attachment\_15251" align="aligncenter" width="500"] Water Sensor[caption] Water level..... Listed under: [Robotics - Automation Projects](#)

1366.

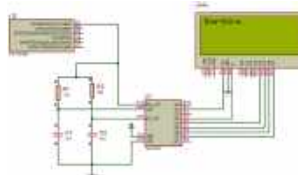

[How to make own serial LCD display for PIC12F683 Microcontroller](#) Alphanumeric LCD generally HD44780 model is very popular display . This LCD use 8 pins for data display and three pin for control and AL together 16 pin . There will be problem on project if we have to connect numbers of components in single..... Listed under: [LCD Projects](#)

1367.



[Home Security Alarm System using PIC18F45K22 AND PIR Motion Sensor2](#) This project describes a home security alarm based on a Passive Infra-Red sensor module (HC-SR501) and PIC18F45K22 . PIR sensor is used to detect motion in the environment and is commonly known as motion sensor. When the microcontroller detects the PIR sensor is triggered, it..... Listed under: [Security - Safety Projects](#)

1368.

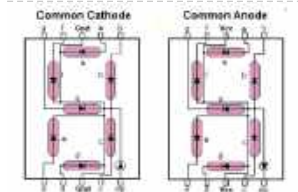

[Multiplexing 7 Segment Display using PIC18F2550 Microcontroller](#) This tutorial describes how to implement decimal counter which will increment from 0000 to 9999 ; in multiplexed seven segment display using PIC18F2550 in PROTEUS ISIS. Multiplexing is required when we want to interface 3 or 4 or even more such displays with MCU ssince..... Listed under: [LCD Projects](#)

1369.

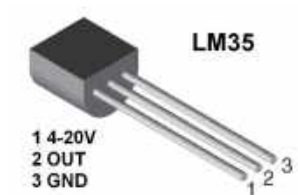

[Display temperature on Graphic Liquid Crystal Display using PIC16F877A Microcontroller](#) Hello everybody welcome back . Today I'm gonna tell how you can display temperature with bar graph on Graphic LCD using PIC microcontroller . The project is very simple to understand if you have concept of Graphic LCD .The program in this project is written..... Listed under: [Temperature Measurement Projects](#)

1370.

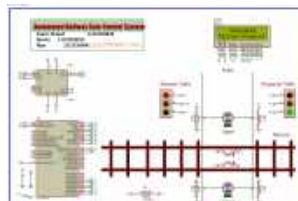

[Automatic Railway Gate Control System Using PIC16F877A microcontroller](#) Generally railway gates are closed or opened manually by gatekeeper to prevent collision between road traffic and train . Time schedule and other information are sent from the main controller station manually in this tutorial we will try to make a railway line which has..... Listed under: [Other Projects](#)

1371.

[SKIN TEMPERATURE MEASUREMENT](#) Abstract: This report represents the design and implementation of a skin temperature measurement system. The system aims to measure the skin temperature from a sensor and send it to the PC using a USB cable to display on screen. The data needs to be updated..... Listed under: [Temperature Measurement Projects](#)

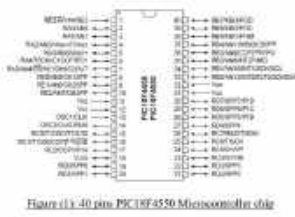

Figure 13. 40 pins PIC18F4550 Microcontroller



1372. [Interfacing 7-segment display with PIC12F1822 using CCS PIC C compiler](#) The easiest way to interface 7-segment display with PIC12F1822 microcontroller is to add a serial-in parallel-out shift register. The adding of the shift register minimizes the number of pins used by the 7-segment display. This topic shows how to make a 3-digit digital counter with multiplexing and..... Listed under: [LED Projects](#)



1373. [Unipolar Stepper Motor Control From IR Remote Control Using PIC18F4550](#) This project shows how to control a 5V unipolar stepper motor from IR remote control uses NEC protocol with PIC18F4550 microcontroller. This controller controls the stepper motor speed and direction of rotation. If you want to see how to drive the unipolar stepper motor using..... Listed under: [Motor Projects](#)



1374. [CD-ROM BLDC motor controller using PIC18F4550 and L293D](#) In the following topic URL we've seen how to control BLDC motor speed and direction of rotation using PIC18F4550 microcontroller and 3-phase bridge circuit:CD-ROM Spindle motor (BLDC) control with PIC18F4550 microcontroller This topic shows how to make the same controller using L293D motor driver instead..... Listed under: [Motor Projects](#)

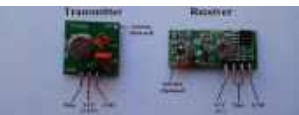

1375. [433MHz RF remote control system based on PIC microcontroller](#) 5-Channel RF (Radio Frequency) remote control transmitter/receiver using PIC18F4550 microcontroller Today RF modules are widely used in many applications (wireless data transmission, quadcopter, car remote control....). This project shows how to use low cost 433MHz RF transmitter/receiver modules to build a 5-channel wireless RF remote..... Listed under: [Development Board - Kits](#)

[Projects](#)

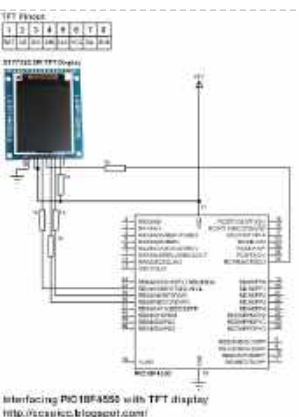

Interfacing PIC18F4550 with TFT display  
http://cccpic.blogspot.com/

1376. [Interfacing PIC18F4550 with 1.8" TFT display](#) This post shows how to connect ST7735S TFT display to PIC18F4550 microcontroller and display different things (numbers, text, lines, circles .....). The compiler used is CCS PIC C. To interface PIC18F4550 with the ST7735 TFT display we need a small library (driver) which can be..... Listed under: [LCD Projects](#)



1377. [Display BMP images from SD card on ST7735 TFT screen](#) This example shows how to display Bitmap (BMP) image files from SD card on ST7735 1.8" (128x160) TFT screen using PIC18F4550 microcontroller and CCS PIC C compiler. To build this project we need the ST7735 TFT driver, SD card driver and FAT16 library. The three..... Listed under: [Memory - Storage Projects](#)

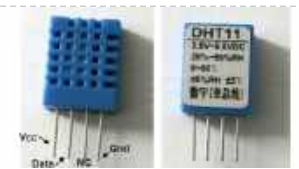

1378. [Interfacing PIC16F877A with DHT11 \(RHT01\) sensor Proteus simulation](#) PIC16F877A + DHT11 (RHT01) Proteus simulation This topic shows how to interface DHT11 (RHT01) digital relative humidity and temperature sensor with PIC16F877A microcontroller, and how to simulate this interfacing using Proteus. Note that for the simulation Proteus version should be 8.1 or higher. With these versions..... Listed under: [Sensor - Transducer - Detector Projects](#)



1379. [Interfacing PIC16F877A with DHT22\(AM2302-RHT03\) sensor using CCS PIC C](#) Interfacing PIC16F877A with DHT22(AM2302-RHT03) digital humidity and temperature sensor This topic shows how to interface PIC16F877A microcontroller with DHT22 sensor with hardware circuit. Related topic: The following topic shows PIC16F877A microcontroller and DHT22 Proteus simulation and some details about this sensor. PIC16F877A and DHT22(AM2302, RHT03)..... Listed under: [Sensor - Transducer - Detector Projects](#)

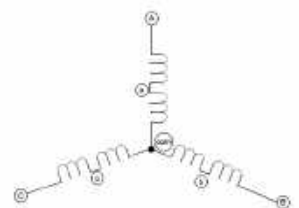

1380. [Sensored brushless DC \(BLDC\) motor control with PIC16F877A microcontroller](#) Sensored BLDC motor control using PIC16F877A - CCS PIC C compiler This topic shows an easy way to drive a Cd-Rom sensored brushless DC motor (BLDC motor) using PIC16F877A microcontroller with CCS PIC C code. This motor is three phase motor, it has three stator..... Listed under: [Sensor - Transducer - Detector Projects](#)





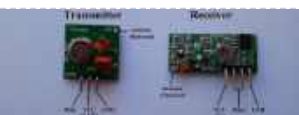





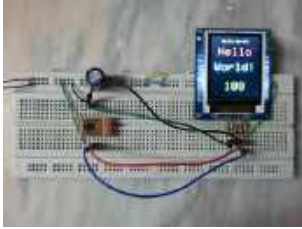

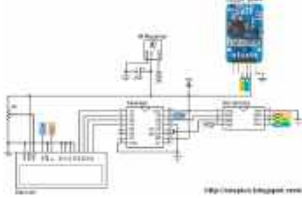

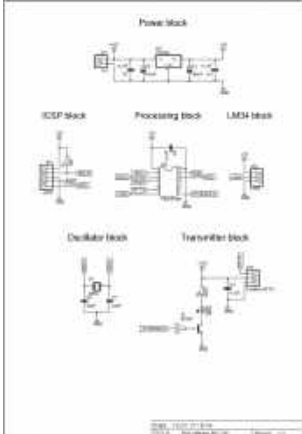
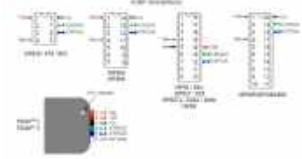
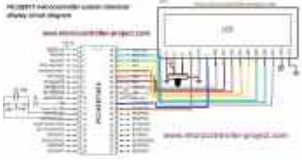



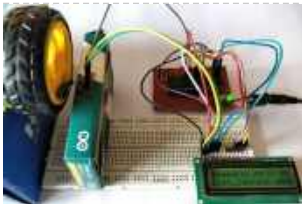



1381. [4-Digit 7-Segment display with 74HC595 shift register](#) There are many topics in this blog talking about the 7-segment display and how to interface it with different types of PIC microcontrollers. One of these topics shows how to interface PIC16F877A with a multiplexed 4-digit 7-segment display with the shift register 74HC164N. There are..... Listed under: [LED Projects](#)



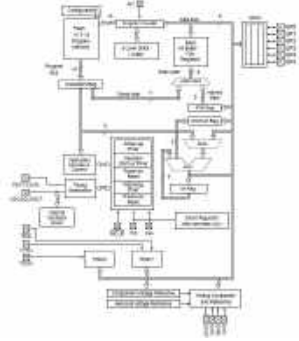

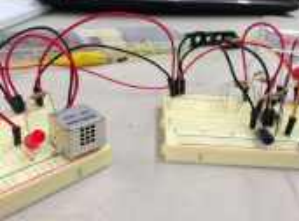





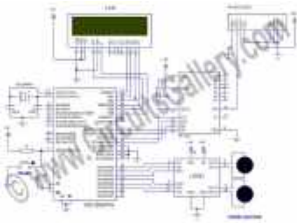

1382. [433MHz Radio Frequency \(RF\) transmitter and receiver using PIC12F1822](#) 433MHz RF Remote control system with PIC microcontroller This project shows how to use low cost 433MHz RF transmitter/receiver modules to build a 5-channel wireless RF remote control system using 2 x PIC12F1822 microcontrollers. The used RF modules in this project are cheap and easy..... Listed under: [Radio Projects](#)



1383.  [Interfacing PIC12F1822 with ST7735 SPI TFT display](#) This post shows how to interface PIC12F1822 microcontroller with ST7735 SPI TFT display using CCS PIC C compiler. For this interfacing we need a driver for the TFT display. Driver topic at the following link: ST7735 SPI TFT Display Driver for CCS PIC C compiler..... Listed under: [LCD Projects](#)
1384.  [Interfacing SD card with PIC12F1822 \(Raw data read\)](#) With the tiny microcontroller PIC12F1822 we can read raw data (sectors) stored in the SD card. The SD card can work in SPI mode which makes our interfacing more better since the PIC12F1822 MCU has a built-in SPI module (MSSP module). This post shows how..... Listed under: [Other Projects](#)
1385.  [PIC12F1822 + DS3231 + Remote Control](#) PIC12F1822 is a small microcontroller has only 8 pins which is not enough for building a real time clock using DS3231 with set buttons because the DS3231 needs 2 pins and the LCD screen needs 3 pins, therefore I've only 1 free pin. I connected..... Listed under: [Blog](#), [Wireless Projects](#)
1386.  [Interfacing PIC16F84 with DS3231 RTC](#) This post shows how to make a real time clock and calendar using PIC16F84 and DS3231 RTC. The DS3231 uses I2C protocol to interface with the master device which is in this example the PIC16F84A MCU. In this project software I2C is used because the..... Listed under: [LCD Projects](#)
1387.  [Make a Wireless Thermometer with a PIC Microcontroller](#) Introduction In this article, I'll show you one way to make a wireless thermometer using two PIC microcontrollers. One microcontroller, the PIC16F688, will measure voltage from an LM34, convert it to an ADC value, and transmit some data. The receiver will receive the data, and display..... Listed under: [Wireless Projects](#)
1388.  [PicKit2 Clone Designed and Manufactured at Home](#) PicKit2 is a programmer designed by Microchip to program its pic microcontrollers. PicKit2 supports many 8-bit pic microcontroller series. PicKit2 supports almost all Pic-10/12/16/18/24 and dspic-30/33 flash series microcontroller's. PicKit 2 is an ICSP (In-circuit serial programmer) programmer. In icsp interface, microcontroller can be programmed while..... Listed under: [Other Projects](#)
1389.  [Display custom characters on 16x2 lcd using Microchip Pic16f877 Microcontroller](#) Here is a simple project on how to build/generate/make custom characters in 16x2 lcd and then print/display them on lcd using microchip pic16f877 microcontroller. Character lcd contains a set of ascii characters and some Chinese characters in their controllers. We invoke the ascii characters present..... Listed under: [LCD Projects](#)
1390.  [Interfacing ESP8266 with PIC16F877A Microcontroller](#) Interfacing PIC16F877A Microcontroller with ESP8266 In this article, let us discuss how to interface WIFI module ESP8266 with a PIC microcontroller. So far you might have been using the ESP8266 module as a standalone microcontroller or might have been using it with the Arduino library. But..... Listed under: [Wifi - WLAN Projects](#)
1391.  [IR Remote Controlled Home Automation using PIC Microcontroller](#) R Remote Controlled Home Automation using PIC Microcontroller In this project, we are going to use a PIC microcontroller to remotely control few AC loads by just using an IR remote. A similar project IR remote controlled Home automation has already been done with Arduino..... Listed under: [Wireless Projects](#)
1392.  [How to Send E-mail using PIC Microcontroller and ESP8266](#) In this tutorial let us learn how to send E-mails from PIC Microcontroller using famous WiFi module the ESP8266. This tutorial uses PIC16F877A IC and MPLABX and XC8 compiler for programming. At the end of this tutorial you will be able to send E-mail from any..... Listed under: [Wifi - WLAN Projects](#)
1393.  [High/Low Voltage Detection and Protection Circuit using PIC Microcontroller](#) High and Low Voltage Power Detector Circuit with Message Alert using PIC Microcontroller We often see voltage fluctuations in electricity supply at our home, which may cause malfunction in our home AC appliances. Today we are building a low cost High and Low Voltage Protection..... Listed under: [power - energy projects](#)
1394.  [Digital Speedometer and Odometer Circuit using PIC Microcontroller](#) Digital Speedometer and Odometer Circuit using PIC Microcontroller Measuring the speed/rpm of a Vehicle or a motor has always been a fascinating project for us to try. So, in this project we are going to build one using the Industrial ready PIC microcontrollers. We will..... Listed under: [LCD Projects](#)
1395.  [How to Save Data using EEPROM in PIC16F877A Microcontroller](#) Saving Data using EEPROM in PIC16F877A In this tutorial we will learn how easy it is to save data using the EEPROM present in the PIC16F877A Microcontroller. In most real time projects we might have to save some data which should not be erased even..... Listed under: [LCD Projects](#)

1396.  [How to Use Interrupts in PIC16F877A Microcontroller](#) How to Use Interrupts in PIC16F877A Microcontroller In this tutorial we will learn how to use an External Interrupt in PIC Microcontroller and why/where we will need them. This is a part of the sequence of PIC Tutorials in which we started learning PIC Microcontrollers..... Listed under: [LCD Projects](#)
1397.  [GSM module Interfacing with PIC Microcontroller – Make and Receive Calls](#) GSM Interfacing with PIC Microcontroller PIC16F877A - Make and Receive Calls GSM modules are fascinating to use especially when our project requires remote access. These modules could make all actions that our normal mobile phone could do, like making/receiving a call, sending/receiving a SMS, connecting..... Listed under: [Phone Projects](#)
1398.  [Obstacle Avoiding Robot using PIC Microcontroller](#) Obstacle Avoiding Robot using PIC Microcontroller Obstacle Avoider Robot is another famous robot which spices up embedded projects. For those who are new Obstacle avoider robot, it is just a normal wheeled robot which could navigate its way without hitting on any obstacles. There are..... Listed under: [Robotics - Automation Projects](#)
1399.  [Line Follower Robot using PIC Microcontroller](#) A Line Follower Robot is a simple yet fascinating robot for most students/hobbyists to build. In this tutorial we will learn How a Line Follower Robot Works and how we can build one using the PIC Microcontroller PIC16F877A. PIC16F877A is a 40-pin Multipurpose MCU from..... Listed under: [Robotics - Automation Projects](#)
1400.  [PROJECT FINAL WRITE-UP](#) Our efforts in this project were to create a version of a Microchip mid-range PIC microcontroller in verilog to run on an Altera DE2 board. It was primarily planned to create a machine that would follow a set of pre-determined instructions and perform computation, interpretation,..... Listed under: [LCD Projects](#)
1401.  [A PIC16F84A Alarm Clock](#) Here is a simple PIC16F84A alarm clock. This page summarizes this discussion (in french) in my forum, where Samir (aka numerique1) requested for help to build a weekly alarm clock for his school. Many thanks to him for his tests and patience. This clock counts..... Listed under: [Projects](#)
1402.  [Programmer using PIC16F84 microcontroller](#) Build a low-cost and very simple serial programmer for a PIC16F84 Microchip Flash Microcontroller. Below picture is my personal writer for F84 chip, it works very nice with Nigel WPicProg V1.20. Introduction I finally found a very nice universal window based software designed to work..... Listed under: [Microcontroller Programmer Projects, Projects](#)
1403.  [Garage car detector without a microcontroller](#) At the end of this instructable you will be able to detect your car as it approaches the wall inside your garage, signalling you that the car is inside far enough so you can close the door. Most car sensors will use a microprocessor to..... Listed under: [Car Projects](#)
1404.  [Adapter for small size PIC/AVR chip programming](#) This is a homemade adapter I made for programming SOIC/QFN size microchips that I use in my micro airplanes (<http://maxoffsky.com/tech-blog/rc-micro-spitfire-airplane-build-log/>). I had trouble connecting the chips any other way so I made my own universal adapter. This could also be used to do In-Circuit programming..... Listed under: [Microcontroller Programmer Projects](#)
1405.  [IR Tracking Turret with PIC and C](#) This is a good learning project that is fun to build - I got a lot out of making it. I think this has been done quite a bit already, but I did not find a straightforward way of doing this with PICs. When I..... Listed under: [Other Projects](#)
1406.  [Red Light for Astronomy Observing using PIC12F683](#) When doing astronomy observing at night preserving night vision is critical. This requires using the minimum amount of light that makes the sky charts readable. What is this minimum level depends on how dark are your surroundings, how much time you have spent in darkness,..... Listed under: [Home Automation Projects, LED Projects, Projects](#)



1407.  [How to make a computer controlled Robot Project Using PIC16F877A? using pic microcontroller](#) After a short break, we're back to the DIY robot projects series and I am sure you'll love this one too. Before that I suggest you to go through all our earlier simple robotics projects for engineering students as well. This time, major difference is..... Listed under: [Robotics - Automation Projects](#)
- 
1408.  [Scalextric Sport Race Start Controller using PIC16F627A](#) Overview I developed this after my nephews got a Scalextric Sport slot car racing set for Christmas. The set included a lap timer and counter but one thing that was missing was a way to start a race. Having someone say "3-2-1-Go" wasn't really doing..... Listed under: [Car Projects](#), [Game - Entertainment Projects](#), [Projects](#)
- 
1409.  [Development system for PIC and AVR microcontrollers](#) After testing many systems development for PIC and AVR microcontrollers, none satisfy me. So I created this system with breadboard that has satisfied me. Step 1: More space free In this development system, I put two protoboards turned 180 degrees from each other. The space..... Listed under: [Development Board - Kits Projects](#), [Microcontroller Programmer Projects](#)
- 
1410.  [Search Results for: Temperature Controlled Fan using 8051 Microcontroller ...](#) Temperature Controlled Fan Report - SlideShare - Temperature controlled fan regulator - electronic circuits, 33 thoughts on " temperature controlled fan regulator " siddhu march 12, 2015 at 7:00 am. i didn't find 100k ptc,5k ptc where are they available and does the Android controlled..... Listed under: [Temperature Measurement Projects](#)
- 
1411.  [Breakout board for 18-pin PIC16F series microcontrollers](#) The 18-pin microcontrollers from PIC16F series have always been my favorite processors. They are small in size (so occupies less area on the circuit board), and are very easy to use. Besides they are capable enough to do most projects that don't require a large..... Listed under: [Development Board - Kits Projects](#)
- 
1412.  [Skateboard with PIC microcontroller and LEDs](#) What do you get when an Electrical Engineer builds a Skateboard from scratch for a 13 year old's Christmas present? You get a skateboard with eight white LEDs (headlights), eight red LEDs (taillights) all controlled via PIC microcontroller! And I might add, one very happy..... Listed under: [LED Projects](#)
- 
1413.  [IR Digital Thermostat for FAN](#) Introduction This circuit measures temperature in Celsius scale and displays it on an alphanumeric LCD screen When temperature rise to 40 C an alarm is activated and at the same time a relay is also activated which drives a fan to keep the temperature at..... Listed under: [Temperature Measurement Projects](#)
- 
1414.  [Tutorial: Building cool projects with MCUs \(Part 3\)](#) Tutorial: Building cool projects with MCUs (Part 3) As we proceed onto the third portion of this microcontroller tutorial, let's first revisit what we have accomplished thus far. In Part 1, we defined what a microcontroller actually was. I wanted to get everybody on-board (no pun intended)..... Listed under: [Interfacing\(USB - RS232 - I2c -ISP\) Projects](#)
- 
1415.  [COFFEE POWER MANAGER using PIC16F628](#) Introduction The problem was this...at Redeeming Grace Church we were meeting in a public school prior to moving in to our permanent facility. Each Sunday morning we would bring in three large percolating coffee pots to brew regular, decaf, and hot water for the mid-service..... Listed under: [Home Automation Projects](#), [Projects](#)
- 
1416.  [Smart doorbell System](#) Introduction On request I have built a microcontroller-based doorbell system which is being used in an industrial environment. This is the basic function: When you push the bell-button, a horn will sound for about 10 seconds. At the same time a light, which keeps burning..... Listed under: [Home Automation Projects](#)
- 
1417.  [Sonar range finder using PIC16F88 Microcontroller](#) The PIC sonar range finder works by transmitting a short pulse of sound at a frequency inaudible to the ear (ultrasonic sound or ultrasound). Afterwards the microcontroller listens for an echo. The time from transmission to echo reception lets you calculate the distance from the..... Listed under: [Projects](#), [Sensor - Transducer - Detector Projects](#)
- 
1418. [Ponyprog Circuit for AVR & PIC16F84](#) Comments: All resistors are 1/4W.The circuit is powered by 9...15V DC or AC. When In Circuit Programming (ISP) connectors are used, is possible the programmer to be powered from target's power source. Diodes D2 and D6 protect the regulator LM7805, when target's power is used..... Listed under: [Development Board - Kits Projects](#)
-

Row	Quantity	Reference	Part
1	1	C1	100uF25V or 450uF
2	1	C2	10k 1/4W
3	8	C3	100nF
4	1	CP	5V1.8V
5	2	CR	100k
6	1	DR	100k
7	4	DR	100k
8	1	DR	100k
9	1	DR	100k
10	1	DR	100k
11	1	DR	100k
12	1	DR	100k
13	1	DR	100k
14	1	DR	100k
15	1	DR	100k
16	1	DR	100k
17	1	DR	100k
18	4	DR	100k
19	1	DR	100k
20	2	DR	100k
21	1	DR	100k
22	1	DR	100k
23	1	DR	100k
24	4	DR	100k
25	2	DR	100k
26	1	DR	100k
27	1	DR	100k
28	1	DR	100k
29	1	DR	100k
30	1	DR	100k
31	1	DR	100k
32	1	DR	100k
33	1	DR	100k
34	1	DR	100k

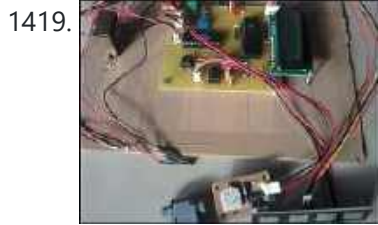

**1419. [Microcontroller based Data Logger](#)** Description: This project is a fine combination of analog and digital electronics. This project is designed so as to fulfill the requirements of the industry applications, home applications. The project consists of parameters monitoring, parameter storage. PC interface is one of the main features of..... Listed under: [LCD Projects](#)



**1420. [Microcontroller Tutorial 4/5: Creating a Microcontroller Circuit Board](#)** We are now in the fourth part of the microcontroller tutorial. We have a microcontroller circuit diagram ready. It's time to make a circuit board. I love this part. This is the "magical" step that takes the idea we started with and turns it into..... Listed under: [Development Board - Kits Projects](#)

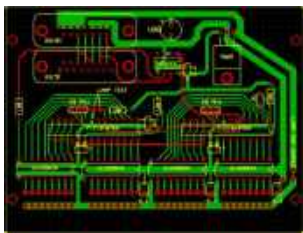

**1421. [microcontroller based projects circuit free](#)** Analogue electronics, digital circuits and microcontrollers simulation, all in one. Another free Espresso-based minimisation tool. PLD and FPGA project flow Electronics circuit diagrams and projects based on microcontroller. 8051-BASED EEPROM MICROCONTROLLERS. HUM-FREE BATTERY ELIMINATOR Please I need a circuit diagram of a speed checker on..... Listed under: [Development Board - Kits Projects](#)



**1422. [PIC Microcontroller project – 24 hour clock and thermometer displayed via 16f690 microcontroller and LCD programmed in C](#)** I got to thinking that an interest in hi-fi can be a bit geek ( in a good way ) so I thought one of my latest geek projects might be of interest to some of you. You could build the project 'as is' without..... Listed under: [LCD Projects](#)



**1423. [A Self-Contained Data Logging Anemometer](#)** I love collecting and analyzing data. I also love building electronic gadgets. A year ago when I discovered the Arduino products, I immediately thought, "I'd like to collect environmental data." It was a windy day in Portland, OR, so I decided to capture wind data..... Listed under: [Motor Projects](#)



**1424. [SUN TRACKER'S WINGS](#)** The giant (by radio control standards) servos above are shown adjacent to a Nokia 3310 mobile phone to give an idea of the scale. The arms are 12cm long - perfect for lifting a bank of solar panels (wing). Our local Model Aerodrome in Seaside..... Listed under: [Phone Projects](#)



**1425. [Pimp My Rocket \(Espresso Machine\)](#)** Combining Coffee and Electronics – An Idea for a Project Having played around with fixed function logic ICs, such as the Johnson counter used in the Spindicator project, I was keen to move on and experiment with programmable microcontrollers. I decided to obtain and play with some..... Listed under: [LED Projects](#)



**1426. [Hard Drive Clock using PIC16F628](#)** ave an old hard drive that no longer works? As long as it still spins up chances are you could build a clock out of your old hard drive! You will need some electronic knowledge, some common electronic components and a bit of patience. The..... Listed under: [Clock and Timer Projects](#)

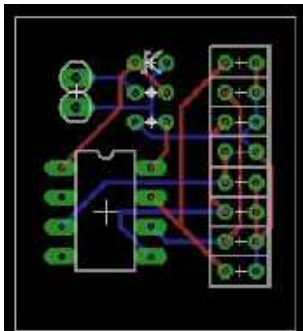

**1427. [Knight Rider Light computer – version 2](#)** This knight rider light computer is a successor of my first version of the Knight Rider. This version is much smaller and justifies the use of a microcontroller. The project is based on the PIC 12F629 microcontroller. The hardware part Unlike my previous project this..... Listed under: [LED Projects](#)

**1428. [RGB REMOTE \(pinguino+web+linksys\) using PIC18F2550 microcontroller](#)** RGB REMOTE (pinguino+web+linksys) This project has several uses, it is basically a way to control an RGB LED group (tricolor with common ground) via a web page to select which color we want to show. It may be





a way to harmonize a room, change..... Listed under: [LED Projects](#), [Projects](#)

1429.



[Cheap PIC Programmer](#) This programmer works only with PIC16F84 but it's great because it never causes errors and works with almost all computers, unlike some other homemade programmers. Step 1: Step one : Materials For this programmer you won't need many materials. In fact , you will find all you..... Listed under: [LED Projects](#)

1430.



[Microcontroller controlled Home Entertainment System](#) This Instructable will take you on my journey to replace my old Netflix/Vudu Bluray player with a PC based entertainment station for my LCD projector. I wanted to be able to access and control Netflix, Hulu, Youtube, Crackle, NBC, ABC, and the Weather Channel using..... Listed under: [Home Automation Projects](#)

1431.



[Easy Way to Design an Automatic Driverless Train](#) Every one in the metro cities like Kolkata, Delhi enjoying the luxuries of the metro train ever spared a thought about the train? No, then let me give you a brief idea about the driverless automatic driven and controlled train. But before that let us..... Listed under: [LED Projects](#)

1432.

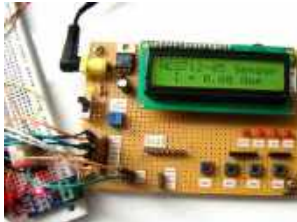

[A brief overview of Allegro ACS712 current sensor. Part 2 – Interface the sensor with a PIC microcontroller](#) In the first part of this discussion, the features of ACS712 device were briefly discussed. Now we will use that theory to implement the ACS712 sensor to make a simple DC current meter. The analog output voltage from the sensor is measured through an ADC..... Listed under: [Interfacing\(USB - RS232 - I2c -ISP\) Projects](#), [Sensor - Transducer - Detector Projects](#)

1433.



[PIC12F675 external interrupt code and Proteus simulation](#) This post provides the external interrupt code for PIC12F675 microcontroller (e-g when you need to control servo motor which has position encoder, with your PIC microcontroller). As we know, PIC12F675 microcontroller has one GP2/INT pin, which can be used to service external interrupts. This code is written..... Listed under: [Interfacing\(USB - RS232 - I2c -ISP\) Projects](#), [Projects](#)

1434.



[Video Clock Superimposer using PIC16C711](#) About the Project As a followup to my VCR Pong project, here is a gadget that is actually useful in the Real World! It superimposes the time of day, in "HH MM SS" format, in the bottom right-hand corner of an existing video signal. My..... Listed under: [Clock and Timer Projects](#)

1435.

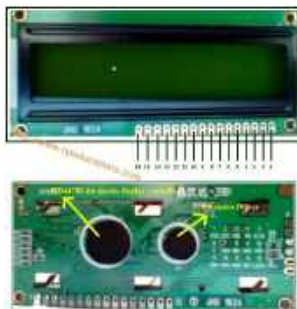

[Interfacing 16x2 LCD with PIC Microcontroller](#) In this session we will see how to interface 16x2 LCD to PIC18F4550 microcontroller which is of family PIC18F. You can get information of 16x2 LCD in the session How to Interface 16x2 LCD with 8051 Microcontroller Features of PIC18F4550: PIC18F4550 belongs to the PIC18F family;..... Listed under: [Interfacing\(USB - RS232 - I2c -ISP\) Projects](#)

1436.







[Project Board using PIC18F2550 microcontroller](#) The new PIC18F2550 Project Board was designed as the development platform for student projects. The board features MCU: PIC18F2550 with external xtal, ADC: one channel 0-2.5V sigma-delta converter, Linear Technology LTC2400/LTC2420, 6-channel 10-bit ADC 0-5V, Display: Two connectors for text LCD or GLCD, USB: onchip..... Listed under: [Development Board - Kits Projects](#), [Projects](#)

1437.











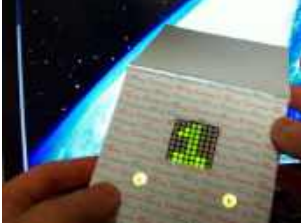

[PIC microcontroller Beginner's guide: Basic connection circuit](#) What is a pic microcontroller? The PIC microcontroller is a low cost 'computers on a chip' manufactured by Microchip. They allow electronic designers and hobbyists impart intelligence and logic to a single chip for special purpose applications and products. The PIC microcontroller programming is done using..... Listed under: [Development Board - Kits Projects](#)

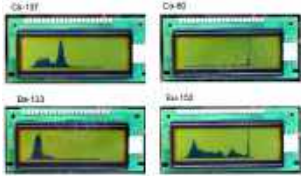







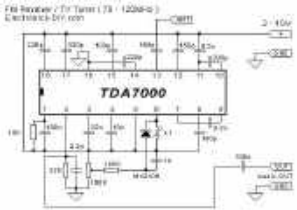

1438.  [Cooper Bills \(csb88\) and Anish Borkar \(ab673\)](#) Introduction The Handy Lab Buddy is a tool every ECE should have. The four features of this tool include a talking voltmeter, logic probe, voltage averager, and frequency measurer. As a cheap and accurate device that outputs whatever being measured through speakers, it's one of..... Listed under: [LED Projects](#)
1439.  [Voltage programmable simple logic device using PIC12F675](#) Description Here's another daft yet interesting PIC12F675 idea I came up with. When I wanted to show someone how logic gates worked I could only find a NAND gate which wasn't very handy for demonstrating AND's OR's, NOR's and ExOR's. I also wanted to have..... Listed under: [Interfacing\(USB - RS232 - I2c -ISP\) Projects, Projects](#)
1440.  [VCR Pong using PIC16C711 Microcontroller](#) About the Project Here is a fascinating and nostalgic project that kept me up many, many nights last summer (creating it, not playing the game!). I had long thought it would be exciting to try to generate video from a PIC, and with built-in A/D..... Listed under: [Projects, Video - Camera - Imaging Projects](#)
1441.  [Electronic Code locking system using PIC 16F877 Microcontroller](#) Electronic code locking system is extremely useful in protecting our precious possessions and can be installed anywhere with bit of engineering in it. We are widely familiar with the Password based e-locks and might have installed in our house. But we are going for Electronic..... Listed under: [Microcontroller Programmer Projects](#)
1442.  [Quozl's Temperature Sensor Project using PIC12C509](#) Introduction Just a handful of components builds an 8-pin microcontroller based circuit for temperature logging via a serial port; small, fast, and acceptably accurate. Features provides real-time data to your computer via serial port, interfaces up to four DS1820 temperature sensors, absolute accuracy near 0.5..... Listed under: [Projects, Sensor - Transducer - Detector Projects, Temperature Measurement Projects](#)
1443.  [IO Controller with serial port CLI using PIC16F627A](#) This code runs on a PIC 16F627A or 628A (and A.F.A.I.K 627/628 parts). It uses the serial USART on the PIC to communicate with a PC. Through this a simple CLI (Command Line Interface) is implemented that allows commands to be sent to the PIC..... Listed under: [Other Projects, Projects](#)
1444.  [Basic PIC circuit is not working](#) I have just begun in the world of micro-controllers, and the first micro-controller. I chose to work with was the PIC from Microchip. The PIC I am using is the PIC16F877A. I am using MPLAP IDE and HI-TECH C. I am trying to make an..... Listed under: [Development Board - Kits Projects](#)
1445.  [Lecture 45 : PIC Serial Communication using Serial Peripheral Interface \(SPI\)](#) Objective To establish serial communication between two PIC16F877A microcontrollers Description In this experiment, 8-bit digital input is applied at Port-B to one of the PIC16F877A microcontroller which acts as a master in serial communication. The input value is transmitted by the master serially via Serial..... Listed under: [Interfacing\(USB - RS232 - I2c -ISP\) Projects](#)
1446.  [Treslie – A 3-phase speaker system for Leslie emulation using PIC18F26K20](#) This post describes the design and construction of a 3-phase loudspeaker intended for Leslie Speaker emulation. The unit is intended to be driven by a 3-channel audio amplifier The Brute, which in turn is controlled by LEMS, a micro-controller based control system, the construction of..... Listed under: [Projects, Sound - Audio Projects](#)
1447.  [How to Program a PIC Microcontroller to Build a Project](#) The recent trends in the advanced technology are helpful in developing most advanced electronic gadgets. Most of these electronic devices are developed using microcontrollers. The microcontroller is an electronic component, which is programmed to perform various control operations. There are various kinds of microcontrollers available,..... Listed under: [Interfacing\(USB - RS232 - I2c -ISP\) Projects](#)
1448.  [Interfacing with UART of PIC microcontroller](#) This post provides the solution for using the PIC controller UART interface (e-g to connect PIC controller with PC using serial adapter). Complete code and simulation can be downloaded from the 'Downloads' section at the bottom of this post. The following figure shows the result..... Listed under: [Interfacing\(USB - RS232 - I2c -ISP\) Projects, Projects](#)

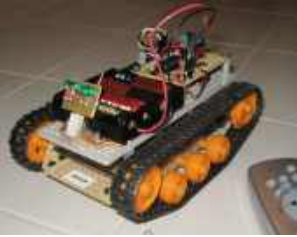

1449.  [How to display text on 16x2 LCD using PIC18F4550 Microcontroller](#) Several automated and semi-automated devices require a message to be displayed in order to indicate their working status. In continuation to LCD interfacing with PIC18F4550, this article explains how to display a message or string on a 16x2 character LCD. Programming steps:  
· Configure the..... Listed under: [LCD Projects](#)
- 
1450.  [Microcontroller Based Password Verification System](#) Aim: - To simulate a circuit using microcontroller 8051 for verifying password. Theory: - The block diagram for microcontroller based password verifying system is shown. The purpose of the circuit is to verify the password entered by the user. An 8-bit password is the input..... Listed under: [Other Projects](#)
- 
1451.  [Learning Board for PIC12F683 Microchip](#) Introduction Electronics is my hobby. When I was in college I had some experience with microcontrollers; I did few projects with Atmel's AT89C51. Recently, I have grown interest on PIC microcontrollers, and I thought I should start with 8-pin microchips. I picked PIC12F683 microchip. This..... Listed under: [Development Board - Kits Projects](#), [Microcontroller Programmer Projects](#)
- 
1452.  [PIC16F877A \(with LCD\) not working](#) I have designed a PIC16F877A micro controller project to read temperature from an LM35 using ADC, display it on an LCD and transmit it to a serial port. When the program starts, sometimes it shows a startup message - sometimes it doesn't display anything. Also,..... Listed under: [LCD Projects](#), [Temperature Measurement Projects](#)
- 
1453.  [Ultrasonic Position System](#) The ultrasonic position system uses ultrasonic transmitters/receivers to triangulate position of the robots used in GE423. Each of three transmitters uses a distinct frequencies: 23 kHz, 31 kHz, and 40 kHz. The 2812 DSP is used to measure signal timing and calculate position based on..... Listed under: [Development Board - Kits Projects](#)
- 
1454.  [PIC12F microcontroller project board](#) The 12F series of PIC microcontrollers are handy little 8-pin devices designed for small embedded applications that do not require too many I/O resources, and where small size is advantageous. These applications include a wide range of everyday products such as hair dryers, electric toothbrushes,..... Listed under: [Development Board - Kits Projects](#), [Projects](#)
- 
1455.  [Standalone BreadBoard Breakout for PIC Microcontrollers](#) I wanted to make a breadboard breakout for PIC microcontrollers after seeing this arduino breadboard breakout from adafruit. This product is fully standalone and yet has very small footprint so that it can be conveniently plugged into the breadboard. The most amazing part was that it still had..... Listed under: [Development Board - Kits Projects](#)
- 
1456.  [Microcontroller based Diode and Bipolar Junction Transistor \(BJT\) tester](#) Introduction Most of the digital multimeters these days have built-in features for testing diodes and sometimes transistors. The purpose of this project is to demonstrate a simple way to construct a testing device for diodes and bipolar junction transistors (BJTs) using a microcontroller. The testing..... Listed under: [Development Board - Kits Projects](#)
- 
1457.  [PIC12F675 Tutorial 7: A Servo controller driving a standard servo motor using serial port command](#) This servo controller generates a signals to control a standard servo motor (I used a Futaba servo but you can use any servo) using the 12F675 microcontroller. You can type a text command into a serial terminal e.g Hyperterminal to set the position of the..... Listed under: [Motor Projects](#)
- 
1458.  [MTM Scientific, Inc... PIC Project for CATV Tuner](#) The CATV Tuner sold by MTM Scientific, Inc can be used for wideband audio and video reception, as described on our other project pages such as the FM Wideband Receiver and Radio Telescope Project. A common requirement in all these projects is the need to..... Listed under: [Other Projects](#)
- 
1459.  [IC-Based H-Bridge Tutorial](#) An alternative to using a transistorized H-Bridge circuit is the L298 Dual Full-Bridge Driver. It is very easy to control and it doesn't require any calculation. Simply knowing your motor's required current and the IC's current capacity is enough. For a price though. In order to..... Listed under: [Motor Projects](#)
- 
1460.  [PIC 16F88 Digital Thermometer Light Meter and resistance ohm meter.](#) PIC 16F88 Digital Thermometer Light Meter and resistance ohm meter. My original idea for this project was simply to try and interface the WINTEK WD-C2401P lcd panel to the pic (see my previous post). I figured it would be fun to add a couple of..... Listed under: [Metering - Instrument Projects](#)

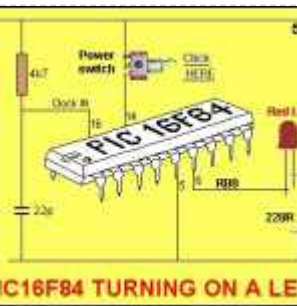
1461.  [TD-USB-02 interface with touchpad sensor board and WinAmp interface using PIC18F2550](#) TD-USB-02 interface with touchpad sensor board and WinAmp interface. This is an example USB project showing how to interface a touchpad sensor (the AD7142ACPZ) with a standard XP/Vista computer. The TD-USB-02 board with a PIC18F2550 communicates with the PC: USB 2.0 through a mini-B connector..... Listed under: [Interfacing\(USB - RS232 - I2c -ISP\) Projects, Projects, Sensor - Transducer - Detector Projects](#)
- 
1462.  [New Microchip PIC32 Microcontrollers Run at 72MHz](#) CHANDLER, Ariz., Nov. 5, 2007 - Microchip Technology today announced the new Microchip PIC32 family of MIPS 32-bit microcontrollers (MCUs). The Microchip PIC32 is based upon the MIPS32 M4K Core, a high performance core with 32 core registers that are each 32-bits. Microchip has extended..... Listed under: [Development Board - Kits Projects](#)
- 
1463.  [Christmas card with inbuilt retro video game for under \\$10](#) Hello all and welcome to my second Christmas related project. Have you ever received a really boring Christmas card? Have you ever sat there and thought to yourself "If only there were a little video game on this card that I could play..." Well ponder..... Listed under: [Game - Entertainment Projects](#)
- 
1464.  [Kaossilator 2 hack: hands free \(part 1/2\)](#) This is my first instructable.... ever. So here it goes. I own a Kaossilator 2 (KO2). It's fun little phrase synthesizer and simple looper. But it has this awkward issue with mic button. When you want to record something from microphone you have to hold..... Listed under: [Microcontroller Programmer Projects, Sensor - Transducer - Detector Projects](#)
- 
1465.  [d.i.y. Handheld Multichannel Analyzer \(MCA\) based on 16F877 PIC Microcontroller and LCD](#) Some time ago I was developing a medical instrument which required histogramming, which got me in the mood to retake my own PIC MCA project([http://home.comcast.net/~prutchi/index\\_files/scint.htm](http://home.comcast.net/~prutchi/index_files/scint.htm) ). I used the variable RAM in the microcontroller (16F877), so I limited the number of channels to 95 and let..... Listed under: [LCD Projects](#)
- 
1466.  [Chromation Systems RGB LED Tube Light](#) Built utilizing a 24 Channel High Current USB LED Controller to control 12 volt RGB LED Light Strip, in 8 separate groups. Each group has individual 8-bit PWM which can create over 16 million colors. And is driven at full current for maximum color saturation and accuracy. Using..... Listed under: [LED Projects](#)
- 
1467.  [Incredible DIY iPhone Macro](#) After taking apart dozens of disposable cameras over the years, I found myself with a lot of lenses of varying sizes and nothing to use them for... until now! By making a simple carriage that would hold the lens and attach to my iPhone via..... Listed under: [Phone Projects](#)
- 
1468.  [Interfacing DS1307 to PIC Microcontroller with C code and Circuit Diagram](#) This tutorial will help you to interface DS1307 RTC with PIC16F877 Microcontroller. The project is compiled in CCS Compiler and simulated with Proteus. The Real Time Clock is interfaced with PIC controller via I2C. I2C is a 2 wire communication protocol. I2C is used for..... Listed under: [Interfacing\(USB - RS232 - I2c -ISP\) Projects](#)
- 
1469.  [PIC16F84A MemoSound Game](#) Game rules You will have to memorize a melody, made of up to 62 steps. A step is one of the four tones available in the game system. In order to help you, each tone is associated to a color LED (yellow, green, orange, red)..... Listed under: [LED Projects](#)
- 
1470.  [Dual 4-digit seven segment LED display with SPI interface using PIC12F](#) This project is an extension of my previous MAX7219 based SPI seven segment LED display module. The new display features eight 7-segment displays arranged in two rows of four digits. The on-board MAX7219 driver enables you to easily add eight 7-segment LED displays to your..... Listed under: [Interfacing\(USB - RS232 - I2c -ISP\) Projects, LED Projects, Projects](#)



1471.  [TDA7000 FM Receiver / TV Tuner / Aircraft Receiver using pic microcontoller](#) Parts: 1x TDA7000 IC - FM Receiver 1x 3.5 Turns Variable Coil (L1) 1x MV2105 - Varicap Diode ANT - Telescopic Antenna or a piece of wire 1x 100K Potentiometer 1x 100K Resistor 1 x 22K Resistor 3x 100nF Capacitor 1x 22nF Capacitor 1x 10nF..... Listed under: [Interfacing\(USB - RS232 - I2c -ISP\) Projects](#), [Sensor - Transducer - Detector Projects](#)
1472.  [Mini PIC Dev Board using PIC18F452](#) For one reason or another I really like to use breadboards for building prototype designs. The breadboard offers superior flexibility in that you can change a single electrical connection at any time, as long as you have a long enough wire. One of the draw..... Listed under: [Development Board - Kits Projects](#), [Projects](#)
1473.  [Refregirator Temperature Controller Project \(Save Your Electricity Bill\)](#) In This Post we discuss about How to build a Refregirator Temperature Controller using Microcontroller. This Project is Development of Thermo meter project. Suggested Page>> Mlcrocontroller Based Thermo meter project Mainly we use Mikro C Programming Language in this Project and ISIS Proteus Software use..... Listed under: [Temperature Measurement Projects](#)
1474.  [IR Remote Controlled Tracked Robot](#) Step 1: Assembling the Double Gearbox A basic hobby motor turning at 12,300 RPM is basically useless without a good gearbox. Just touching the shaft will stall the motor. I obtained a Tamiya double gearbox kit for under \$10, which through a series of gears..... Listed under: [Robotics - Automation Projects](#)
1475.  [Single microcontroller based 12v to 230v inverter with intelligent battery charging](#) Single microcontroller based 12v to 230v inverter with intelligent battery charging (Made by me) Here I describe the circuit as: \*single microcontroller/controller (ATMEGA16/32) \*no op-amps, only chips are the micro, opto-couplers and regulator (7805) \*low-battery/overload/short-circuit protection \*thyristor controlled battery charger, using the MOSFET body diode..... Listed under: [power - energy projects](#)
1476.  [5 LED CUBE Controller for PIC16F688](#) Circuit Description The LED cube is made up from 125 LEDs arranged into 5 layers of 25 LEDs each. The display itself is multiplexed so instead of requiring 125 connections it requires one to each of the five layers and 25 to each LED in..... Listed under: [LED Projects](#), [Projects](#)
1477.  [Record Infrared Codes of Any Remote Control Unit for Usage with Linux Infrared Remote Control \(LIRC\) on Raspberry Pi](#) Introduction The remote controls that are orphaned when the device they control stopped working are reusable on your Raspberry Pi. After completing this instructable, you may be interested in trying out the following instructables: Reuse Unwanted Remote Control to Shutdown and Reboot Raspberry Pi Reuse..... Listed under: [Other Projects](#)
1478.  [Compact PIC18F1320 Microcontroller Board](#) When I started building Microcontroller projects I built a lot of them using the same PIC microcontroller board. These were based on the PIC18F1320 chip since I bought a lot of them. There are many other chips in the PIC family that would be equally..... Listed under: [Development Board - Kits Projects](#), [Projects](#)
1479.  [Complete Intro To PIC's - Make an LED Flash Video](#) As the title suggests, this guide is targeted for those who are new to the world of PIC microcontrollers. I cover the basics from hardware to software along with programming the device and a few hints along the way. I do assume a little bit..... Listed under: [LED Projects](#), [Projects](#)
1480.  [In-Circuit PIC Loader using PIC18F458 microcontroller](#) This loader connects the PC printer port and works with WinPic800. The loader gets DC supply from application board and provides +12V for high voltage programming mode. We can use it for programming many PIC chips easily. Hardware Schematic The In-circuit serial programming for PIC..... Listed under: [Microcontroller Programmer Projects](#), [Projects](#)
1481.  [NU32: Introduction to the PIC32 using pic-microcontroller](#) The Microchip PIC32 is a family of complex and powerful microcontrollers that can be purchased for less than \$10 in quantities of one. This microcontroller offers many peripherals useful for mechatronics purposes, such as several channels for analog-to-digital conversion, digital I/O, synchronous and asynchronous serial..... Listed under: [Video - Camera - Imaging Projects](#)
1482.  [USB Project :- USB Interface Board Using PIC18F4550](#) USB PROJECT: - USB INTERFACE BOARD USING PIC18F4550 Microcontroller CONTROL - 6 LEDS C# software ( 4.0 .net framework) PIC18F4550 Firmware - for 6 LED's. TUTORIAL FOR BEGINNERS It's a low cost USB interface Board that provides cool interface to your computer and it can..... Listed under: [Interfacing\(USB - RS232 - I2c -ISP\) Projects](#)
1483. [Generating PWM with PIC Microcontroller using CCP Module](#) PWM is a technique used to generate analog output signal using digital signals. It is commonly used to control average power delivered to a load, motor speed control, generating analog voltage levels and for generating

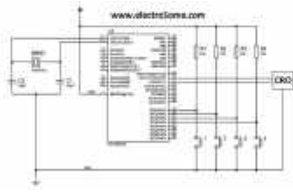

analog waveforms. CCP Modules are available with a number of..... Listed under: [PWM Projects](#)

1484.



[How to use inbuilt EEPROM of PIC18F4550 Microcontroller](#) The EEPROM (ELECTRICALLY ERASABLE PROGRAMMABLE READ ONLY MEMORY) is a very useful memory which can be used for storing data. The data storing and retrieving from any EEPROM memory is very simple compared to other kind of memories. As the name suggest the memory is..... Listed under: [Interfacing\(USB - RS232 - I2c -ISP\) Projects](#)

1485.



[Weather meter using PIC 16F877 Microcontroller](#) Weather monitoring systems are available in plenty and these are pretty handy gadgets we use in our daily life for weather forecasting and other purposes. But these kinda gadgets might be expensive and may not be available for customization to our specified purpose. To overcome..... Listed under: [Temperature Measurement Projects](#)

1486.

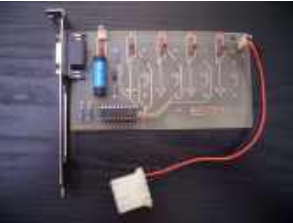

[Remote Control Server](#) One of my friends asked me if I could design a circuit for him to be able to remotely power up a server. He has 2 servers and he didn't want to keep them both on whilst he travelled. He wanted to be able to..... Listed under: [Wireless Projects](#)

1487.



[MIDI Chord Button Keyboard Using PIC18F4620 part 3](#) Connections The following table documents the connecting leads and molex pin-header numbers tying the various interfaces together. Header Pin no. Signal/Function Direction Header Pin no. Signal/Function Chord Controller-SV1 1 RD7 —> Matrix Decoder-SV4 1 Chord Sel. C Chord Controller-SV1 2 RD6 —> Matrix Decoder-SV4 2..... Listed under: [Projects, Sound - Audio Projects](#)

1488.



[POV Christmas Tree using PIC12F689 microcontroller](#) POV Christmas Tree Still don't have a tree for this holidays?, Don't worry here you have a small, reusable, eye-catching tree for your holiday needs. This project started as a SMD soldering tutorial for a course i've made in electronics, so it's meant to be..... Listed under: [LED Projects, Projects](#)

1489.

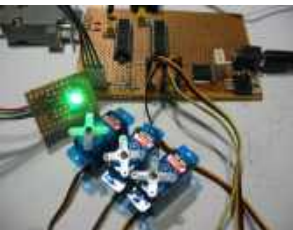

[Serial Addressable RGB PWM LED Driver using PIC16F628A](#) Overview Ever since I made the serial controlled RGB LED PWM driver I've had many requests for an addressable driver. Well I've finally got round to producing one. The code is now completed and tested and the prototype boards are fully working. The design process..... Listed under: [LED Projects, Projects, PWM Projects](#)

1490.

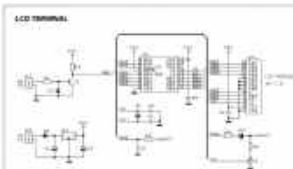

[Easy Debugging Terminal using PIC16F84](#) Introduction This LCD terminal provide two modes of operation by selecting jumper J1. When J1 is open the terminal operate as a normal ascii display terminal, when J1 is closed the terminal displays the input serial data in hexadecimal format. This mode is useful for..... Listed under: [LCD Projects, Projects](#)

1491.



[World's Smallest Low-speed USB Analyzer using pic16f877](#) [Any] idea is dead without a good application for it. So "California Dreamin'" USB virtual peripheral could be a very nice sample of academic research, but hardly anybody is going to build a keyboard or mouse using it. I have been thinking for a while..... Listed under: [Interfacing\(USB - RS232 - I2c -ISP\) Projects](#)

1492.



[Arduino powered temperature sensing RGB LED nightlight using PICaxe](#) About a year ago I started on a project to make a temperature controlled nightlight. I was inspired by seeing these lovely LED lamps styled as mushrooms growing out of pieces of wood. Those mushrooms were made out of glass, which was somewhat beyond my..... Listed under: [Home Automation Projects, LED Projects, Projects, Temperature Measurement Projects](#)

1493.





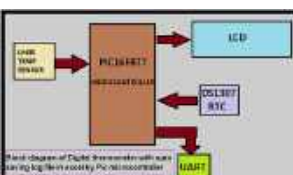

[Soundtrack using PIC16F688 Microcontroller](#) This project uses a microcontroller to drive a speaker and play one of two songs: Yakety Sax (the chase song from the Benny Hill Show) and Entrance of the Gladiators (the clown juggling unicycle song). The tunes are stored as a series of distinct notes..... Listed under: [Projects, Sound - Audio Projects](#)





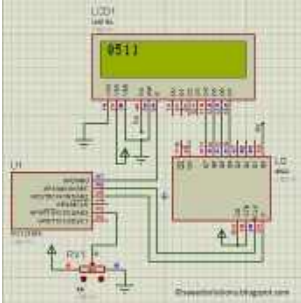

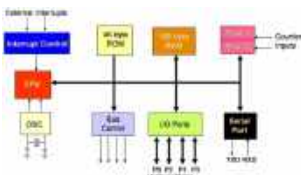
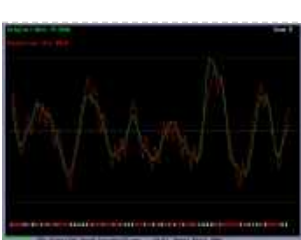
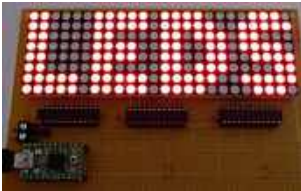

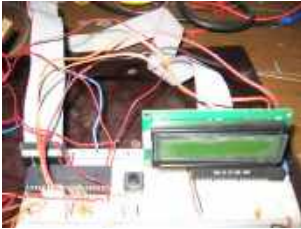

1494.



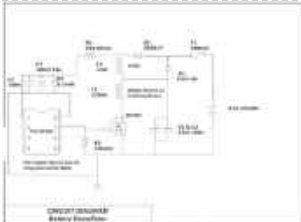
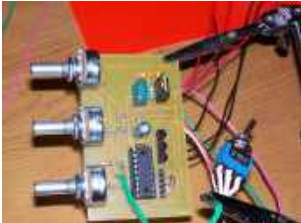







[Digital thermometer with auto saving log file in excel by Pic microcontroller](#) Digital thermometer with auto saving log file in excel by Pic microcontroller is vary advance, useful and realistic project. The implementation filed of this project is wide. Now a day's atmospheric prediction saves lots of life. And for getting wright prediction we have to analysis..... Listed under: [Temperature Measurement Projects](#)



1495.  [Underground locator generator for Radiodetection using PIC16F628](#) Introduction I obtained an early vintage Radiodetection® RD400 "LLTS" Precision Line Trace unit for a very low price through eBay. The RD400 is the receiver portion of a transmitter/receiver pair that comprise an underground cable locator system. Because the matching transmitter was not available (hence..... Listed under: [Projects](#), [Radio Projects](#), [Sensor - Transducer - Detector Projects](#)
1496.  [PIC12F675 ADC code and Proteus simulation](#) This post provides the ADC code using PIC12F675 microcontroller. This code is written in C language using MPLAB with HI-TECH C compiler. You can download this code from the 'Downloads' section at the bottom of this page. It is assumed that you know how to interface..... Listed under: [Interfacing\(USB - RS232 - I2c -ISP\) Projects](#), [Projects](#)
1497.  [PIC12F675 internal EEPROM code and Proteus simulation](#) This post provides the internal EEPROM reading and writing code for PIC12F675 microcontroller. As we know, PIC12F675 microcontroller has 128 bytes of built in EEPROM data space with an address range of 0x00 to 0x7F. This code is written in C language using MPLAB with HI-TECH..... Listed under: [Memory - Storage Projects](#), [Projects](#)
1498.  [Life Size Operation Game using PIC16F877 microcontroller](#) Life Size Operation Game As a child I loved the Milton Bradley Operation game, the buzzer always scared me when it went off, but it was fun. The object of the Operation game is to remove a body part with out touching the tweezers to..... Listed under: [Game - Entertainment Projects](#), [Projects](#)
1499.  [Major Electronic Peripherals Interfacing to Microcontroller 8051](#) Interfacing is one of the important concepts in microcontroller 8051 because the microcontroller is a CPU that can perform some operation on a data and gives the output. However to perform the operation we need an input device to enter the data and in turn..... Listed under: [Interfacing\(USB - RS232 - I2c -ISP\) Projects](#)
1500.  [Record+play fast 1bit sound on a PIC!](#) BTc "Binary Time constant" algorithm. A system to record and/or play sound in a bitstream format using just one digital output pin. This is a sound playback system for a PIC or any other microcontroller. It uses a clever encoding system to mathematically model the..... Listed under: [Sound - Audio Projects](#)
1501.  [Multifunction RGB LED controller using PIC12F675](#) multifunction RGB LED controller using low cost PIC12F675 microcontroller. features: 1, 4+1 mode operation a single potentiometer and single button switch used for multiple operation 2, EEPROM Memory option for mode selection :- the last mode will be saved . 3, mode1 automatic hue saturation..... Listed under: [LED Projects](#)
1502.  [One-chip 11x10 LED matrix. using pic microcontroller](#) This project is pretty cool for a few reasons, and driving a huge LED matrix with a single 8-bit controller is just one of them. The idea was born when I bought 120 LEDs of the wrong type, and decided to do something with them..... Listed under: [LED Projects](#)
1503.  [How to Simulate PIC Microcontroller in Proteus Design Suite 8](#) This is our PIC Microcontroller tutorial series. We have already discussed basic beginners guide to PIC. Now let's see how to simulate the PIC microcontroller?PIC simulation is the important step that you should do before practical implementation of any microcontroller projects. As Circuits Gallery covers..... Listed under: [Interfacing\(USB - RS232 - I2c -ISP\) Projects](#)
1504.  [Making "The LCD Expansion Board" for PIC18F4520 using pic microcontoller](#) In this tutorial I you show you how to make a very useful expansion board for our PIC development board. It will be a Do It Your self (DIY) LCD Expansion board. The expansion board can be plugged into the PIC development board to add..... Listed under: [LCD Projects](#)

1505.  [Lecture 43 : Interfacing PIC16F877 Microcontroller with an LCD](#) Aim To interface LCD (Displaytech 162A) with PIC16F877 microcontroller and to display "IITK" in the Liquid Crystal Display (LCD). Components/Softwares MPLAB IDE (PIC microcontrollers simulator) PIC BURNER 3 with software to load the code LCD (Displaytech 162A) Computer System with Windows operating system and RS 232..... Listed under: [LCD Projects](#)
- 
1506.  [24 Channel USB Connected LED Controller, upto 1A per Channel using PIC18F4550](#) 24 Channel USB Connected LED Controller, upto 1A per Channel This device is designed to be a versatile high-current LED controller, with the ability to sink or/and source currents up to 1A per channel with dissipation of up to 2.5w per channel. The various jumpers..... Listed under: [Game - Entertainment Projects](#), [Home Automation Projects](#), [Interfacing\(USB - RS232 - I2c - ISP\) Projects](#), [LED Projects](#), [Projects](#)
- 
1507.  [The VGA Test Box using pic18f452 Microcontroller](#) The goal of this project is to create a device that is capable of outputting VGA signals to a CRT monitor in order to display figures, text and characters. Timing is a core essential in this project. If the signal is off by even 1 microsecond,..... Listed under: [Home Automation Projects](#), [Video - Camera - Imaging Projects](#)
- 
1508.  [Programming a Picaxe 08m chip](#) After I got my Arduino I felt the urge to brush up on my general electronics knowledge. The last time I'd really played with any circuits was back in about 1994 when I was studying my Technology GCSE – which now is quite a long..... Listed under: [Projects](#)
- 
1509. [Simple USB to RS232 adapter on pic18f2455](#) Overview This adapter allows you to interface with your car's OBD-II bus. It provides you a USB interface using the ELM327 command set and supports all major OBD-II standards: SAE J1850 PWM SAE J1850 VPW ISO 9141-2 ISO 14230-4 ISO 15765-4 CAN Hardware You do..... Listed under: [Interfacing\(USB - RS232 - I2c -ISP\) Projects](#)
- 
1510.  [PIC12F629 Lead-Acid Battery Desulfator](#) Hi everyone, After reading so many articles on Battery desulfator i've decided to come out with my version of Battery desulfator using Microchip base micro-controller using PIC12F629 or PIC 12F675. "Please pardon my english" .I don't really have time to check for minor grammatical errors..... Listed under: [Battery Projects](#)
- 
1511.  [Laser show for poor man using PIC18F1220 microcontroller](#) Laser show for poor man Here's another useless but cool looking "must build" gadget for every romantic geek. Let me introduce PIC microcontroller based three axis laser spirograph. Step 1 Gathering stuff Design is quite simple and employs regular parts and components but you are..... Listed under: [Medical - Health based Projects](#), [Motor Projects](#), [PWM Projects](#)
- 
1512.  [Simple 3 Resistor PIC Programmer](#) Micro-controllers play a very important role in electronics, as they are able to perform tasks in automation, control, image processing, among others. Their usage is immense. There are various families of micro-controllers, one of those is the Microchip's PIC (Peripheral Interface Controller). PICs are very..... Listed under: [Microcontroller Programmer Projects](#)
- 
1513.  [RF Modem Robotics Project using PIC16F84 microcontroller](#) RF is just way too cool not to use in your designs. But if you're a newbie like me it is difficult to successfully build solid RF transmitters and receivers. When I started out I didn't realize that the larger breadboard I was working off..... Listed under: [Projects](#), [Robotics - Automation Projects](#)
- 
1514.  [Serial Data Logger using PIC16F688](#) The data logger consists of a simple op-amp amplifier circuit that amplifies the signal and sends it to be digitized by a PIC16F688 microcontroller, serialized, and sent to the computer's serial port via a MAX232 serial driver: I guess you are already wondering about some..... Listed under: [Interfacing\(USB - RS232 - I2c -ISP\) Projects](#), [Projects](#)
- 
1515.  [Cheap PIC controlled Helmet Camera using Sony LANC \(Good for Extreme Sports\) using PIC16F690](#) Cheap PIC controlled Helmet Camera using Sony LANC (Good for Extreme Sports) This Instructable will show you how to make a cheap Helmet Camera which can be controlled via a remote so your main camera can stay safely in your ruck sack. The controller can..... Listed under: [Other Projects](#), [Projects](#)
- 
1516.  [Building A Robot: Motor Control](#) Since we now have a beautiful robotic chassis, we're ready to continue our Building A Robot series, and get serious with some motor control. This second part of building a robot is perhaps the most crucial as it will define what type of control we..... Listed under: [Motor Projects](#), [Robotics - Automation Projects](#)
- 
1517.  [Stroop Game using PIC16F628 Microcontroller](#) This project has been adapted from an experiment by John Ridley Stroop, who published his work in 1935. Basically it is a "trick." It is a trick in that you are required to answer a question at a "second level of thinking." In our test..... Listed under: [Game - Entertainment Projects](#), [Projects](#)



1518.  [Using the ChipKIT Basic I/O Shield With Analog RGB Strip LEDs](#) A few months ago I wrote a blog post about the chipKIT Basic I/O Shield and used Analog RGB Strips to demonstrate the the open drain FETs. This post is to give details on how to wire up the strip LEDs to the I/O Shield..... Listed under: [chipKIT Projects](#)
- 
1519.  [COMBINATION LOCK FOR SAFE using PIC16F628](#) Introduction This program is a simple combination lock that I designed for an old Sentry® fire safe that was given to me without any lock electronics. I created a front panel with a keyboard and microprocessor with a six-digit combination sequence. Details The LED flashes..... Listed under: [Projects](#), [Security - Safety Projects](#)
- 
1520.  [Using LabVIEW LINX and ChipKIT WF32 to Control an LED Strip](#) This Instructable will go over the steps involved in controlling the WS2812 LED strip using LabVIEW, LabVIEW MakerHub LINX, and chipKIT WF32. Note - This project can be done using the LabVIEW Physical Computing Kit which contains both LabVIEW Home Bundle and chipKIT WF32 here..... Listed under: [chipKIT Projects](#)
- 
1521.  [The Weeder Frequency Counter using PIC16F84](#) This is a port by Peter Cousens to the PIC 16F84 of the 50Mhz Frequency counter kit {originally available} from Weeder Technologies . Since it uses a base PIC that is easily programmable, and provides a usefull bit of bench test equipment at very low..... Listed under: [Clock and Timer Projects](#)
- 
1522.  [ChipKIT Parking Obstacle Sensor](#) I've always thought it would be nice to have a car with a parking sensor. I don't want to spend that kind of money until I pay off my student loans. However I do have the materials to make one myself thanks to a class..... Listed under: [chipKIT Projects](#)
- 
1523.  [Uploading Firmware to Your ChipKIT Boards](#) There may come a time in your chipKIT explorations when you have to put some new firmware onto your board. Well, fear not. This Instructable will go through how to load firmware onto your board. (We're gonna be using the WF32) In order for us..... Listed under: [chipKIT Projects](#)
- 
1524.  [Closed-Caption Decoder using PIC16C84](#) This is a closed-caption decoder with serial output based on a Microchip PIC16F628A. The internal comparators of the PIC16F628A are used to implement a peak detector and data slicer. The hardware was designed by Richard Ottosen, and the firmware was written by Eric Smith. This..... Listed under: [Interfacing\(USB - RS232 - I2c -ISP\) Projects](#), [Projects](#)
- 
1525.  [Addressable LEDs \(WS2812\) on ChipKIT](#) There has not been a simple addressable LED library for PIC32 microcontrollers until now! The PICxel library is an MPIDE library that handles the timing required to use addressable LEDs (WS2812, WS2811) or more commonly known as Adafruit Neopixels. Going through through a couple steps..... Listed under: [chipKIT Projects](#)
- 
1526.  [Using PicBasic with the PIC16F84 PIC Microcontroller](#) This article shows how to use the PIC16F84 microcontroller with PicBasic to design a quick & effective, serially controlled, I/O-Expander. Using PicBasic makes developing handy single-chip devices like this extremely simple. If you're spending all your time programming in assembler, you'll appreciate how simple PicBasic..... Listed under: [Other Projects](#)
- 
1527.  [Electronic Security System With RTC and User Define Pin Code](#) Hi Guys! This is a project that I made using pic microcontroller its an Electronic PIN Code Security System with real time clock and user define pin code features, this page contains all the details to make one yourself. ITS WORKING AND CONCEPT: Well by..... Listed under: [Security - Safety Projects](#)
- 
1528.  [Using WS2812 LEDs With ChipKIT Max32](#) With all LEDs you will need a power supply, some sort of way to send a signal (usually a microcontroller) and method of connecting the LED to your system... Admittedly, that sort of explanation is all things pretty vague (as a description), so instead it's..... Listed under: [chipKIT Projects](#)
- 
1529. [PIC PAL Video Library using pic18f4620](#) If you are into PICs, you maybe tried one day or another to build a software video processor, either for fun or for a project. If you tried to generate video signals, you surely know some of this web pages : Rickard Gunees PIC PONG page..... Listed



under: [Video - Camera - Imaging Projects](#)

1530.



[IRK! Infrared Remote Controlled USB Keyboard Without Keys using PIC18F2550](#) IRK! Infrared Remote Controlled USB Keyboard Without Keys IRK! is a USB keyboard, without keys, that you can operate just by using your LEARNINGinfrared remote control.I created it to allow me to control my MythTV home theater PC with my LEARNINGinfrared remote control instead of..... Listed under: [Interfacing\(USB - RS232 - I2c -ISP\) Projects](#), [Internet - Ethernet - LAN Projects](#), [Projects](#)

1531.



[Setting Up LabVIEW to Interface With ChipKIT](#) This instructable is meant to be a quick tutorial on installing LabVIEW, and hooking it up to a chipKIT. Documentation on how to do this already exists at LabVIEW Hacker.com. This instructable links to the information presented in the source, and puts it in instructable..... Listed under: [chipKIT Projects](#)

1532.



[Getting Started With the ChipKIT WF32 \(LabVIEW\)](#) This in-depth guide will go over the steps required to connect the chipKIT WF32 to LabVIEW using LabVIEW MakerHub LINX. LINX is used to interact with common embedded platforms like Arduino, chipKIT and myRIO. Digilent sells a bundle that includes the chipKIT WF32 and LabVIEW..... Listed under: [chipKIT Projects](#)

1533.



[Programming Your Chipkit Dp32 Using the Arduino IDE](#) chipKIT boards typically have far more memory and computing power than many Arduino boards, and as a result, they are so much better at manipulating data. On the other side, the Arduino IDE is easy to use and understand. So what if we could..... Listed under: [chipKIT Projects](#)

1534.

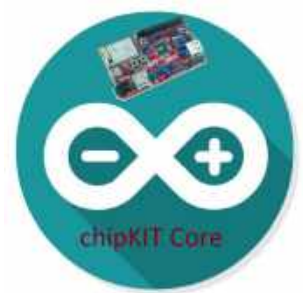

[How to Install ChipKIT Core](#) For those of you with a chipKIT board, I have good news! If you like using the Arduino IDE instead of MPIDE, your dreams have become a reality with chipKIT-core (currently in beta). You can now program all of the chipKIT boards directly from within..... Listed under: [chipKIT Projects](#)

1535.



[Ultrasonic Obstacle-avoiding Robot](#) This is my attempt at designing and building an obstacle avoiding robot! RekaBot (named after a fairy :) can detect obstacles with an ultrasonic sensor that can move around with help from a servo. Based on the measurements she takes, the tracks are driven..... Listed under: [Robotics - Automation Projects](#)

1536.



[Starting a Project in MPLAB X for ChipKIT Products](#) This tutorial comes right after my Installing MPLAB X tutorial, so if you haven't installed MPLAB X and the XC32 compiler, check that one out first. In Arduino, programming a board is as simple as selecting that board, and picking the port it's using. That's..... Listed under: [chipKIT Projects](#)

1537.



[Making of PIC18F452 Micro-Controller Development/Generic Board](#) Our instructable shows how to create a generic board of PIC18 micro-controller which is further used in advanced embedded projects as there is a number of PIC micro-controller applications .e.g. microwave ovens, multimedia devices, medical and health based equipment e.g. blood-pressure meter, UPS, Power..... Listed under: [Development Board - Kits Projects](#)

1538.



[How to create custom characters on 16x2 LCD using PIC18F4550](#) The 16x2 character LCD can also be used to display custom characters other than numerals, alphabets & special characters. Refer LCD interfacing with PIC. Some special shapes like hearts, arrows, smileys etc. can easily be displayed on the 5x8 pixel pattern of character LCD. These..... Listed under: [LCD Projects](#), [Projects](#)

1539.

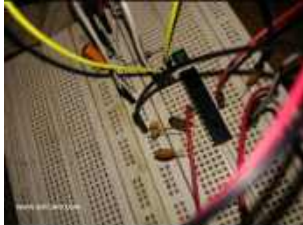

[Pinguino Project \(a PIC Microcontroller Based Arduino #No Programmer Required\)](#) Hey Guys i am Back after 2 months with Awesome Project,This is a Complete tutorial to make PIC Microcontroller based Arduino ,which can run Arduino Programs on PIC18F4550 or PIC18F2550 Microcontroller , one advantage on this microcontroller is ,it does'nt require any External Programmers, Since..... Listed under: [Microcontroller Programmer Projects](#)



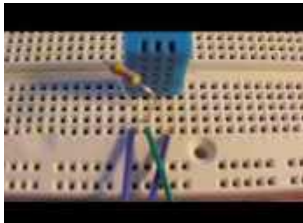





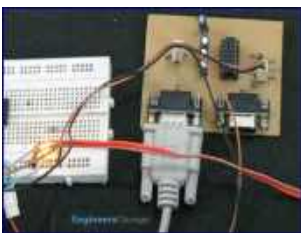

1540.

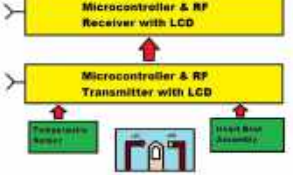

[DHT22 \(AM2302\) Digital Humidity and Temperature Sensor Proteus Simulation](#) Like the DHT11, the DHT22 is a digital humidity and temperature sensor which has more benefits than DHT11 like: High precision and range. If we want to understand this topic we have to read the DHT22 datasheet and see how this device works and its..... Listed under: [Temperature Measurement Projects](#)



1541.  [Interfacing LCD and Keypad with PIC16F877A Microcontroller](#) Interfacing LCD and Keypad are one of the important interfacing concepts of PIC microcontroller since both the input and output element can form a complete embedded system design. This tutorial is about teaching you how to get input values from keypad by polling method..... Listed under: [LCD Projects](#)
1542.  [Temperature controlled fan using PIC 16F877A](#) You might have come across several applications where we need to control a specific device based on analog parameter. This Embedded system works in a similar concept where we are about to control the speed of a DC motor using based on the external temperature..... Listed under: [Temperature Measurement Projects](#)
1543.  [Transmitting and receiving data using UART protocol PIC Microcontroller](#) UART or serial communication is one of the important protocol used by the Microcontrollers to transmit and receive data from the external devices. Almost every controller is equipped with this protocol to make transmission and reception easier just using two pins. This tutorial will teach..... Listed under: [LCD Projects](#)
1544.  [4 Bit LCD interfacing and programming with PIC Microcontroller](#) LCD displays operate in two modes 4 bit and 8 bit mode. We all might have been familiar with 8 bit mode which is used widely in several systems. But 4 bit mode is something which many of us is not aware of. This mode..... Listed under: [LCD Projects](#)
1545.  [A brief overview of Allegro ACS712 current sensor using PIC16F1847 \(Part 1\)](#) Sensing and controlling current flow is a fundamental requirement in a wide variety of applications including, over-current protection circuits, battery chargers, switching mode power supplies, digital watt meters, programmable current sources, etc. One of the simplest techniques of sensing current is to place a small..... Listed under: [Projects, Sensor - Transducer - Detector Projects](#)
1546.  [Tiny Remote for iRobot Roomba using PIC12F629](#) Description The Tiny Remote is a very compact infrared remote control with only two buttons to control an iRobot Roomba. It produces three different infrared control signals that the robot interprets as Clean, Spot and Virtual Wall/Lighthouse. The circuit is built mostly using SMD components to..... Listed under: [Projects, Robotics - Automation Projects](#)
1547.  [PICJazz 20PIN Learning and Development Board](#) The PICJazz 20PIN board from ermicro is designed to be used both as the Microchip PIC microcontroller learning and development board. The PICJazz 20PIN board is stand alone microcontroller module equipped with the latest 8-bit class Microchip midrange and high performance such as PIC16F690 or..... Listed under: [Development Board - Kits Projects](#)
1548.  [PIC16F84A software UART \(bit banging\) code and Proteus simulation](#) This post provides the software UART (Bit Banging) code for PIC16F84A microcontroller (e-g to connect PIC controller with PC using serial adapter). As we know, PIC16F84A microcontroller doesn't have built in UART module, so we can create UART functionality in it's software. This post provides the details of how..... Listed under: [Interfacing\(USB - RS232 - I2c -ISP\) Projects, Projects](#)
1549.  [Programmable IR remote control using PIC16LF877](#) NEC-SIRCS-JAPAN-RC5-SAMSUNG compatible, multiprotocol infrared remote control. Replaces up to 6 existing remote controls into one. With manual learning function, LED display and/or LCD. 2V6-3V2, low power (sleep function) More protocols will be added later if needed (DENON, DAEWOO, MOTOROLA, RECS80.) Components: PIC16LF877-04/L (4Mhz PLCC Package),..... Listed under: [Internet - Ethernet - LAN Projects, Projects, Sensor - Transducer - Detector Projects](#)

1550.  [PIC Analog to Digital Converter C Programming](#) The PIC16F690 microcontroller is one of Microchip midrange 8-bit microcontroller that has a built in 10-bit resolution of Analog to Digital Converter (ADC) peripheral. The ADC is one of the important features that enable us to digitize our analog world. Usually we use the electronic..... Listed under: [Microcontroller Programmer Projects](#)
1551.  [Lab 4: Interfacing a character LCD using PIC16F688](#) Description HD44780 based LCD displays are very popular among hobbyists because they are cheap and they can display characters. Besides they are very easy to interface with microcontrollers and most of the present day high-level compilers have in-built library routines for them. Today, we will..... Listed under: [Interfacing\(USB - RS232 - I2c -ISP\) Projects](#), [LCD Projects](#), [Projects](#)
1552.  [Introduction to the Microchip PIC C Programming](#) The PIC microcontroller is quite popular in industrial and hobbyist, some of the newest 8-bit midrange Microchip PIC microcontroller with nanoWatt technology is PIC16F690, this 20 pin microcontroller has a built in peripherals such as ADC, UART, PWM, I2C, analog comparator and with 7KBytes program..... Listed under: [Microcontroller Programmer Projects](#)
1553.  [PIC based wireless temperature and heartbeat read-out](#) Microcontroller based wireless temperature and heartbeat read out suitable for a operation in a small office/home environment . This system is suitable to operate with Visual LCD. Many individuals or organisations may, for various reasons,wish to use electronic surveillance technique at some time or another. This idea is to..... Listed under: [Wireless Projects](#)
1554.  [Powering Your Microcontroller's Base Project](#) A good power supply is an essential subject to the microcontroller's base project; it's like a heart that gives a life to our microcontroller. Sometimes we take it for granted the important of having an adequate power supply to our microcontroller project and this can..... Listed under: [power - energy projects](#)
1555.  [A DIY indoor thermometer plus hygrometer using PIC16F688](#) This project is about building a microcontroller-based digital room thermometer plus hygrometer that displays temperature and relative humidity on 4 large (1 inch) seven segment LED displays which adjust their brightness level according to the surrounding illumination. It consists of a closed loop system that..... Listed under: [How To - DIY - Projects](#), [Metering - Instrument Projects](#), [Projects](#), [Temperature Measurement Projects](#)
1556.  [Large Dancing Robot using PIC16f877A microcontroller](#) Large Dancing Robot Build a large dancing robot. This was supposed to be a walking robot, but it more kinda beebopped around. video on last step. Build a Prototype First, The \_Prototype\_: Before you make a large, high power robot, it's good to make a..... Listed under: [Projects](#), [Robotics - Automation Projects](#)
1557.  [How to make\(build\) a Calculator using Pic16f877 microcontroller](#) alculator with Pic 16f877 microcontroller is a comprehensive project. Comprehensive in the way that Code is lengthy and logical. It covers all the aspects of programming and interfacing of 16x2 lcd and 4x4 keypad with pic Microcontrollers. So you should be good in programming, if..... Listed under: [Calculator Projects](#)
1558.  [Introduction to Microchip PIC Assembler Language – Part 1](#) Learning the assembler language is one of the essential skills that still required in the embedded system, although the major drawback using the assembler language is; it's required more learning curve time compared to the higher level language but once you acquainted with one type..... Listed under: [Phone Projects](#)
1559.  [Traffic Message Channel receiver using PIC18F8722](#) Main roads traffic status and incident report and display. Technical specifications: Dual display: colour road map (left) and detailed text messages (right) both with LED backlight. Up to 120 TMC messages are stored in memory. Auto/manual TMC message scrolling. GPS position locator/follower optional. Map navigation..... Listed under: [Car Projects](#), [Interfacing\(USB - RS232 - I2c -ISP\) Projects](#), [LCD Projects](#), [Projects](#), [Security - Safety Projects](#)
1560.  [Building BRAM your first Autonomous Mobile Robot using Microchip PIC Microcontroller – Part 1](#) Have you ever thought that most of our perception about the robot is based on the Hollywood movie! The famous 3CPO and R2D2 from Star Wars until the little cute garbage compacting robot named WALL-E; all of these machines are example of our dreams or..... Listed under: [Robotics - Automation Projects](#)
1561. [LED flasher using PIC16C84 Microcontroller](#) This is my first simple PIC program. It will flash an LED continuously at approximately 1Hz. It is a very simple loop that delays for 500 milliseconds (half a second) with the LED on, and then delays for 500ms with the LED off. Thus, the..... Listed under: [LED Projects](#), [Projects](#)





1562.



[Behavior Based Artificial Intelligent Mobile Robot with Sharp GP2D120 Distance Measuring Sensor – BRAM Part 2](#)

What is the intelligent anyway; could we categories how the bees building their tiny hexagonal compound nest, ants searching for their food or birds migration using precision navigation over continental are the intelligent acts; or we as the human being with our cultures and civilizations..... Listed under: [Robotics - Automation Projects](#)

1563.



[TRACK CONTROLLER FOR AWANA® GRAND PRIX using PIC16F628](#)

Introduction This project is for the hobbyist who wants to build a measurement and display unit for an Awana Grand Prix® track (also known as a Pinewood Derby track.) The racetrack for which I designed this unit is a 4-car track. A car is approximately..... Listed under: [Other Projects, Projects](#)

1564.



[Introduction to the Embedded System with PICAXE Microcontroller](#)

These days we are living and surrounding by many tiny computers called embedded products. Unlike the general purpose desktop computer that we use for browsing or typing our email, this tiny computer is designed to do only a limited specific task. We could easily found..... Listed under: [Other Projects](#)

1565.



[Servo Camera Switch using PIC12F675 microcontroller](#)

This document describes the complete design for a camera switch that uses a servo to activate the shutter. This page include links to the complete circuit diagram, the .HEX file required to program the 12F675, and complete construction details. The switch consists of a PIC..... Listed under: [Projects, Video - Camera - Imaging Projects](#)

1566.



[PIC18 Pulse Width Modulation \(PWM\) DC Motor Speed Controller with the RPM Counter Project](#)

Equipped with sophisticated Enhanced Capture/Compare/PWM (ECCP) peripheral the Microchip PIC18F14K50 microcontroller could produce up to four PWM channels output. The enhanced PWM (Pulse Width Modulation) mode in ECCP peripheral is capable to drive the full bridge DC Motor circuit directly both in forward or reverse..... Listed under: [Motor Projects](#)

1567.



[TIMED DISCHARGE ADAPTER using PIC16F628](#)

Introduction This program is an experimental timed-discharge adapter for a Vericom control panel used with an Orenco Systems AdvanTex® wastewater treatment system (sewage filtration system) marketed by Wastewater Technologies, Inc. Although the Vericom firmware is capable of modification to provide timed-discharge capability by a firmware..... Listed under: [Projects](#)

1568.



[Build Your Own Simple and Easy PICAXE Microcontroller Based Photovore Robot](#)

Building a simple and easy microcontroller based robot is always a fascinating topic to be discussed, especially for the robotics newbie enthusiast. On this tutorial I will show you how to build your own microcontroller based robot which known as a photovore or you could..... Listed under: [Robotics - Automation Projects](#)

1569.



[An Arduino me-too-alike for PIC16F873A](#)

We've all done it – looked sideways with not a little envy at a range of add-ons for a power tool, and wished that they were available for the one we bought. There is no 'standard' footprint for a PIC Micro-controller development/experimental board. Vendors have..... Listed under: [Development Board - Kits Projects, Projects](#)

1570.



[Building your own Simple Laser Projector using the Microchip PIC12F683 Microcontroller](#)

The 8 pins PIC12F683 microcontroller is one of the smallest members of the Microchip 8-bit microcontroller families but equipped with powerful peripherals such as ADC and PWM capabilities. This make this tiny microcontroller is suitable for controlling the DC motor speed. In order to demonstrate..... Listed under: [Motor Projects](#)

1571.



[PIC based WWVB clock](#)

Introduction There are many DIY versions of WWVB clock designs available on the web. Commercial "atomic" clocks are inexpensive and widely available, but I wanted to try my hand at designing one to gain insight into WWVB reception and to learn a little about programming..... Listed under: [Clock and Timer Projects](#)

1572.  [Stepping Into the 16-bit World with the Microchip 16-bit PIC24F16KA102 Family Microcontroller](#) One of the commonly asked questions when we move to the bigger and powerful 16-bit microcontroller is do we really need it? As the 8-bit microcontroller is already suite almost all of our needs from a simple blinking LED to more sophisticated embedded application such..... Listed under: [Other Projects](#)
1573.  [PIC16F84A discolight effect with bass beat control](#) Introduction External circuit converts bass beat of music into pulses.The motor is controlled by them. If theres bass beat recognised then the motor rotates one direction(in full stepping) for a predefined time then stops. If the second beat comes in then it rotates again for..... Listed under: [Motor Projects](#)
1574.  [The LM324 Quad Op-Amp Line Follower Robot with Pulse Width Modulation](#) Designing a simple and yet functional Line Follower Robot (LFR) is always a fascinating and challenging subject to be learned, the LFR actually could be implemented in many ways start from a simple two transistors to a sophisticated PID (Proportional, Integrate and Differential) which take..... Listed under: [Robotics - Automation Projects](#)
1575.  [Bit-Banging Serial Interfaces for the Low-End and Mid-Range PICMicros using PIC16F84](#) When I designed the "YAP" for the "YAP" PICMicro programmer presented in "Programming and Customizing the PIC Microcontroller", I felt that the serial interface provided in "execution mode" of the programmer would be very useful for people developing their own software. With this interface, the..... Listed under: [Interfacing\(USB - RS232 - I2c -ISP\) Projects](#), [Projects](#)
1576.  [How Seven Segment Display Multiplexing with PIC Microcontroller for Electronic Sign](#) Hi there, today I'm gonna to give you some PIC interfacing circuit. We have already seen how to connect LCD display to PIC MCU which has a great role in electronic display board industry. By the way how do we interface 7 segment displays to..... Listed under: [Interfacing\(USB - RS232 - I2c -ISP\) Projects](#)
1577.  [The Line Follower Robot with Texas Instruments 16-Bit MSP430G2231 Microcontroller](#) When Texas Instruments (TI) introduced their new value line 16-bit microcontroller complete with the programmer and development board named MSP430 Value Line LaunchPad in the mid of 2010 for only USD 4.30 include the shipping cost, this make it as the cheapest programmer and development..... Listed under: [Robotics - Automation Projects](#)
1578.  [Prototype: Openbench Logic Sniffer logic analyzer using pic microcontoller](#) Openbench Logic Sniffer is an open source logic analyzer. It's designed to support the SUMP logic analyzer software at the lowest possible cost. Download the source and design files from the Gadget Factory project page. This project started in the comments on a post. Initial..... Listed under: [Other Projects](#)
1579.  [Logic Probe Plus using PIC12F683](#) This project is based on a probe logic states, capable of measuring levels from TTL (5v) to state levels of PLC's (24v). For this we have employed the use of the PIC 12F683 microcontroller, which by its nature is capable of operating at low voltages,..... Listed under: [Metering - Instrument Projects](#), [Projects](#)
1580.  [Interfacing the Microchip PIC18F Microcontroller Master Synchronous Serial Port \(MSSP\) to various I2C Devices](#) The Inter-Integrated Circuit or I2C (read as I square C) bus has been introduced in 1980 by Philips, and has become a de-facto world standard for data exchange between Microcontroller and various devices such as temperature sensor, ADC (analog to digital converter), DAC (digital to..... Listed under: [Other Projects](#)
1581.  [PIC Based Message wand](#) The project uses flashing LEDs to present shot message in the air by swinging a wand around above the head. A perfboard is used to construct the circuit that is powered by 2 coin cells type CR2016. The power fluctuations from excessive load on the..... Listed under: [LED Projects](#)
1582.  [H-Bridge Microchip PIC Microcontroller PWM Motor Controller](#) One of the advantages using the Microchip PIC microcontroller Pulse Width Modulation or PWM for short is; this PWM peripheral circuit is designed to control the DC motor using the full bridge mode PWM feature. The PWM peripheral works by supplying the correct signal to..... Listed under: [PWM Projects](#)
1583.  [LEDactus using PIC18F1320 Microcontroller](#) The LEDactus is my version of a dry climate niche dweller like a cactus. LEDactus is immobile and attempts to survive by creating a pleasant display. This is of course in the hopes that passersby will be so entranced that they will build the LEDactus'..... Listed under: [LED Projects](#), [Projects](#)
1584. [Controlling a Servo with a PICAXE and an IR Sensor](#) Learn how to combine a PICAXE, IR sensors, and a servo motor to create a device that responds to a moving stimulus. Spoilers: I hook it up to eyeballs that can follow a finger. Related Information Servo Motor Control with an





Arduino Servo Control with..... Listed under: [Motor Projects](#)



1585. [Bootloader for 16F87x PIC Microcontrollers](#) A bootloader enables download of hex-files directly into the flash-memory of a PIC or other microcontroller. The bootloader receives the user program via the PIC's UART and writes it directly to the program memory (self programming). This feature greatly speeds up the development process, because..... Listed under: [Interfacing\(USB - RS232 - I2c -ISP\) Projects](#)

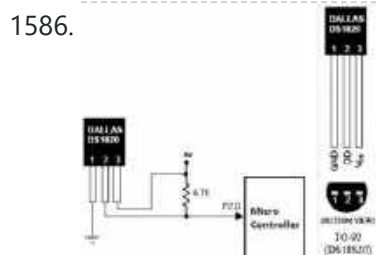

1586. [DS18S20 interfacing with pic and avr microcontroller](#) Microcontroller BoardsRead the temperature in PIC16F/18F Primer Board from temperature sensor ds1820. The PIC16F/18F Primer board uses the ADC pin for reading temperature from temperature sensor ds1820. The reading output is displayed into PC through UART. PIC16F/18F Development Board The PIC16F/18F Development Board is specifically designed to..... Listed under: [Sensor - Transducer - Detector Projects](#)



1587. [A Versatile PIC16F876A Based Robot](#) Design Summary: Our group designed and manufactured a miniature robotic vehicle that conquers various terrains. The vehicle was designed with a track system which is powered by two DC motors. The motors use a Quadruple half H -Driver in order to drive the motors in both directions. The track system incorporates a four bar linkage for each tread..... Listed under: [Projects, Robotics - Automation Projects](#)



1588. [IMAR-3 PC-KEYBOARD ADAPTER FOR SPECTRUM using pic16f84](#) While I was writing some tips to solve problems about Spectrum' keyboard, some guys asked me for the possibility of using a PC-keyboard coupled by adapter. One market solution was launched by 'Sintech', but isn't available the scheme nor the program used by inner microcontroller..... Listed under: [RFID - NFC Projects](#)



1589. [F1 Gantry Race Start Lights using PIC16F684](#) Description Featured in Electronics Weekly Gadget Freak (15/08/2008) The Control board for this project is now available in kit form or fully assembled and tested. Please visit the Picprojects on-line shop for more details This project provides an simple F1 motor racing style 5 light race..... Listed under: [LED Projects, Projects](#)



1590. [Automatic control of street lights](#) Did you ever think that how the street lights automatically turn ON in the night and turn OFF automatically at morning? Is there any person who comes to ON/OFF these lights? The following circuit that described below which perform this job automatically. This circuit employed..... Listed under: [Sensor - Transducer - Detector Projects](#)



1591. [PlayPIC Tutorial Board for the PIC16F84A Microcontroller](#) This is a new design of a tutorial board based on the popular PIC16F84A microcontroller. It features eight single leds, a 7-segment display, an LCD display and five push buttons. It is an ideal solution for the beginner to take his/her first programming steps in..... Listed under: [Development Board - Kits Projects, Projects](#)



1592. [PIC12F675 timer0 code and Proteus simulation](#) This post provides the timer0 code for PIC12F675 microcontroller. This code is written in C language using MPLAB with HI-TECH C compiler. You can download this code from the 'Downloads' section at the bottom of this page. It is assumed that you know how to blink an..... Listed under: [Clock and Timer Projects](#)

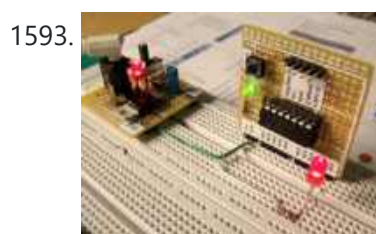

1593. [PIC12F675 timer1 code and Proteus simulation](#) This post provides the timer1 code for PIC12F675 microcontroller. This code is written in C language using MPLAB with HI-TECH C compiler. You can download this code from the 'Downloads' section at the bottom of this page. It is assumed that you know how to blink an..... Listed under: [Clock and Timer Projects](#)



1594. [Digital humidity sensor using PIC microcontroller](#) The percentage of water present in the air is termed as humidity. Water as gaseous state called vapor. As the temperature of the air increases more water vapor can be generate. Humidity measurement in industries is critical because it may affect the business cost of..... Listed under: [Sensor - Transducer - Detector Projects](#)



1595. [Make your own motion sensor alarm with SMS feature using PIC18F2550](#) MikroElektronika demonstrates how to build a simple home alarm system that has the capability of sending SMS to a predefined cell phone number when intrusion is detected. This project is based on StartUSB for PIC board, a small development board for PIC18F2550, which is preprogrammed..... Listed under: [Home Automation Projects, Phone Projects, Projects, Sensor - Transducer - Detector Projects](#)

1596. [Temperature sensor using PIC16F877A microcontroller](#) In this tutorial, we are making a Digital Thermometer using PIC microcontroller and LM35 Temperature Sensor. In this project, we will sense the temperature using LM35 and display it on 16x2 LCD. LM35 Temperature Sensor is

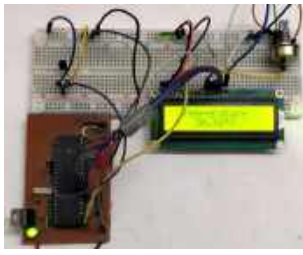

accurate and cheaper and doesn't require any external calibration. The output voltage..... Listed under: [Temperature Measurement Projects](#)

1597.



[Photo film processor](#) On this page you will find the technical information for building the electronic control unit of my homemade film processing machine. To see the rest of this film developing apparatus, look at the relevant article in the photography section of this site. Developing a color..... Listed under: [Video - Camera - Imaging Projects](#)

1598.

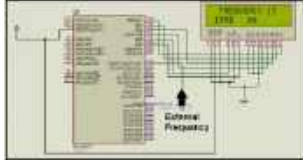

[Digital frequency meter using pic microcontroller](#) Here you will see how easily we can make Digital frequency meter by PIC microcontroller using timer 1. To make this project we need clear idea on timer 1 module of PIC16F877 microcontroller. We need to know how we can configure timer 1 module to..... Listed under: [Metering - Instrument Projects](#)

1599.



[Interfacing 16x2 Lcd With 8051 Circuit Pin Diagrams](#) Microcontroller based electronic circuit diagrams, Electronic circuit diagrams / circuit schematics. if you would like general assistance with a specific design question you may like to try the electrical engineering. Interfacing lcd modules pic microcontrollers., In this tutorial we will learn how we can..... Listed under: [LCD Projects](#)

1600.

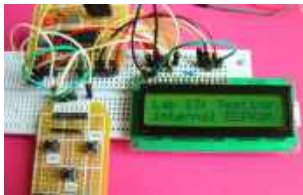

[PIC16F84A internal EEPROM code and Proteus simulation](#) This post provides the internal EEPROM reading and writing code for PIC16F84A microcontroller. As we know[1], PIC16F84A microcontroller has 64 bytes of built in EEPROM data space with an address range of 0x00 to 0x3F. This code is written in C language using MPLAB with HI-TECH C compiler..... Listed under: [Memory - Storage Projects, Projects](#)

1601.

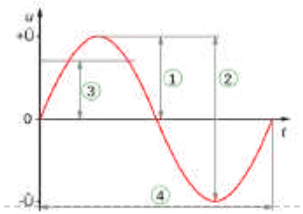

[AC Voltage measurement using PIC16F877A microcontroller](#) Note: Microcontroller PIC16F73 can be used instead of pic16f877a. This time we will see how to measure AC voltage parameters with the help of micro-controller. First we will know about AC voltage parameters, then we will do the whole work step by step. What is AC(Alternating..... Listed under: [Metering - Instrument Projects](#)

1602.



[Transmit & Receive Infrared Signals With Your PC Serial Port using PIC12F508](#) We no longer manufacture or sell the original Air-Byte IR transceiver, so we're releasing the code & circuit design here for hobbyists and students looking to build a simple IR transceiver. Note that the parts used here are not critical. I.E. the NPN darlington transistor..... Listed under: [Interfacing\(USB - RS232 - I2c -ISP\) Projects, Internet - Ethernet - LAN Projects, Projects](#)

1603.



[PIC16F877 timer0 code and Proteus simulation](#) This PIC16F877 microcontroller tutorial answers the question, " How to use timer0 of PIC16F877 and how to handle its interrupts? " Using PIC16 simulator (Proteus) you can verify this PIC timer0 code and change it according to your needs. This code is written in C language..... Listed under: [Clock and Timer Projects](#)

1604.



[LEARN HARDWARE FIRMWARE AND SOFTWARE DESIGN – BRIEF DESCRIPTION](#) Edition 5 of LHFSD [ISBN 978 606 92185 32] has been specifically designed to become an educational/pedagogical manual for teachers, instructors, and also for ordinary citizens. Have no fear, dear readers: LHFSD is still addressed to beginners, since EVERYTHING starts from a white page, and..... Listed under: [Development Board - Kits Projects](#)

1605.

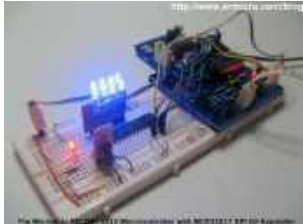

[Using Serial Peripheral Interface \(SPI\) with Microchip PIC18 Families Microcontroller](#) The Serial Peripheral Interface (SPI) is one of the popular embedded serial communications widely supported by many of today's chip manufacture and it considered as one of the fastest serial data transfer interface for the embedded system. Because of its special in/out register configuration, the..... Listed under: [PWM Projects](#)

1606.

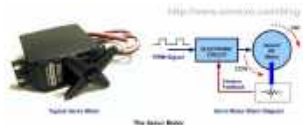

[Basic Servo Motor Controlling with Microchip PIC Microcontroller](#) The servo motor is widely used in model hobbyist such as airplane R/C model for moving the rudder, ailerons, elevators and acceleration control or in the car R/C model for steering and acceleration control. In this tutorial we will learn how to control the servo..... Listed under: [Motor Projects](#)

1607.



[PIC LICK-1 using PIC16F84 Microcontroller](#) This module is so simple, I'm surprised it has not been thought of before. You can fit a PIC16F84A or PIC16F628 and it becomes a "buffered PIC chip." Look at the circuit diagram first to see what the module is doing. It's buffering 5 of..... Listed under: [Development Board - Kits Projects, Projects](#)





1608.

[PIC-based Digital Voltmeter \(DVM\)](#) Introduction This project will describe how to make a simple digital voltmeter (DVM) using a PIC16F688 microcontroller. The range of this DVM is 0-20V, but you can easily increase or decrease the range of input voltage as your requirements after

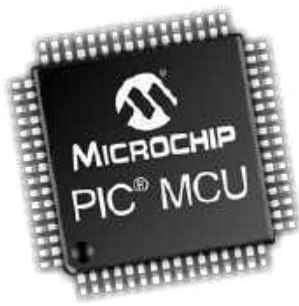

- you understand the voltage scaling..... Listed under: [Metering - Instrument Projects](#)
- 
1609.  [A Digital temperature meter using an LM35 temperature sensor](#) Introduction A digital thermometer is a good choice of project for beginners who just stepped in to the world of microcontrollers because it provides an opportunity to learn using sensors to measure the real world signals that are analog in nature. This article describes a..... Listed under: [Sensor - Transducer - Detector Projects](#)
- 
1610.  [How to work with External \(Hardware\) Interrupts of PIC18F4550](#) Interrupts are special events that require immediate attention. They cause the processor to cease the running task to serve a special task for which the interrupt event had occurred. After the special task is over, the processor resumes performing the original task. The processor can..... Listed under: [How To - DIY - Projects, Projects, Tutorials](#)
- 
1611.  [AquaCont – Aquarium Control using pic microcontroller](#) The AquaCont is an electronic system which permits to manage and to monitor most of the parameters of all the electric devices that can be found in an aquarium. The PIC18F4520 used to realize it, combines a real time clock and a temperature sensor in..... Listed under: [Sensor - Transducer - Detector Projects](#)
- 
1612.  [How to interface 16x2 LCD in 4-bit mode with PIC18F4550](#) The 16x2 character LCD can work in two modes, namely, 8-bit and 4-bit. These modes basically correspond to the number of data pins used in interfacing LCD. 8-bit mode uses all the data lines and has been explained in LCD interfacing with PIC18F4550. In 4-bit..... Listed under: [LCD Projects, Projects](#)
- 
1613.  [Heart rate measurement from fingertip](#) Heart rate measurement indicates the soundness of the human cardiovascular system. This project demonstrates a technique to measure the heart rate by sensing the variation of the blood volume inside a finger artery, which is caused by the pumping action of the heart. It consists of an..... Listed under: [Sensor - Transducer - Detector Projects](#)
- 
1614.  [Pocket Programmer](#) <http://www.bubblesoftonline.com/pocket/pocket.html> HOT! Tony Nixons Pocket Programmer. The Pocket Programmer is a stand alone serial programmer that can program most of the PICmicro® MCU range of microprocessors. (12C6xx, 16Cxxx, 16Fxxx, 18Cxxx) It works from a single 18VDC supply or with 2 X 9 volt batteries. Combine this..... Listed under: [Microcontroller Programmer Projects](#)
- 
1615.  [Business Card PIC Programmer using PIC12F629 microcontroller](#) Business Card PIC Programmer This was my entry for the Hack A Day business card size circuit contest. I just zipped up the files and put them on my website. I'm posting it here because all the other entries seem to be on a blog..... Listed under: [Other Projects, Projects](#)
- 
1616.  [A new multi-function power supply unit for my Embedded Lab](#) One important parameter in embedded system designing is power consumption. This parameter is directly related to the battery lifetime, if the system is to be powered from a battery. In order to determine the power rating of your designed system, you need to know how..... Listed under: [LCD Projects](#)
- 
1617.  [RC5 remote control using PIC12F629](#) All remote controlled projects from this site can be controlled with remote controls which use the RC5 protocol, like the TV-remotes from Philips. When all buttons from such a remote are in use then you could make a remote control by yourself. Your own build..... Listed under: [Home Automation Projects, How To - DIY - Projects, Projects](#)
- 
1618.  [How to use the EQ PIC Development Board Video](#) EQ PIC DEVELOPMENT BOARD. ON-BOARD MODULES. HOW TO CREATE A PROJECT IN MPLAB X AND DOWNLOAD THE CODE ONTO THE EQ PIC DEVELOPMENT BOARD USING A BOOTLOADER. Ghana movies HOW TO CREATE A PROJECT IN MPLAB X AND DOWNLOAD THE HEX FILE ONTO THE EQ..... Listed under: [Development Board - Kits Projects, Projects](#)
- 
1619.  [Having fun with HC08 using pic microcontroller](#) Here is a nice little project for a rainy weekend, all this can be accomplished over a weekend and for under USD 15. This page has gone through several rewrites, mainly to get rid of my 'rant mode' writing, but it seems I just need..... Listed under: [Game - Entertainment Projects](#)
- 
1620. [PIC-Microcontroller C Tool flow Video](#) this video explain about Micro C software for PIC programming ... Listed under: [Microcontroller Programmer Projects, Projects](#)

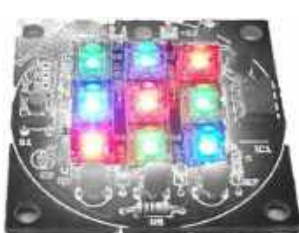

1621.  [How to make a contact-less digital tachometer using IR-light reflection technique](#) Tachometer is a device that measures the rotational speed of any shaft or disc. The unit of the measurement is usually revolutions per minute or RPM. The traditional method of measuring RPM of a rotating shaft was based on velocity feedback concept where a dc..... Listed under: [Metering - Instrument Projects](#)
- 
1622.  [PIC32 Multimedia Expansion Board Review Video](#) Review of the Multimedia Expansion Board for the PIC32 Start Kits from Microchip. In this review I'm going to show the board and it's peripherals, and then I will show a couple of demonstration applications.... Listed under: [Development Board - Kits Projects](#), [LCD Projects](#), [Projects](#)
- 
1623.  [Build a PIC controlled DDS VFO, 0 to 6 MHz using pic microcontroller](#) Files contained in MINIDDS.ZIP: readme.txt Read this first! compplac.pdf Component placement in PDF format schema.pdf Schematic diagram in PDF format top.ps PCB top copper layer in Postscript format bottom.ps PCB bottom copper layer in Postscript format ad9832\_4.asm PIC assembly source code p16f84.inc Needed for assembly..... Listed under: [LCD Projects](#)
- 
1624.  [PIC 18F4550 Motor Controller Video Project](#) In this video, we cover how to breadboard and write the firmware for a motor controller (controlling a servo, 2 DC motors, and a stepper) with the PIC 18F4550. A few notes on this video: -I recorded most of the video during the evening of..... Listed under: [Motor Projects](#), [Projects](#)
- 
1625.  [LM386 based stereo audio amplifier with digital volume control](#) Due to its simplicity (requires minimum external components) and high availability, LM386 is very popular among hobbyists for use in low-voltage audio amplification applications. Most of the time a potentiometer is used at the input side of LM386 to provide a volume control in the..... Listed under: [Sound - Audio Projects](#)
- 
1626.  [A video game with software generated video signal !](#) Introduction I have made the game pong using a pic 16F84 running @ 12MHz. The game Pong was the world's first video game in the early 70's, this is a modern version of it, made with a little bit less hardware than the original version..... Listed under: [Game - Entertainment Projects](#)
- 
1627.  [Simple RS232 to logic level converter for PIC microcontroller](#) The circuit shown will convert logic level voltages to and from RS232 serial voltages levels. For basic serial comms between a Microchip PIC and a PC or other device you generally only need to connect the Gnd, Txd and Rxd lines. This little circuit will..... Listed under: [Development Board - Kits Projects](#), [Projects](#)
- 
1628.  [RGB LED Mood Light Standalone PWM controller for RGB LEDs using PIC12F629](#) This project is an update to the original RGB LED PWM Driver. The new version allows the use of either 5mm LEDs or the square bodied Superflux / Piranah style LEDs. The circuit now uses bipolar transistors rather than MOSFETs which make it more suitable..... Listed under: [Home Automation Projects](#), [LED Projects](#), [Projects](#), [PWM Projects](#)
- 
1629.  [New Earth Time \(NET\) digital clock in recycled retro-modern case using PIC16F627A](#) Ever get confused by GMT, or just wish you had a cooler way to keep track of time? Build a New Earth Time clock! Using a PIC microcontroller, some code, and a couple discrete parts, you too can have a unique timekeeping device to keep..... Listed under: [Clock and Timer Projects](#)
- 
1630.  [00 to 99 minute timer using PIC16F628A microcontroller](#) Last week I was browsing my old backup hard drive and I found a source code for a very simple PIC based digital timer that I made a couple of years ago. The actual hardware of the project isn't with me anymore. I might have..... Listed under: [Clock and Timer Projects](#)
- 
1631. [Universal High-Power LED Driver with 3D-printable Case using PIC16F1823](#) \*\*\* There's a firmware update. Please check out! \*\*\* LEDs are taking over conventional lighting every day. High-power LEDs over 1W are becoming more and more affordable, and I wanted to start using them to replace the lighting fixtures around me. However I realize that..... Listed under: [LED Projects](#), [Projects](#)





1632.



[IKEA Mood-light Conversion using PIC12F683P](#) Introduction This little project was one of my first projects with microcontrollers. First, I made the circuit then, for years, I was wondering what I could do with it, until one day I came across this IKEA plastic bag dispenser. I knew immediately, it would..... Listed under: [Home Automation Projects](#), [Projects](#)

1633.



[LED Microcontroller Debug Module using PIC18F4420](#) When it comes to debugging a microcontroller circuit, there aren't a lot of simple options. Since a microcontroller circuit might have multiple things going on at the same time, measuring voltages with a DMM isn't an option. Using an computerized In-Circuit-Debugger solution is expensive and..... Listed under: [LED Projects](#), [Projects](#)

1634.



[Pingbot – Micro RC Rechargeable Musical Robot Pal using PICAXE](#) Pingbot is a very small (38mm diameter), usb rechargeable, programmable, musical, remote control robot designed for maximum fun and danceability. I've built a few experimental robots in the past and, to be honest, they all looked the part. They were nothing more than circuit boards..... Listed under: [Projects](#), [Robotics - Automation Projects](#)

1635.



[TrH Meter: A DIY indoor thermometer plus hygrometer with adaptive brightness control implemented to 7-segment LED displays](#) This project is about building a microcontroller-based digital room thermometer plus hygrometer that displays temperature and relative humidity on 4 large (1 inch) seven segment LED displays which adjust their brightness level according to the surrounding illumination. It consists of a closed loop system that..... Listed under: [Metering - Instrument Projects](#)

1636.



[How-to: Bus Pirate v1, improved universal serial interface using PIC24FJ64GA002](#) We use the Bus Pirate to interface a new chip without writing code or designing a PCB. Based on your feedback, and our experience using the original Bus Pirate to demonstrate various parts, we updated the design with new features and cheaper components. There's also..... Listed under: [Interfacing\(USB - RS232 - I2c -ISP\) Projects](#), [Projects](#)

1637.



[Making a digital capacitance meter using microcontroller](#) Capacitors are one of the most common passive electrical components that are extensively used in all kinds of electronic circuits. In this project, we will discuss a technique of building a digital capacitance meter using a PIC microcontroller. This project can measure capacitance values from..... Listed under: [Metering - Instrument Projects](#)

1638.



[How to drive a lot of LEDs using PIC12F microcontroller](#) How to drive a lot of LEDs from a few microcontroller pins. Using the fact that many microcontroller pins have three states (+V, GND, or "high impedance", you can drive  $N*(N-1)$  LEDs from N pins. So the little 8 pin microcontroller like a PIC12Fxxx or..... Listed under: [LED Projects](#), [Projects](#)

1639.



[PIC RC Motor Controller \(and example lego robot\)](#) Step 1: Parts List General: RC transmitter/receiver set with at least 3 channels. As is this code only works with stacked PWM signals. I can only say for sure that it will work with traxxas receivers. With modification it could work with any PWM timing,..... Listed under: [Motor Projects](#)

1640.

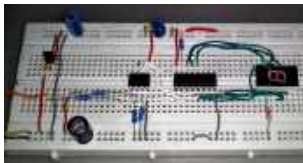

[Digital logic probe for troubleshooting TTL and CMOS circuits](#) A logic probe is considered as a stethoscope for engineers and technicians for debugging digital logic circuits that consists of logic gates, memories, registers, etc. A digital multimeter (DVM) can also be used for such analytical purposes but it gives you the numeric value of..... Listed under: [Other Projects](#)

1641.











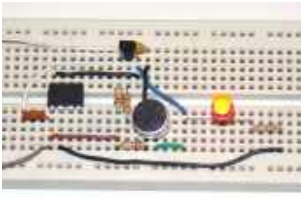
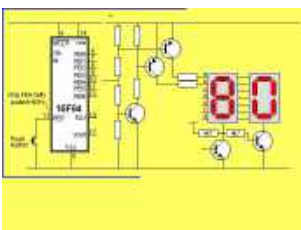

[Message Pump using PIC16F687 microcontroller](#) Brief: The Message Pump A.K.A. the USB to LCD Backpack is a device that allows you to connect a LCD display directly to your computer. It uses a PIC micro-controller, to drive the LCD and a FTDI USB to serial chip to connect to your..... Listed under: [LCD Projects](#), [Projects](#)

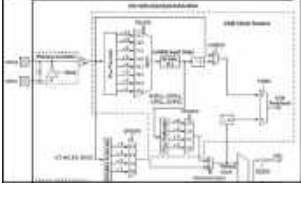
1642.

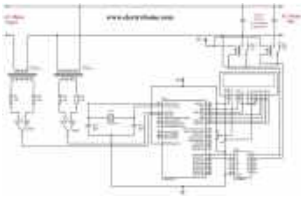

[Temperature and relative humidity display with adaptive brightness control](#) The objective of this project is to illustrate a technique of implementing adaptive brightness control to Smart TrH Display and seven segment LED displays. It consists of a closed loop system that continuously assesses ambient light condition using an inexpensive light-dependent resistor (LDR) and uses..... Listed under: [Temperature Measurement Projects](#)

1643.  [LED Infinity Mirror Controller, 32 LEDs, Multiple Patterns using PIC12F675](#) LED Infinity Mirror Controller, 32 LEDs, Multiple Patterns UPDATE: This kit is discontinued please see the new version, 8 Channel LED Controller v.3, the development files are still available to build this version. As simple a circuit as can be. A 12F675 controls a high-power shift register,..... Listed under: [LED Projects](#), [Projects](#)
1644.  [Interfacing of PIC12F675 with \(i2c based\) 24LC64 EEPROM \(code + Proteus simulation\)](#) This post provides the code for interfacing 24LC64 EEPROM with PIC12F675 microcontroller. This 24LC64 EEPROM has i2c based interface and PIC12F675 doesn't have any built in i2c modules, so software i2c module is created in the code. This code is written in C language using MPLAB with HI-TECH C..... Listed under: [Interfacing\(USB - RS232 - I2c -ISP\) Projects](#), [Memory - Storage Projects](#), [Projects](#)
1645.  [Making a simple clap switch](#) A clap switch is a fun project for beginners. It switches on and off electrical appliances with a sound of clapping hands. Today we will discuss about making a simple clap switch that operates when it detects two clapping sounds in a row. It uses..... Listed under: [Other Projects](#)
1646.  [2 Digit Counter using PIC12F629 Microcontroller](#) This article describes a 2-Digit Counter using a Microchip PIC12F629. It shows what can be done with an 8-pin chip having just 5 output lines and one input line. The chip drives two 7-segment displays and this would normally require 7 lines to drive the segments..... Listed under: [Clock and Timer Projects](#)
1647.  [Running LED dice](#) Tons of LED dice projects with different output forms have been published online. The most common output configuration in those projects is a 3-1-3 setup (two rows of three LEDs and one LED at in the middle) of seven LEDs, which simulates the actual patterns..... Listed under: [LED Projects](#)
1648.  [PIC USB HID \(Human Interface Device\) Interfacing](#) For long time, UART is the only and best way to interface with PC. It is easy to adapt and handle. Though some devices (like: GSM modem etc.) have UART on themselves, but for interfacing with PC, there is only one thing now and that..... Listed under: [Interfacing\(USB - RS232 - I2c -ISP\) Projects](#)
1649.  [Line follower robot using microcontroller](#) A line following robot is a versatile machine utilized to detect and take after the dark lines that are drawn on the white surface. As this robot is produced utilizing a breadboard, it will be exceptionally easy to build. This system can be fused into..... Listed under: [Robotics - Automation Projects](#)
1650.  [Automatic Power Factor Controller using Microcontroller](#) The thirst for new sources of energy is unquenchable, but we seldom realize that we are wasting a part of the electrical energy every day due to the lagging power factor in the inductive loads we use. Hence there is an urgent need to avoid..... Listed under: [power - energy projects](#)
1651.  [8049 Spy using pic microcontroller](#) What do you do when you have to read the internal ROM contents of a 8048 or 8049 processor and you don't own a programmer for those devices? You simply build this 8049 spy of course! That is exactly what I did when I wanted..... Listed under: [Microcontroller Programmer Projects](#)
1652.  [Understanding the Role and Function of Relays in Electrical Circuits](#) A relay is an electromagnetic switch which is used to switch High Voltage/Current using Low power circuits. Relay isolates low power circuits from high power circuits. It is activated by energizing a coil wounded on a soft iron core. The Role and Function of Relays..... Listed under: [Other Projects](#)
1653.  [Breadboard using dsPIC30F2012 microcontroller](#) Bernard introduces us to the dsPIC microcontroller. He shows us his Arduino like project board for a dsPIC and gives advice on software development tools. This article was submitted by Bernard Klinc as part of the "Hobby parts for articles" program. Bernard received a graphic..... Listed under: [Development Board - Kits Projects](#), [Projects](#)
1654.  [How to use PIC18F4550 as a SPI Slave Transmitter](#) The Serial Peripheral Interface (SPI) is a high speed, synchronous, serial communication standard. This communication protocol is basically a Master Slave implementation where the master device controls the clock based on which the slave devices operates. The master can communicate with one or more slave in..... Listed under: [Interfacing\(USB - RS232 - I2c -ISP\) Projects](#)
1655. [Low Cost Solar Lighting Controller](#) Solar Lighting Controller based on PIC12F675 micro controller to be used with a Solar Panel, Battery and a LED 12V Light, it has built with affordable materials and its ready to use, just plug your devices and its done, this controller will function by





itself..... Listed under: [LED Projects](#)

1656.



[28 Pin PIC Terminal Development Board](#) Replacement: None. We do not have a direct replacement for this board. This page is for reference only. Description: A fun package full of potential projects! Development board for 28 pin PIC microcontrollers with power supply circuit, crystal oscillator circuit, RS232 port, ICSP/ICD port, 16x2..... Listed under: [Development Board - Kits Projects, Projects](#)

1657.



[PIC16F877A-Based Temperature Monitoring System](#) Temperature monitoring and control is important in industry environments. Sensors are widely used for measurement of temperature. Usually, a temperature sensor converts the temperature into an equivalent voltage output. IC LM35 is such a sensor. Here we describe a simple temperature measurement and display system..... Listed under: [Temperature Measurement Projects](#)

1658.

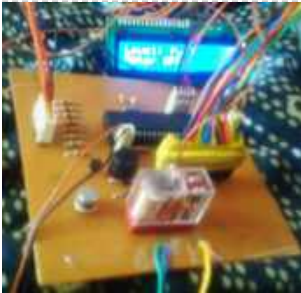

[Water Level Indicator and Controller using PIC Microcontroller](#) Here is a simple, versatile project which indicates the level of water and automatically controls it by using PIC Microcontroller. The Water Level Sensing Section senses the level of water in the tank and sends it (wireless) to the Receiver Section. Receiver Section is connected to the..... Listed under: [Sensor - Transducer - Detector Projects](#)

1659.



[PURPIC, the wearable PICkit2 clone using PIC12F508 programmer](#) PURPIC, the wearable PICkit2 clone PIC programmer based on a design by David Tait using through hole transistors and resistors glued to a piece of cardboard. Oh, how times have changed. And as usual, I'm still 7\* years behind those changed times. My latest project..... Listed under: [Microcontroller Programmer Projects, Projects](#)

1660.

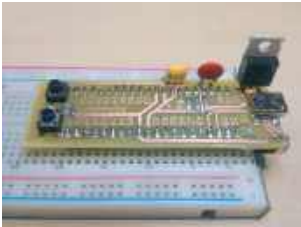

[PICMAN prototyping board using PIC18LF4553](#) For a long time now I've been wanting to make my own microcontroller-based prototyping board. My original motivation was the unjustified high costs for even the simplest boards (a basic Arduino for \$30 - why???) and the challenge of designing something that anyone can make..... Listed under: [Blog, Development Board - Kits Projects, Projects](#)

1661.



[Pic-Plot2 GPIB to USB converter](#) Pic-plot now goes to USB! A perfect low cost solution to quickly get screen plots of your GPIB instrument on your laptop PC without complex software. It emulates the HP7470A operation on the GPIB side, and outputs the HP-GL data at the USB port to..... Listed under: [Interfacing\(USB - RS232 - I2c -ISP\) Projects, Projects](#)

1662.

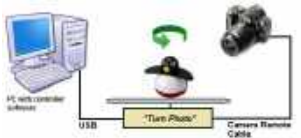

[Turntable Photography Equipment using PIC16F84A](#) A friend asked me if I could build him a device that would allow him to take photos of his products in 360 degrees. That kind of photo is actually an animation that consists of several photos of the same product but from different angles..... Listed under: [Interfacing\(USB - RS232 - I2c -ISP\) Projects, Projects, Video - Camera - Imaging Projects](#)

1663.



[Color Globe using PIC16F688 Microcontroller](#) This was a fun little project I put together in a few hours for a homemade-themed gift exchange this Christmas. I had on-hand a "Full Color LED" from Radio Shack (part 276-0028) which caught my eye on my last visit there. The LED has a..... Listed under: [Game - Entertainment Projects, Home Automation Projects, Projects](#)

1664.



[Using Multiplexed 7 Segment Displays – PIC Microcontroller Tutorial](#) A four digit seven segment display. The image above shows a four digit seven segment display. These type of displays are widely used to present numerical data to users. Example includes clocks, panel meters, microwave ovens, refrigerators etc. As you can see in a four..... Listed under: [LED Projects](#)

1665.









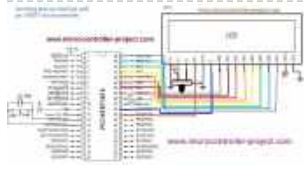

[AT Keyboard Interface V1.04 using PIC16F84](#) Introduction Sometimes you only need a simple and cheap RS232 terminal to get sufficient control over a PC or a RS232 device. There is no need, no space or even no power to place a monitor, a computer case and a keyboard. Maybe there exists..... Listed under: [Interfacing\(USB - RS232 - I2c -ISP\) Projects, Projects](#)

1666.

[PIC Projects: Digital Temperature Controller](#) Digital temperature controller is an essential instrument in the field of electronics, instrumentation and control automation for measuring and controlling temperatures. It can be used as much at homes as in industrial applications. Different types of analogue and digital temperature controllers are readily available in..... Listed under: [Temperature Measurement Projects](#)



1667.  [Joy Stick Controller using PIC12F629](#) This project controls two servo motors - both clockwise and anticlockwise and has variable speed. You can use the Joy Stick to "pan and tilt" a remote camera or provide "left-right-up-down" action for a crane or an animation on your model layout. The project also..... Listed under: [Game - Entertainment Projects, Projects](#)
1668.  [Displaying Scrolling\(Moving\) text on 16x2 lcd Using Pic16f877 and Pic18f452 Microcontroller](#) Displaying moving or scrolling text on lcd(16x2,8x1,16x4,8x2,16x1,20x1,20x2 etc) is very easy. You just need to know how to efficiently use lcd commands. In this project i am using pic 16f877 microcontroller to display text and then scroll it on the lcd. The lcd which i am..... Listed under: [LCD Projects](#)
1669.  [Mars Clock using PIC16F877A microcontroller](#) What do you do if you have a spare LCD module with backlight, a weird 16 button keyboard, and a PIC16F877A microcontroller gathering dust? A monster Martian Clock immediately springs to mind. You are probably thinking "There are hundreds of PIC clocks on the Net..... Listed under: [Clock and Timer Projects](#)
1670.  [LED Christmas Cards using PIC 10F200](#) This is an instructable on how to build an LED Christmas card using the PIC 10F200 microcontroller. As this PIC has six pins and is the size of an SMD transistor, it is ideal for low profile applications and can easily be reprogrammed as and..... Listed under: [LED Projects](#)
1671.  [Interfacing Matrix Keypad with PIC Microcontroller](#) This tutorial explains 'What is a Matrix Keypad ?' and 'How to Interface Matrix Keypad with PIC Microcontroller ?'. Matrix Keypad Matrix Keypad is a very useful and userfriendly when we want to design certain applications like Calculator, Telephone etc. Matrix Keypad is made by arranging push button..... Listed under: [Calculator Projects](#)
1672.  [The simple Joule Thief](#) The Joule Thief is such an easy and simple device, but what it does is amazing. It can use a battery that is not usable in any other electronic device and give it life again. It can even take a battery that won't even power..... Listed under: [LED Projects](#)
1673.  [Interfacing Real Time Clock \(RTC\) DS1307 with PIC Microcontroller](#) DS1307 is a low power serial real time clock with full binary coded decimal (BCD) clock/calendar plus 56 bytes of NV SRAM (Non Volatile Static Random Access Memory). Data and Address are transferred serially through a bidirectional I2C bus. The RTC provides year, month, date, hour, minute and..... Listed under: [Clock and Timer Projects](#)
1674.  [Aurora 48 – 48 RGB LED Sequencer using PIC24FV16KA304](#) Aurora 48 is a compact and thin profile full-color LED sequencer. It's built entirely with surface mount components, so the profile is nice and clean. Features Capable of individually controlling 48 Full color LEDs. Each LED can be faded in 7 bit per channel - 2,097,152..... Listed under: [LED Projects, Projects](#)
1675.  [DC Motor Speed Control using PWM with PIC Microcontroller](#) I already posted about Interfacing DC Motor with PIC Microcontroller. In our robotics applications we may have to control the speed of the DC Motor. In this tutorial we will see how to control the speed of a DC Motor using Pulse Width Modulation (PWM)..... Listed under: [Motor Projects](#)
1676.  [Interfacing Stepper Motor with PIC Microcontroller](#) Introduction A Stepper Motor is a brushless, synchronous DC electric motor, which divides the full rotation into a number of equal steps. It finds great application in field of microcontrollers such as robotics. Please refer the article Stepper Motor or Step Motor for detailed information about working..... Listed under: [Motor Projects](#)
1677. [Voltmeter and Ammeter using PIC Microcontroller](#) Voltmeter and Ammeter can be easily made using PIC Microcontroller having ADC (Analog to Digital Converter). I am using PIC16F877A and the result is displayed on an LCD Display. PIC16F877A is enough if you do this project only for testing purposes. I suggest to use..... Listed under: [Metering - Instrument Projects](#)





1678.



[HandySwipe portable magnetic card reader using PIC16F688](#) The HandySwipe provides a portable magnetic card reader interface and display. It collects card data from a "Type 2" card reader (shown here), and displays the data on a small character LCD screen. Type 2 stripes are by far the most common in use, such..... Listed under: [Interfacing\(USB - RS232 - I2c -ISP\) Projects, Projects, Sensor - Transducer - Detector Projects](#)

1679.



[Interfacing LCD with PIC Microcontroller – MPLAB XC8](#) In this tutorial we will see How to Interface a 16×2 character LCD module with PIC 16F877A Microcontroller using MPLAB X IDE and MPLAB XC8 C Compiler. 16×2 Character LCD is a very basic and low cost LCD module which is commonly used in electronic..... Listed under: [LCD Projects](#)

1680.



[LED message system on a Strida folding bicycle wheel using PIC12F675](#) LED message system on a Strida folding bicycle wheel After I've bought my strida folding bicycle, one of the first things I've done was to check out instructables.com for any strida related projects. And quite astonished to see that there wasn't any. So I've planned..... Listed under: [Game - Entertainment Projects, LED Projects, Projects](#)

1681.



[Schematic PIC Data Logger with Delta-Sigma Converter](#) Labels: circuit >> data logger >> MICROCONTROLLER >> PIC >> Project >> schematic The aim of the project is to build a lab-grade data logger with PIC18F45K20 microcontroller and a 20-bit delta-sigma converter. It's named as G5 Data Logger. This new data converter technology using..... Listed under: [Other Projects](#)

1682.



[Interfacing LCD with PIC Microcontroller – Hi Tech C](#) 16×2 Character LCD is a very basic LCD module which is commonly used in electronics projects and products. It contains 2 rows that can display 16 characters. Each character is displayed using 5×8 or 5×10 dot matrix. It can be easily interfaced with a microcontroller..... Listed under: [LCD Projects](#)

1683.

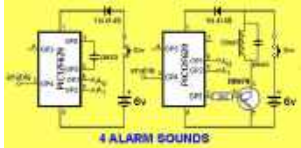

[4 ALARM SOUNDS using PIC12F629](#) This project is a miniature 1-chip alarm. All you need is a tilt switch, battery and piezo to produce a complete alarm. If you want a very high output, you can add a Darlington buffer transistor, piezo tweeter and a 10mH choke. The chip does..... Listed under: [Projects, Security - Safety Projects](#)

1684.



[Custom Characters on LCD using PIC – MPLAB XC8](#) I hope that you already go through our tutorial, Interfacing LCD with PIC Microcontroller – MPLAB XC8. HD44780 compatible controllers used in these LCDs allows us to define 8 custom characters in addition to the standard pre-programmed characters. In this tutorial we will learn, how..... Listed under: [LCD Projects](#)

1685.



[Single Chip Temperature Data Logger](#) Introduction A data logger is a device that records measurements over time. The measurements could be any physical variable like temperature, pressure, voltage, humidity, etc. This project describes how to build a mini logger that records surrounding temperature values. It has following features: - Uses..... Listed under: [Temperature Measurement Projects](#)

1686.















[Interfacing Servo Motor with PIC Microcontroller – MPLAB XC8](#) Servo Motor is an ordinary geared dc motor equipped with closed loop servo mechanism which uses position feedback to control exact angular position of the rotor. These are commonly used in robotic arms, legs etc. Servo Motors do not rotate continuously, their rotation is limited..... Listed under: [Motor Projects](#)

1687.



[Using Push Button Switch – MPLAB XC8](#) I hope that you already go through the first tutorial of MPLAB XC8, Getting Started with MPLAB XC8 – LED Blinking. In that tutorial we learn how to use an output pin by driving an LED. In this we will learn how to read an..... Listed under: [LED Projects](#)

1688.  [LED Strobe for PIC12F629](#) Description This project functions as a simple strobe for driving an LED. The use of an output transistor allows it to pulse the strobe LED with a current up to 100mA. Four jumpers provide options for changing the pulse width, strobe repeat interval and single..... Listed under: [LED Projects](#), [Projects](#)
- 
1689.  [Digital Thermometer using PIC Microcontroller and LM35 Temperature Sensor](#) Thermometer can be easily constructed using a PIC Microcontroller and LM35 Temperature Sensor. LM35 series is a low cost and precision Integrated Circuit Temperature Sensor whose output voltage is proportional to Centigrade temperature scale. Thus LM35 has an advantage over other temperature sensors calibrated in Kelvin as the..... Listed under: [Sensor - Transducer - Detector Projects](#)
- 
1690.  [Programmable relay switch using PIC MCU \(revised version\)](#) Programmable relays are key elements in numerous automation applications such as automatic street light control, watering and pump control, HVAC, home automation, power plants automation in industries, etc. This article describes a DIY programmable relay switch using PIC16F1847 (PIC16F628A can also be used) microcontroller. It is a..... Listed under: [Clock and Timer Projects](#)
- 
1691.  [PICs in Space](#) Features Full colour Animated invaders High-resolution display High-quality stereo sound effects Non-volatile high score table High-tech rolling score Mother ship with random score Progressively increasing speed and difficulty Realistic shield damage Bonus lives Compatible with 625-line/50Hz televisions that have an RGB SCART input Uses standard..... Listed under: [Video - Camera - Imaging Projects](#)
- 
1692.  [Using Easy Pulse mikro with MPLAB Xpress board](#) Easy Pulse mikro is our new educational pulse sensor in a mikroBus form factor. Like our previous Easy Pulse sensors (Easy Pulse and Easy Pulse Plugin), it is also based on the principle of transmittance photoplethysmography (PPG) applied to a fingertip. The sensor consists of..... Listed under: [chipKIT Projects](#), [Sensor - Transducer - Detector Projects](#)
- 
1693.  [RDS/RBDS decoder with optional FM stereo receiver using PIC18F452](#) This project supports both RDS (Europe) and RBDS (USA) Tuner FM band 88..108 MhZ (Europe and USA.) You can choose between a 4x20 character LCD or a smaller graphical LCD to display data. A simple RS232 interface can also be used. A 4x20 character LCD..... Listed under: [Projects](#), [Radio Projects](#)
- 
1694.  [Infra-Red Transmitter using PIC12F675 microcontroller](#) Description This project uses a MicrochipPIC microcontroller and an Infra-Red LED to act as a PC controlled cable TV changer. Operation The purpose of this is so that my MythTVPersonal Video Recorder (PVR) can change channels on the cable TV set-top box when making a..... Listed under: [Internet - Ethernet - LAN Projects](#), [Projects](#), [Radio Projects](#)
- 
1695.  [Writing Your First Program with PIC Microcontroller and Setting up Configuration Bits](#) This is the second tutorial of our PIC Tutorial Series. In our previous tutorial Getting started with PIC Microcontroller: Introduction to PIC and MPLABX, we learnt the basic stuff about our PIC microcontroller, we also installed the required software and purchased a new PicKit 3..... Listed under: [LED Projects](#)
- 
1696.  [An LED Persistence Of Vision Name Badge using PIC16F88](#) An LED Persistence Of Vision Name Badge This Instructable shows a name badge that I have built for my daughter. I have seen the Defcon badges, and thought they were cool. Why cant my kids have one as well - but specially built for them?..... Listed under: [LED Projects](#), [Projects](#)
- 
1697.  [LED Blinking with PIC Microcontroller](#) In our previous two tutorials we discussed How to Get Started with PIC using MPLABX and XC8 compiler, we have also made our First LED Blinking Program with PIC and verified it by simulation. Now it's time for us to get our hands on to..... Listed under: [LED Projects](#)
- 
1698.  [LED Blinking Sequence using PIC Microcontroller](#) In our previous tutorial, we learnt about Blinking a LED using PIC microcontroller and built the same circuit on Perf board. Then we used PICkit 3, ICSP and MPLAB IPE for dumping the program onto our Perf board. Now, in this tutorial we will advance..... Listed under: [LED Projects](#)
- 
1699.  [Understanding Timers in PIC Microcontroller with LED Blinking Sequence](#) This will be the fifth tutorial in our PIC Tutorial Series, which will help you to learn and use Timers in PIC16F877A. In our previous tutorials, we had started with Introduction to PIC and MPLABX IDE, then we wrote our first PIC program to blink..... Listed under: [Clock and Timer Projects](#)
- 
1700. [PIC Based Car Battery Voltage Monitoring System](#) In this project we are going to make a PIC based Car Battery Monitoring system on PCB. Here we have designed a PCB using EASYEDA online PCB simulator and designer. This Car Battery Monitoring Circuit is used to monitor the power of Car Battery by..... Listed under: [Car Projects](#)



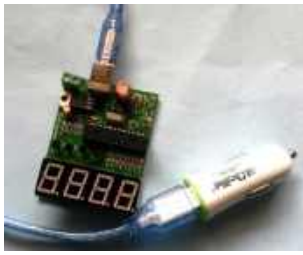

1701.

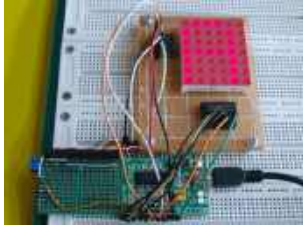

[Basics of LED dot matrix display. Part 1. Theory using pic microcontoller](#) LED dot matrices are very popular means of displaying information as it allows both static and animated text and images. Perhaps, you have encountered them at gas stations displaying the gas prices, or in the public places and alongside highways, displaying advertisements on large dot..... Listed under: [LED Projects](#)

1702.



[LCD Interfacing with PIC Microcontroller using MPLABX and XC8](#) This is our sixth tutorial in our PIC Tutorial Series, in this tutorial we learn Interfacing of 16x2 LCD with PIC Microcontroller. In our previous tutorials we have learnt the basics of PIC using some LED blinking Programs and have also learnt How to use Timers..... Listed under: [LCD Projects](#)

1703.



[PIC16F88 Delorme Tripmate GPS Logger](#) This project focused on creating a simple serial data logger for the Delorme Tripmate (also known as the GPSTripmate). The Tripmate is an older GPS receiver that can be purchased on eBay for <\$20. I happen to have one that my family used a couple..... Listed under: [GPS Based Projects, Projects](#)

1704.



[Dspic-Servo Project using PIC30F4012 microcontroller](#) Project Description This project was developed as an inexpensive way to drive small dc brushed motors as positioning servos for use on a desktop sized CNC machine. The board is interfaced to the PC through 2 pins of a parallel port. The drive signal on..... Listed under: [Other Projects, Projects](#)

1705.



[Display Custom Characters on 16x2 LCD using PIC Microcontroller and XC8](#) In our previous tutorial, we have learnt How to Interface a 16\*2 LCD with PIC Microcontroller. We recommend you to go through it before going any further, if you are beginner in PIC microcontroller. Previously we have also learnt the basics of PIC using LED blinking..... Listed under: [LCD Projects](#)

1706.



[LCD interface with Microcontroller PIC: Beginner's guide using pic microcontoller](#) How to interface LCD (Liquid Crystal Display) display module to PIC microcontroller? LCD is a passive component, that is it does not make any light but just modifies the light passing through it for alphanumeric displays. LCD is exclusively manufactured to be used with microcontrollers,..... Listed under: [Interfacing\(USB - RS232 - I2c -ISP\) Projects, LCD Projects](#)

1707.



[7 Segment Display Interfacing with PIC Microcontroller](#) This is our 8th tutorial of Learning PIC microcontrollers using MPLAB and XC8. We have come up all the way from installing MPLABX to using a LCD with PIC MCU. If you are new here, then look at previous tutorials where you can learn timers,..... Listed under: [LCD Projects](#)

1708.

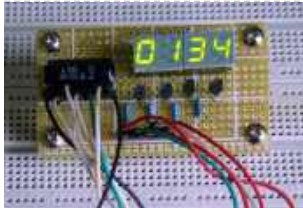

[LabVIEW motion controller using pic microcontroller](#) In Lab 6, we discussed about interfacing a seven segment LED display to a PIC microcontroller. The seven segments were driven individually through separate I/O pins of the microcontroller. If we do just like that then for 4 seven segment LED displays, 28 I/O pins..... Listed under: [LED Projects](#)

1709.



[Using ADC Module of PIC Microcontroller with MPLAB and XC8](#) This is our 9th tutorial of Learning PIC microcontrollers using MPLAB and XC8. Till now, we have covered many basic tutorial like getting started with MPLABX, LED blinking with PIC, Timers in PIC, interfacing LCD, interfacing 7-segment etc. If you are an absolute beginner, then please..... Listed under: [LED Projects](#)

1710.



[DIY Microcontroller – Hand Dynamometer](#) Did this DIY Hand Dynamometer as a sensor for PICAXE micro-controller. It also can be use for Arduino or any micro-controller too. List of the materials I used to make Hand Dynamometer : 1) Hand Exerciser from Amazon - 1 pc 2) Flex Sensor 2.2"..... Listed under: [How To - DIY - Projects](#)

1711.

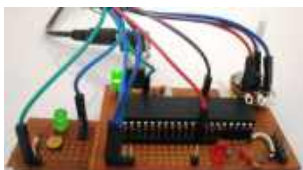







[Generating PWM using PIC Microcontroller with MPLAB and XC8](#) This is our 10th tutorial of Learning PIC microcontrollers using MPLAB and XC8. Till now, we have covered many basic tutorials like LED blinking with PIC, Timers in PIC, interfacing LCD, interfacing 7-segment, ADC using PIC etc. If you are an absolute beginner, then please visit the complete list of PIC tutorials..... Listed under: [PWM Projects](#)

1712.

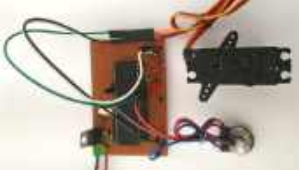

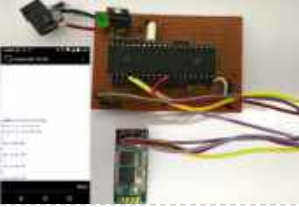
[GPS REPEATER/SYSTEMS MONITOR using PIC16F876](#) Introduction This circuit is a repeater for GPS data. It is intended to connect to Garmin-38 (and similar) hand held GPS receivers that don't have external antennas. The purpose for

the repeater is to allow the GPS to be outside, exposed to the satellite view,..... Listed under: [GPS Based Projects](#), [Projects](#)

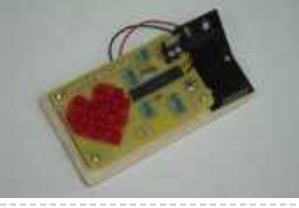
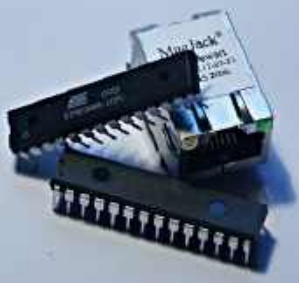
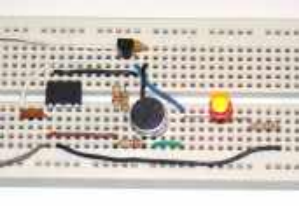
1713.  [Interfacing Servo Motor with PIC Microcontroller using MPLAB and XC8](#) This is our 11th tutorial of Learning PIC microcontrollers using MPLAB and XC8. In this tutorial we will learn How to control Servo Motor with PIC Microcontroller. If you have already worked with Servo motors you can skip the first half of this tutorial but..... Listed under: [Motor Projects](#)
1714.  [UART Communication using PIC Microcontroller](#) In this tutorial we learn to Enable UART communication with PIC Microcontroller and how to transfer data to and from your Computer. So far, we have covered all basic modules like ADC, Timers, PWM and also have learnt how to interface LCDs and 7-Segment displays. .... Listed under: [Other Projects](#)
1715.  [50 MHz frequency counter, voltage meter & SWR/PWR indicator using PIC16C71](#) Circuit schematic PCB HEX code, V1.11 (operates with 4,000 MHz quartz) Hex code, V1.12 (operates with 4,1943 MHz quartz) PIC config bits Photo - Top view Photo - Bottom view Photo - Latest PCB version with TO-92 style 78L05 housing - Top view (132..... Listed under: [Interfacing\(USB - RS232 - I2c -ISP\) Projects](#), [Metering - Instrument Projects](#), [Projects](#)
1716.  [Interfacing Bluetooth Module HC-06 with PIC Microcontroller](#) In this tutorial we will learn How to make out PIC projects wireless by interfacing a Bluetooth Module (HC-06). In our previous tutorial we have already learnt How to use USART module in our PIC Microcontroller and established communication between PIC and Computer. If you..... Listed under: [Other Projects](#)
1717.  [Humidity and temperature measurements with Sensirion's SHT1x/SHT7x sensors using PIC18F2550 \(Part 2\)](#) In Part 1 of this tutorial, we discussed about Sensirion's SHT1x and SHT7x series of humidity sensors, their interface specifications, the communication protocol used for transferring data in and out of the sensor, and the equations to convert their digital outputs to actual physical quantities..... Listed under: [Projects](#), [Sensor - Transducer - Detector Projects](#), [Temperature Measurement Projects](#)
1718.  [Tiny PIC bootloader using PIC16F microcontroller](#) Tiny Bootloader This is a bootloader for the Microchip PIC microcontrollers. It is the smallest bootloader, taking less than 100 words of program space; Supports families of PIC devices: 16F, 18F, dsPIC30 (those devices that support self-programming) Does not support yet PIC24, dsPIC33, PIC18xxJyy Download..... Listed under: [Projects](#), [RTOS - OS Projects](#)
1719.  [DIY Digital Clock with Temperature Display using PIC Controller](#) One of the most enjoyable part of being an electronics person is creating your own gadgets and using them in daily life. In this article, we are building one of those with the help of SoloPCB design tools, a digital desk clock with temperature display..... Listed under: [Clock and Timer Projects](#)
1720.  [motor controller for R/C models](#) Technical specification Supply voltage: 6 to 10 V Supply current: <5 mA Max. output current: 40 A Processor: PIC16C84 Connection: 3-pin plug Application: model boat, car, plane Versions: unidirectional or bidirectional Motor brake: internal with unidirectional version Thermal protection: at 120°C Radio-controlled (R/C) modelling seems..... Listed under: [Motor Projects](#)
1721.  [LED Heart PWM Fading using PIC18F252](#) With my Grandma's birthday fast approaching I wanted to put something together that was not too complicated but still sweet enough to make for a cool widget gift. Since fading LEDs never seem to go out of style and grandmas always love to see a..... Listed under: [Game - Entertainment Projects](#), [LED Projects](#), [Projects](#), [PWM Projects](#)
1722.  [An AVR microcontroller based Ethernet device](#) Ethernet has traditionally been a quite complex interface. All Ethernet chips until today had 100 pins or more, where difficult to find in small quantities and difficult to use from a small microcontroller with little memory. Microchip has changed the world with their new ENC28J60..... Listed under: [Internet - Ethernet - LAN Projects](#)
1723.  [Making a simple clap switch using PIC12F683](#) A clap switch is a fun project for beginners. It switches on and off electrical appliances with a sound of clapping hands. Today we will discuss about making a simple clap switch that operates when it detects two clapping sounds in a row. It uses..... Listed under: [Metering - Instrument Projects](#), [Projects](#)
1724. [Simple Power Guard – PIC12F683](#) This is a very simple and accurate power guard circuit. This circuit is useful to guard the electronic or electrical devices from mains transients and spikes. Very high spikes can develop at power on due to sparking in the switch and more serious effects occur..... Listed under: [Metering - Instrument Projects](#)





1725. [TD-USB-01 interface with mouse sensor board using PIC18F2550](#) This is an example USB project showing how to interface an optical mouse sensor (the ADNS-2620) with a standard XP/Vista computer. The TD-USB-01 board with a PIC18F2550 communicates with: the PC: USB 2.0 through a mini-B connector. the mouse sensor board: SPI over 4-wire flatcable..... Listed under: [Interfacing\(USB - RS232 - I2c -ISP\) Projects](#), [Projects](#), [Sensor - Transducer - Detector Projects](#)



1726. [IR On/Off Switch Using Microcontroller](#) Turn ON or OFF electrical devices using remote control is not a new idea and you can find so many different devices doing that very well. For realization of this type of device, you must make a receiver, a transmitter and understand their way of..... Listed under: [Home Automation Projects](#)



1727. [Mädchen Machen Technik](#) The "Mädchen Machen Technik" workshop is designed to give high school students an introduction to microcontrollers. The students will build a flashing light pattern and/or a counter-timer. In the process of building this project, the students will learn about microcontrollers and digital electronics. Here is..... Listed under: [Other Projects](#)



1728. [8051-PIC MICROCONTROLLER PROJECTS](#) USB AVR In-System-Programmer (ISP) - The AVR firmware was written by: Klaus Leidinger - The PCB was designed by: Dimitris Porlidas - The schematic diagram was drawn by: Dimitris Porlidas - The AvrOspII software was written by: Mike Henning - Small modifications in firmware and..... Listed under: [Microcontroller Programmer Projects](#)



1729. [Leon's Mini Random Number Generator](#) Sales Pitch Are you confused by choices? Who isn't? There are just so many things to decide. White, rye, or wheat? Pinstripes or polka dots? Feast or fast? Well, don't worry because help is on the way! I'm introducing the world's first, portable, hand held,..... Listed under: [Calculator Projects](#)



1730. [The Magnetometer using PIC16F688](#) I found several different magnetometer designs on Internet, but I tend to be very picky. None of those was what I needed - something that is sensitive enough to record the small magnetic field variations where I live (San Jose, California), robust enough to work..... Listed under: [Metering - Instrument Projects](#), [Projects](#)



1731. [PIC based Oscilloscope](#) I have seen many examples of microcontroller oscilloscopes on the web and have had an itch to build one myself. In order to accomplish this my initial thought is to sample an input (ADC) at constant time increments and then display the waveform on a..... Listed under: [Other Projects](#)



1732. [Digital clock ds1307 using PIC microcontroller](#) Step 1: COMPONENTS REQUIRED 6 components needed : 1. Microcontroller (I have used AT89S52-8051 family), any programmable microcontroller can be used. 2.7 segment display 3.Crystal oscillator (12MHz) 4.Capacitor (10uF, 33pF/22pF) 5.LEDs 6.resistances (330 Ohm) 7.buzzer (piezo) 8.push switches And I'm not including soldering iron, wire, flux..... electricity !!!..... Listed under: [Clock and Timer Projects](#)



1733. [pic-microcontroller](#) Home Alarm System PIC16F84A Alarm Clock Analog data recording and playback unit Animated LED Signboard Capacitance measurement Capacitor meter Christmas Light Flasher Microcontroller PIC16F877A is one of the PICMicro Family microcontroller



which is popular at this moment, start from beginner until all professionals. Because very..... Listed under:

[Microcontroller Programmer Projects](#)

1734.

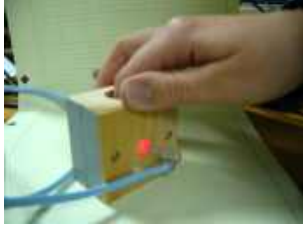

[MEASURING HEART RATE USING A PHOTOPLETHYSMOGRAPHIC CARDIOTACHOMETER](#) ABSTRACT The heart rate is an important measure of health and physical fitness. Medical professionals rely heavily on the rate as a measure of health status and use it to prescribe treatment to individuals. Athletes value the heart rate highly as a tool for regulating..... Listed under: [Medical - Health based Projects](#)

1735.



[Roll and Temperature sensor applications using PIC18F2550](#) This page will show you how to use the TD-CMP modules in a way which fits you most. Here are the technical specifications of the modules: Compass: Resolution: 1° - Accuracy: 3° Tilt/Roll: (TD-CMP02 and TD-CMP03 only) Resolution: 2° - Accuracy: 5° Temperature: (TD-CMP03..... Listed under: [Projects](#), [Sensor - Transducer - Detector Projects](#), [Temperature Measurement Projects](#)

1736.



[An Introduction to Brushless DC Motor Control](#) The brushless DC (BLDC) motor is becoming increasingly popular in sectors such as automotive (particularly electric vehicles (EV)), HVAC, white goods and industrial because it does away with the mechanical commutator used in traditional motors, replacing it with an electronic device that improves the reliability..... Listed under: [Motor Projects](#)

1737.



[PIC-Programmer 2 for PIC16C84 etc.](#) This Programmer is powered by the RS-232 and it works with RS-232 levels at only  $\pm 8.6V$ . It programs PIC12C5XX, 12C67X, 24CXX, 16C55X, 16C61, 16C62X, 16C71, 16C71X, 16C8X, 16F8X and ISO-CARD's with ASF. Other serial programmable chips by adapter. The high Vpp is obtained by..... Listed under: [Development Board - Kits Projects](#)

1738.



[THE SIMPLE ROVERBOT](#) Construction Concepts and Goals Construct a vehicle powered only by a standard 9 Volt battery that can avoid obstacles on the left and on the right. The vehicles will have two buttons mounted on the front (left and right). For example, if the vehicle hits..... Listed under: [Robotics - Automation Projects](#)

1739.

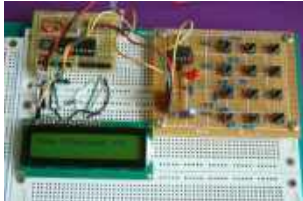

[2-Wire Keypad Interface Using a 555 Timer using PIC16F628A](#) Keypads are a very commonly used input device in microcontroller-based systems. In a keypad, multiple switches are arranged in rows and columns so that they could be interfaced to a microcontroller with a minimum number of I/O pins. For example, a 12-key keypad is arranged..... Listed under: [Interfacing\(USB - RS232 - I2c -ISP\) Projects](#), [Projects](#)

1740.

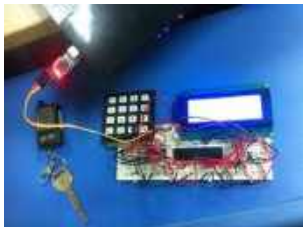

[Matrix Keypad interfacing with PIC microcontroller.](#) Matrix keypads are very useful when designing certain systems which needs user input. These keypads are constructed by arranging push button switches in rows and columns as shown in Fig.1. Scanning keypad to detect pressed keys involves several steps and there are several methods to..... Listed under: [Interfacing\(USB - RS232 - I2c -ISP\) Projects](#)

1741.



[Spooky Led Lamp using PIC12F675 microcontroller](#) Spooky Led Lamp This is a hollowed out light bulb filled with fluorescent liquid and two UV leds plus one red led immersed in the liquid. When turned on the light bulb flickers for a while then starts to pulsate randomly with the UV leds..... Listed under: [LED Projects](#), [Projects](#)

1742.

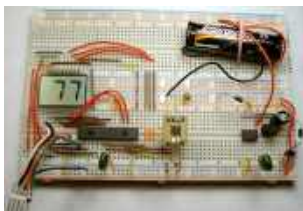

[Driving LCD directly from PIC](#) This project is one another thermometer application that uses the TCN75A digital sensor from Microchip. The sensor provides digital temp conversion in the range  $-40^{\circ}C - 125^{\circ}C$  ( $-40^{\circ}F - 257^{\circ}F$ ) and has maximum resolution  $0.0625^{\circ}C$ . However, the LCD that I used (2.5 digits model LCD-S2X1C50TR..... Listed under: [LCD Projects](#)

1743.





[Wireless PICAXE-based water tank level sensor](#) Over the last few months I have prototyped and built a water tank level sensor for my 9000L rain water tank. The design is based entirely on Silicon Chip's PIC-Based Water-Tank Level Meter, but instead of programming PICs, I prototyped using an arduino, and built..... Listed under: [Sensor - Transducer - Detector Projects](#), [Wireless Projects](#)

1744. [Electrical Subsystem](#) The goal of the electrical design was to streamline an automatic shift control while keeping manual user input in a fast, user-friendly way, incorporating Advanced Electrical Subsystem Control. The electrical design was driven by the complexity required by the mechanical system. The system takes in..... Listed under: [Other Projects](#)







1745.  [pic18f2550 Microcontroller Project Board](#) The new PIC18F2550 Project Board was designed as the development platform for student projects. The board features MCU: PIC18F2550 with external xtal, ADC: one channel 0-2.5V sigma-delta converter, Linear Technology LTC2400/LTC2420, 6-channel 10-bit ADC 0-5V, Display: Two connectors for text LCD or GLCD, USB: onchip..... Listed under: [LCD Projects](#)

1746.  [Worlds Most Useless Machine Rebuild](#) The Original Build Back in 2009 I build my first copy of a "worlds most useless machine" from a video I found on wimp.com, it is no longer posted, which was a copy of the real original by Claude Shannon called the ultimate machine. The..... Listed under: [Battery Projects](#)

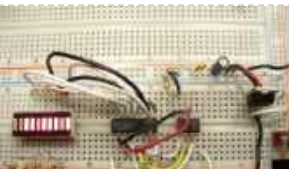
1747.  [Another DIY function generator using PIC16F628](#) An extremely simple and low-cost Sine/Square wave generator, known as the "Custom Function Generator," is developed based on the Analog Devices AD9835 Direct Digital Synthesis (DDS) Generator chip.. The frequency can be set for any frequency from 1Hz to 10MHz in 1Hz resolution steps! All..... Listed under: [How To - DIY - Projects](#)

1748.  [How to use a 74HC595 Shift Register with a AVR ATtiny13](#) Intro: How to use a 74HC595 Shift Register with a AVR ATtiny13 If you have been playing with microcontrollers and electronics then you have likely seen LED dot matrix displays and other projects that use shift registers like 7-segment displays and more. This instructable goes..... Listed under: [Interfacing\(USB - RS232 - I2c -ISP\) Projects, Projects](#)

1749.  [RFM12 – Wireless Transceiver Module Demo using pic microcontoller](#) Description Hardware Software Running the RFM12 Demo Download Links Description This project shows how to do wireless communication with the RFM12 transceiver module in combination with a PIC microcontroller. The RFM12 is a low costing ISM band FSK transceiver module. There are different module variants..... Listed under: [Wireless Projects](#)

1750.  [LED Interfacing with PIC Microcontroller: Embedded C program with circuit using pic microcontoller](#) How to interface LED with Microchip's PIC microcontroller? How to connect LEDs to a PIC microcontroller? LED interfacing is the stepping stone for microcontroller development. This is a simple embedded program for PIC 16F877A to interface LEDs, suitable for beginners who wish to study basics..... Listed under: [Interfacing\(USB - RS232 - I2c -ISP\) Projects, LED Projects](#)

1751.  [Wireless 10 channel receiver using PIC16F630](#) This project can steer 10 different things wireless with the use of a normal TV-remote-control with the RC5 protocol, from manufacturers like Philips, Grundig and Marantz. If the Proton PIC Basic compiler is available, then you can ofcourse change the number of channels. Use it..... Listed under: [Internet - Ethernet - LAN Projects, Projects](#)

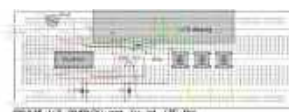
1752.  [DS1820 Temperature regulator using PIC16F628](#) This simple project uses a Dallas DS1820 one wire temperature sensor and a pic 16f628 microprocessor. A simple temperature regulator where a LED symbolizes the Fan. Data derived from the DS18s20 is a 9bit centigrade temperature measurement. As mentioned the temperature sensor communicates over a one Wire..... Listed under: [Interfacing\(USB - RS232 - I2c -ISP\) Projects, Metering - Instrument Projects, Projects, Sensor - Transducer - Detector Projects, Temperature Measurement Projects](#)

1753.  [\\$15.00 BASIC Computer using PIC32MX1 microcontroller](#) \$15.00 BASIC Computer? Imagine a microcontroller that you can connect a serial terminal up to to get an ok prompt? What would happen if you changed one of the control registers can I see the effect straight away? Is it really possible to download programs..... Listed under: [Interfacing\(USB - RS232 - I2c -ISP\) Projects, Other Projects, Projects, RTOS - OS Projects](#)

1754.  [How to Wire a PIC Microcontroller?](#) I'm completely new to the world of PIC Microcontrollers and electrical engineering so please go easy Anyway, I managed to program my PIC 16f627 to turn on three LEDs when push button (trigger button) is pressed and start a shut down sequence (basically each LED..... Listed under: [Microcontroller Programmer Projects](#)

1755. [WEBSD using PIC24F microcontroller](#) WEBSD This is a development board for the PIC24F series of microchip, with: USB ( plug it to any computer) Ethernet ( plug it to the internet) SD card ( save and read all data you will need) I developed this thing as a learning platform,.....

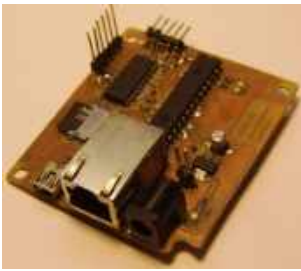

Listed under: [Internet - Ethernet - LAN Projects, Projects](#)

1756.

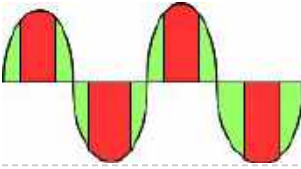

[Control AC load with microcontroller.](#) As per the title of this question i'm trying to control an ac resistive load. So far i had little success and i'm experiencing "strange", to me at least, behaviour from the triac(s) i tried. first of all i post a schematic of my test..... Listed under: [Other Projects](#)

1757.



[PIC12F675 LCD Interfacing Code and Proteus Simulation](#) This post provides the LCD[1] interfacing code using PIC12F675 microcontroller. This code is written in C language using MPLAB with HI-TECH C compiler. You can download this code from the 'Downloads' section at the bottom of this page. It is assumed that you know how to..... Listed under: [Interfacing\(USB - RS232 - I2c -ISP\) Projects, LCD Projects, Projects](#)

1758.



[Versatile SOIC PIC Programming Header using PIC18F88](#) A small PCB allows for the out-of-circuit programming of 18 & 28 pin SOIC PIC Microcontrollers from either an ICSP programmer or ZIF socket. A recent article in a popular electronics magazine presented a small printed circuit board for programming 18-pin SOIC PICs from a..... Listed under: [Microcontroller Programmer Projects, Projects](#)

1759.



[10-minute sewable iPod remote using PIC10F222 microcontroller](#) 10-minute sewable iPod remote There are a lot of really cool iPod remote control projects: some have simple buttons, some react to heartbeat or body motion, and others are designed to interface directly with software running on a computer. However, not one of them is truly..... Listed under: [Other Projects, Projects](#)

1760.

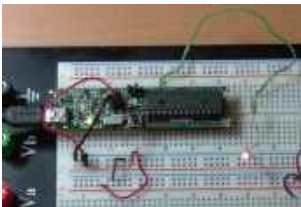

[Execute Open-Source Code in a PIC Microcontroller Using the MPLAB IDE](#) The PIC32 single-board computer is a de facto standard tool for developing microcomputer applications within the hobbyist and educational communities. It provides an open-source hardware (OSH) environment based on a simple microcontroller board, as well as an open-source (OS) development environment for writing software for..... Listed under: [Interfacing\(USB - RS232 - I2c -ISP\) Projects](#)

1761.



[3-Wire Serial LCD using a Shift Register](#) Introduction HD44780 based character LCDs require at least 6 I/O lines from microcontroller to display data. Therefore, they are not suitable for low-pin microcontrollers like PIC12F series microchips. In this project, I am going to show how to drive an HD44780 based LCD display with..... Listed under: [LCD Projects](#)

1762.



[Simple Digital Current Meter \(DCM\) using PIC microcontroller \(Schematic + code + Proteus simulation\)](#) This post would provide a working example of how to make a simple Current Meter (DCM) using 16bit PIC microcontroller and a series shunt resistance. We have very precise ammeter current measurement with a 10bit ADC and with a tolerance of  $\pm 10\text{mA}$ . You may download..... Listed under: [Metering - Instrument Projects](#)

1763.



[Interfacing Ultrasonic Distance Sensor : ASCII Output with PIC Microcontroller](#) In some of our projects, we may want to measure the distance of an object from a point. Ultrasonic Distance Sensors are the best sensor which provides stable, accurate, precise, non-contact distance measurements from 2cm to 4m. Ultrasonic Sensors can be used to measure distance between moving..... Listed under: [Interfacing\(USB - RS232 - I2c -ISP\) Projects](#)

1764.



[j. ICSP Programmer for PIC32 microcontroller family](#) PIC32 ICSP Programmer v1.0 is based on a simple PIC32MX270F256B microcontroller basic circuit. It connects to a PC via USB 2.0 port and therefore needs no external power supply. It may be used to program a PIC32 microcontroller on a circuit via ICSP interface or..... Listed under: [Microcontroller Programmer Projects](#)

1765.



[CITROEN Saxo Vehicle Touch Sensitive switches using PIC16F84A](#) Project Summary The CITROEN Saxo Vehicle Touch Sensitive switches For operating Hazards and two peripheral devices If you want to change the look of your dash board inside a vehicle, maybe just fancy some of modern electronics This could be the design for you Project..... Listed under: [Car Projects, Projects, Sensor - Transducer - Detector Projects](#)

1766.

[PIC16F690 Microcontroller Circuit- How to Drive an LED Display](#) In this article, we will show how to drive a 7 segment LED Display using a PIC16F690 microcontroller. This PIC16F690 microcontroller chip is actually a part of the PIC2 Starter Kit, so we will actually be using this starter kit to drive the LED Display..... Listed under: [LED Projects](#)





1767. [PIC18F452 LED Blinking Code and Proteus Simulation](#) This post provides the LED blinking code (compiled in MPLAB + HI-TECH C) for PIC18F452. Complete project code and the proteus simulation can be downloaded from the Downloads section at the bottom of this post. The following diagram shows the required circuit. In this project a crystal of..... Listed under: [LED Projects](#), [Projects](#)

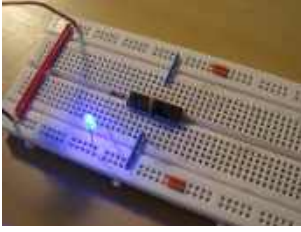

1768. [Ultra-easy use of 64-pin TQFP PIC18F6620 using TQFP-to-DIP PCB from VOTI](#) A while ago I purchased a batch of 18F6620 TQFP PIC Microcontrollers at a ridiculously low price. The barrier to use of TQFP packages is, of course mounting these SMD packages effectively alongside the 'normal' components enthusiasts tend to use. At the time I set..... Listed under: [Development Board - Kits Projects](#), [Projects](#)



1769. [A Minimal USB CDC ACM aka Virtual Serial Port](#) This page introduces a minimal firmware that implements a USB Virtual Serial Port for Microchip PIC18F4550 processor. The code has been optimized to use minimal amount of memory (both Flash and RAM) and tuned to work well with the Free SDCC C-compiler. The code size..... Listed under: [Interfacing\(USB - RS232 - I2c -ISP\) Projects](#)



1770. [pic12f675 Microcontroller 8-PIN PONG](#) This project is based on ideas from Rickard's electronic projects page and David B. Thomas VCR Pong. However, I have developed the simplicity even further, eliminating most of the external components. Using microcontrollers with internal 4MHz clock generator there is no need for the xtal..... Listed under: [Game - Entertainment Projects](#)

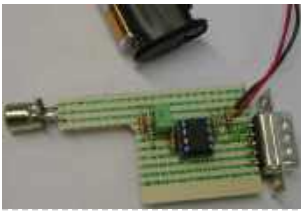

1771. [Using Microcontrollers \( Microchip PIC\)](#) Many people using Arduino or some other development board in their projects, instead of making their own board with microcontroller because they simply don't know how to design PCB with microcontrollers. What microcontrollers need in order to operate? This time I will be focusing on..... Listed under: [Development Board - Kits Projects](#)



1772. [Quick & Easy RGB-LED Tester using PIC16F627 microcontroller](#) Quick & Easy RGB-LED Tester Have you ever built a project with a lot of LEDs, and found out that one of the LEDs was defective? Although it's somewhat rare, there are some defective LEDs when you go through hundreds of them. I found that..... Listed under: [LED Projects](#), [Metering - Instrument Projects](#), [Projects](#)



1773. [MIDI Chord Button Keyboard Using PIC18F4620 part 2](#) How chords are formed Before discussing the processor board and software, it is worth mentioning how the chords are composed. I have provided the table below which shows the installed chords together with the intervals/notes they are constructed from, and examples of each in the..... Listed under: [Projects](#), [Sound - Audio Projects](#)



1774. [Embedded System for Automatic Washing Machine using Microchip PIC18F Series Microcontroller](#) The design uses the PIC18F series microcontroller. All the control functionalities of the system are built around this. Upgradeability is the unique feature of this system. Control card hardware and software allows the manufacturer to add or remove the features as per customer requirement and..... Listed under: [Development Board - Kits Projects](#)



1775. [MIDI Chord Button Keyboard Using PIC18f4620 part 1](#) Every time I sit down to document one of my projects, I try to remember the occasions in the past when looking at the finished web page, I might say 'Well, I won't do that again!', because despite how many drafts I've gone through, there..... Listed under: [Projects](#), [Sound - Audio Projects](#)









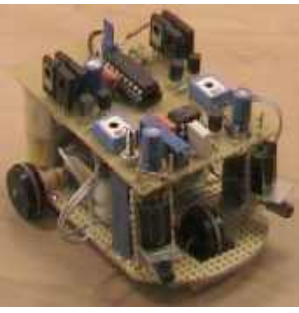
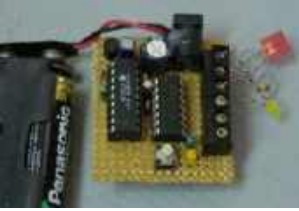
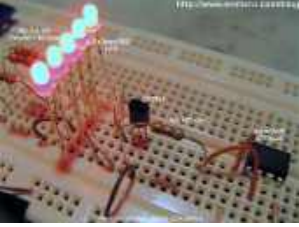

1776. [Isolated RS232C for PIC16F84](#) Another method that helps program development besides a dot LED as the output device is a serial bit. With a serial transmission to a terminal emulator program, developer may then test program running easier than a dot LED. One of my circuit uses PIC16F84 having..... Listed under: [Interfacing\(USB - RS232 - I2c -ISP\) Projects](#), [Projects](#)















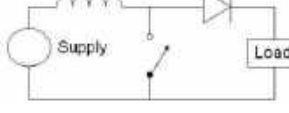

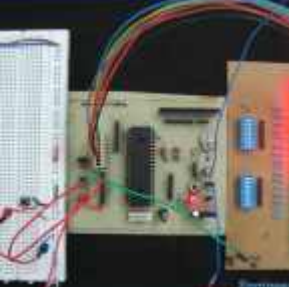
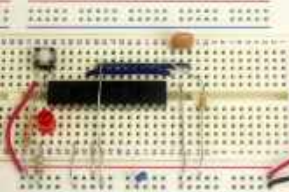



1777. [Bluetooth-Controlled Guitar FX Amplifier](#) As part of our final project for ECE 4760: Digital Systems Design Using Microcontrollers, we built a guitar amplifier with remote distortion and digital effects capabilities controlled from a smartphone via bluetooth. Musicians often need to modify the configuration of their amplifiers when performing in..... Listed under: [Sound - Audio Projects](#)



1778.  [Small 3-wheel ROBOT with PIC16F84 brain & InfraRed eyes.](#) General description erberes is a small three wheel robot that avoids obstacles which it senses with its active infrared sensors. Each rear wheel has its own motor, the single front wheel is not powered. The robot steers "like a tank" by rotating the rear wheels..... Listed under: [LED Projects](#)
- 
1779.  [Miniature Real-Time Controller using PIC16F84](#) Introduction The F84 MRTC was my second design of a miniature real-time controller. This version uses PIC16F84 running with a low power X-tal 32,768Hz. The scheduler for 6-channel output was saved in EEPROM. No terminal for serial downloading of the scheduler. It's suitable for fixed..... Listed under: [Clock and Timer Projects](#)
- 
1780.  [Using Transistor as a Switch](#) Most of microcontrollers work within 5 volt environment and the I/O port can only handle current up to 20mA; therefore if we want to attach the microcontroller's I/O port to different voltage level circuit or to drive devices with more than 20mA; we need to..... Listed under: [Other Projects](#)
- 
1781.  [MultiKey - One Wire Keypad](#) Introduction This is a simple and easy to make serial keypad. The microcontroller will output the number of the push button pressed. This project can be used for many different purposes. Probably the most used application would be to interface to any electronic project that..... Listed under: [Projects](#)
- 
1782.  [Extend PIC Microcontroller's RAM by without using EM](#) Introduction Virtually all PIC microcontrollers have some banking mechanism to extend addressing to additional memory space. But this external data memory is not directly addressable (except in some high versions of PIC18 devices, which include PIC18F8520, PIC18F6620, etc.). In this post we describe easy to..... Listed under: [Memory - Storage Projects](#)
- 
1783.  [100MHz frequency counter with PIC16F628A - LCD Display.](#) This project shows how to build a very simple yet very useful tool that every DIY enthusiast should have in his lab: a 100MHz+ frequency counter. The schematic is fairly simple and straightforward and uses a PIC16F628A microcontroller for measuring frequency and a high speed comparator for..... Listed under: [LCD Projects](#)
- 
1784.  [DTMF Phone Dialer using PIC16F690](#) The company I work for recently upgraded their phone system. They got a new IP phone system that can supposedly do everything - the new phones have big LCD screens with fancy menus, lots of different modes, PC connection for remote control of the phone,..... Listed under: [Phone Projects](#), [Projects](#)
- 
1785.  [Animatronic Robot Head](#) I've improved the old robot head project which can be found at the old articles link.. The head will be powered by servomotors and will be built from sheet plastic, metal or plywood. The template which can be used for cutting sheet material can be..... Listed under: [Robotics - Automation Projects](#)
- 
1786.  [12 DIGIT RUNNING SIGN using PIC16F628](#) It's 1970 and a 12 digit LED Display for pocket calculators has just been released. Nation Semiconductors are in the forefront of designing miniature displays for calculators and have a range from 2-digit to 16-digit displays. The actual 7-segment displays are so small it takes..... Listed under: [Game - Entertainment Projects](#), [LED Projects](#), [Projects](#)
- 
1787.  [100MHz frequency counter with PIC16F628A - LED Display.](#) Couple of weeks ago I purchased from eBay one of these amazingly cheap an useful modules with MAX7219 LED driver and 8 digit LED display. It is ideal for frequency counter project. The problem was the absence of library for PIC microcontrollers. Luckily, I found..... Listed under: [LED Projects](#)
-



1788.  [Mini GSM localizer without GPS using pic microcontoller](#) It's no the first time that we present a localizer without GPS. We remake the old device with the cheaper SimCom module SIM900. In the previous post we present the GSM section and now we can present the complete localizer. Introduction This system allows for..... Listed under: [GPS Based Projects](#)
- 
1789.  [Basic circuit for PIC18F24J50 or PIC18F26J50 to work over USB](#) The basic circuit below will work with any PIC18F2xJ50 microcontroller. You just have to upload the appropriate firmware. Go to Downloads section to find firmware hex files for the microcontroller and the resonator you would like to use. PIC18F24J50 firmware v2.6.3 - all subversions.zip contain..... Listed under: [Internet - Ethernet - LAN Projects](#)
- 
1790.  [Serial LCD Library using PIC16C84](#) Here is a library to interface your PIC code to an LCD that is controlled via a serial line. One such LCD is available from Scott Edwards Electronics. There are many others, and the code shown here can easily be adpated to other LCD displays..... Listed under: [LCD Projects](#), [Projects](#)
- 
1791.  [USB PIC Programmer](#) This page is dedicated to everybody needs to program a PIC (Microchip) device via USB port. Looking on the web for ready-to-use projects, I found a good one called Open Programmer, coming with several schematics, PCBs and Open Source code. The original link is [http://openprog.altervista.org/OP\\_ita.html](http://openprog.altervista.org/OP_ita.html) What concerned..... Listed under: [Interfacing\(USB - RS232 - I2c -ISP\) Projects](#)
- 
1792.  [LCD Serial Terminal using PIC16F84](#) LCD Serial Terminal Introduction: In the 1980s a serial terminal was a big thing with a picture tube and keyboard. You used it to communicate with a computer by RS-232 cable or with a modem. In this century, we still sometimes have need for a..... Listed under: [LCD Projects](#), [Projects](#)
- 
1793.  [Boost converter using IR2110 and pic microcontroller](#) For a recent project, I needed to boost the output from a USB (high ampage charging) port from 5V up to 18V to power an amplified speaker. I decided to try rolling my own boost converter (mainly because playing with big inductors sounded cool). My first attempt..... Listed under: [Interfacing\(USB - RS232 - I2c -ISP\) Projects](#)
- 
1794.  [PIC Stroboscope using PIC12F675 microcontroller](#) PIC Stroboscope You have probably been to a party where there is a strobe and it delays everything. Today we are going to use this principle to "slow" stuff (fans) down. Maybe you have seen one using 555 timers, the Arduino and maybe even the..... Listed under: [Other Projects](#), [Projects](#)
- 
1795.  [18 PIN PIC Development Board](#) The PIC 18 PIN (DIP) Development / Evaluations Board demonstrates the capabilities of Microchip's 8-bit microcontrollers, specifically, 18 Pin PIC16F1847. It can be used as a standalone demonstration board with a programmed part. With this board you can develop and prototype with all Microchip's 18..... Listed under: [Development Board - Kits Projects](#)
- 
1796.  [PIC 18F4550 Timer And Interrupt Example Video Project](#) Welcome back everybody! This video covers multitasking via timers and interrupts with the PIC 18F4550. A few notes on this video: -To keep the pace of the video going I added fast forwarding more than in the previous videos. Please let me know in the..... Listed under: [Clock and Timer Projects](#)
- 
1797.  [An LDmicro Tutorial](#) In this tutorial, I will show you how to write a very simple program. I am assuming that you have written ladder logic before, and that you have some basic familiarity with microcontrollers, but that you have never used LDmicro. If you don't know very..... Listed under: [LED Projects](#)
- 
1798.  [Homemade temperature LED display for PC using PIC16F876](#) Since I started my watercooling prejoect, I have been verry interested in how well it perform, the only way is to measure all temperatures before and after, The motherboard temperature sensors is useless unacurate, so I'm using LM50B By using this LM50B sensor I get..... Listed under: [How To - DIY - Projects](#), [LED Projects](#), [Projects](#), [Temperature Measurement Projects](#)

1799.  [PIC 18F – 28 PIN PIC Development Board](#) Description This is a versatile, configurable, and cost effective Development Board designed for the 18F □ 28 pin series of Microcontroller from Microchip. The board is simplest form with all the Port pins terminating in a header connector for easy connection to the outside world..... Listed under: [Development Board - Kits Projects](#)
- 
1800.  [Heavy duty portable charger for usb devices \(phones, iPad, etc.\) using PIC12F683](#) Heavy duty portable charger for usb devices (phones, iPad, etc.) Ever needed to charge your phone on the go? Can't find a wall socket to charge your iPod? Whenever I'm away from home for an extended period of time, I would charge my phone and mp3..... Listed under: [Battery Projects, Projects](#)
- 
1801.  [FailureBot 5 – A Line Following Robot](#) Introduction The objectives of the FailureBot project originated simply as "build a line-following robot". However, it somehow evolved into a 3-year robotics experiment. My first attempt to build a robot was such a complete failure that I jokingly called it "FailureBot". The name seemed quite..... Listed under: [Robotics - Automation Projects](#)
- 
1802.  [PIC RGB Power Board using PIC12F629 microcontroller](#) Description Power Pic RGB is a circuit that generates random RGB colors using a powerful 3W RGB LED and fades between them. The initial project goal was to develop the fading algorithm which was successfully achieved. This time the idea was to drive a Prolight..... Listed under: [Battery Projects, Projects](#)
- 
1803.  [Open Source 3.2" TFT Smart Display](#) This project is an open source 3.2" Smart TFT display board. The board is based on a PIC32 and a 3.2' TFT with touchscreen (ILI9320 controller, using 16bits PMP). The software has two main parts. One that produces the 2D functions and a GUI with..... Listed under: [LCD Projects](#)
- 
1804.  [PIC'ing the MAX3100: Adding USB to a PIC Microcontroller Using the MAX3100 UART using pic microcontroller](#) Abstract: USB has just become easy to implement. This application note eases equipment designers into USB by allowing them to continue to transmit and receive data using the familiar UART frames of the MAX3100 UART. A UART-to-USB converter IC and operating system driver will take care..... Listed under: [Interfacing\(USB - RS232 - I2c - ISP\) Projects](#)
- 
1805.  [Re-Doing my Design for a circuit to control an invention using a Microchip PIC microcontroller chips.](#) In a previous article I described how I designed the circuitry to control functions of the asparagus harvester. After bread boarding up a test circuit and doing some initial programming I decided a re-do was in order. I found I had a lot of unnecessary..... Listed under: [Development Board - Kits Projects](#)
- 
1806.  [Digital & Binary clock with thermometer & hygrometer](#) Here we have a clock. It's not "another clock". It has digital and binary output. It also has a thermometer and a hygrometer. It's not "another thermo-hygrometer". It display's absolutely humidity (gr/m3) also. Schematic MCU I build it around Microchip PIC16F917, with internal Oscillator..... Listed under: [Clock and Timer Projects](#)
- 
1807.  [USB:- DC Motor Controller using PIC18F4550 \(keyboard\)](#) USB:- DC Motor Controller using PIC18f4550 (keyboard) Hello friends, Requirements USB DEMO interface Board L293D motor controller chip Schematic This a small project on controlling D.C motor with USB pic18f4550 interface board with L293D motor Driver. A small application [C#] is controlling my pic18f4550 USB..... Listed under: [Motor Projects](#)
- 
1808.  [Build your Own PCB Exposure Box with Fluorescent Lamps and Countdown System](#) Introduction Tired of spending hours and hours in wire soldering? Do your circuits look ugly and you are looking for a way to produce professional-like PCBs? Then you had better try photoetching. And the first step to do that is to have the right equipment..... Listed under: [Development Board - Kits Projects](#)
- 
1809. [Use a PIC Microcontroller to Control a Hobby Servo](#) This instructable describes how to integrate hobby servos (the kind used in RC planes, cars, etc.) into your microcontroller projects. Step 1: How Servos are Different from Regular Motors In a regular DC motor, the amount of torque the motor exerts on the shaft is..... Listed under: [Microcontroller Programmer Projects](#)





1810. [Microcontroller Clapper Switch](#) Introduction I always thought the clapper so cool. For those who are lazy like me, turn on or off the bedroom light without getting out of bed, simple clap your hands is amazing. Thinking about it I projected one for me. Several projects of clappers..... Listed under: [Microcontroller Programmer Projects](#)



1811. [Using the MAX6955 LED Display Driver with a PIC Microcontroller to Scroll Messages](#) Abstract: A circuit and program listing for using the MAX6955 LED display driver with a PIC microcontroller and 14-segment displays. The MAX6955 is an LED display driver with an I2C™-compatible, serial interface capable of supporting Fast Mode speeds up to 400kHz. It is capable of driving..... Listed under: [LED Projects](#)



1812. [Ultra low cost solar-rechargeable persistence of vision display using PIC10F206](#) Ultra low cost solar-rechargeable persistence of vision display This device produces a bright and eye catching display to write text and small images through the air. It uses under £2 (approx \$3.20 US at the time of writing) of parts, and is a nice little..... Listed under: [Battery Projects](#), [Projects](#)



1813. [LED UV exposure box](#) Introduction I have been using the toner transfer method for about 9 years with great results. Occasionally I would need a board with finer traces and I would use UV method. My exposure setup allowed only a single sided board to be made and it..... Listed under: [LED Projects](#)



1814. [Smart Button using PIC10F microcontroller](#) Smart Button This is a button a little bit smarter. (Microcontrollers and coffee, who doesn't like) I i'm using it to fill my Coffeemaker with water. This way its a little bit more fun and i always get the same amount of water. Its a simple project,..... Listed under: [Home Automation Projects](#)



1815. [8051 Microcontroller Overview & Hardware – Tutorial #1](#) The intel 8051 series 8bit microcontroller, originally introduced in 1980, remains popular and has had perhaps the longest product life of all such devices. It has become the industry standard for real-time and Boolean control applications. While some (who should know better) have said that..... Listed under: [LED Projects](#)



1816. [OSCCAL Value Finder](#) Introduction When working with microcontrollers that require a factory calibrated oscal value stored in memory, it's very normal that once in a while this setting could be lost during an upload of a new program or when accidentally erasing the device. I'm no exception and..... Listed under: [Projects](#)

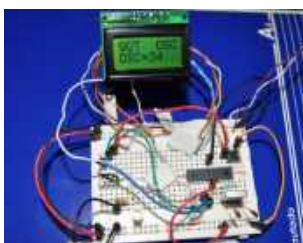

1817. [APPLICATION OF MICROCONTROLLER IN AUTO DETECT DOOR OPEN AND PAPER JAM ERROR using pic microcontoller](#) Microcontroller was invented by Intel sometimes in the 80s ever since that invention other Electronics companies such as Atmel, Microchip and Motorola etc have manufactured different brands of Microcontroller like AT89, PIC16F and 68H All microcontrollers performs specific task based on the set of instructions..... Listed under: [Home Automation Projects](#)

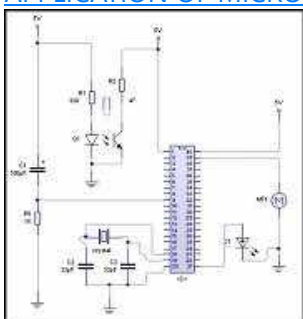

1818. [Interfacing LCD Modules with PIC Microcontrollers.](#) A large number of embedded project require some type of user interface. This includes displaying numerical, textual and graphical data to user. For very simple numerical display we can use 7 segment displays. If the requirement is little more than that, like displaying some alphanumeric..... Listed under: [LCD Projects](#)



1819. [USB Low Pin Kit](#) Introduction USB is very common interface today. If you look around, many of devices today comes with a USB port. Computers, printers, routers, usb keys, etc. All this devices have a USB controller inside. These devices can be divided in two groups: USB Host (like..... Listed under: [Interfacing\(USB - RS232 - I2c -ISP\) Projects](#)



1820. [Solar Recorder using PIC18F458 microcontroller](#) The device used for measuring daily insolation has been developed. The device was built with a PIC18F458 and the 128MB Multimedia Memory Card, MMC. The solar radiation is measured by a calculator solar cell. The PIC chip interfaces the MMC using SPI mode. The interval..... Listed under: [Memory - Storage Projects](#), [Metering - Instrument Projects](#), [Projects](#)



1821. [Interfacing RTC with Microcontroller](#) Have you ever wondered how your PC and phones keep track of time even when the device is turned OFF? Well there is a Real Time Clock (RTC) that is kept powered even is the device is turned OFF. Once the device is turned ON..... Listed under: [Interfacing\(USB - RS232 - I2c -ISP\) Projects](#)



1822. [Details of PIC ICSP and how to use it for pic microcontrollers.](#) PIC ICSP gives you a convenient way of programming PIC Micros without removing the chip from the development or production board. Note: ICSP stands for In Circuit Serial Programming. All you need is a programmer that provides the ICSP connector (usually a six pin molex/dupont..... Listed under: [How To - DIY - Projects](#)

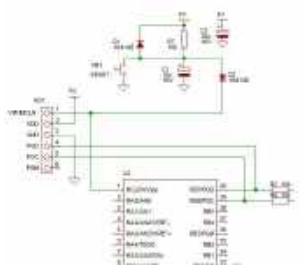

1823. [PicChess](#) This project is a micro controller chess game. The objective has to be able to play chess on a VGA monitor, including an intelligent computer to play against. This all has been accomplished with a microcontroller. I started this as a project for the college..... Listed under: [Game - Entertainment Projects](#), [Microcontroller Programmer Projects](#)



1824. [89Sxx Development Board](#) Introduction There are some 89Sxx development board, here is another one. I have designed this single side development board to be used as a tool for learning MCS-51 Microcontrollers, and for easy microcontroller project development. The 89Sxx development board features : 89Sxx 40-DIL based design,..... Listed under: [Development Board - Kits Projects](#)



1825. [Voltage monitor for car's battery and its charging system PIC16F1827](#) My 2010 Equinox has got every feature that a modern automobile should have. However, one thing that I personally find missing is the real-time monitoring of voltage across the car's battery terminals. This may not seem to be that important but one of the most..... Listed under: [Battery Projects](#), [Car Projects](#), [Metering - Instrument Projects](#), [Projects](#)



1826. [How to generate video signals in real-time using a PIC16F84](#) Background During the Christmas holidays 1997-1998, I started on a small project, trying to generate a video signal with a PIC16C84. I had seen some video clock generating video signals in software, and thought it was a quite interesting idea, and wanted to take it..... Listed under: [Video - Camera - Imaging Projects](#)



1827. [MCU controlled Bluetooth automation with infrared sensor](#) The microcontroller used is 0822 zilog encore! 8k series (soic,28pin) as shown on the figure. Is a programmable microcontroller, the functions used are the GPIO and the UART of the chip. GPIO is used on led indicators, and the UART is used for giving and..... Listed under: [Sensor - Transducer - Detector Projects](#)



1828. [Serial LCDs you can make your own using PIC12F683](#) HD44780 based LCD displays are very popular for embedded projects because they are cheap, easy to interface, can display characters, consume power lot less than seven-segment displays, and most of the present day compilers have in-built library routines for them. However, the only disadvantage is..... Listed under: [LCD Projects](#), [Projects](#)

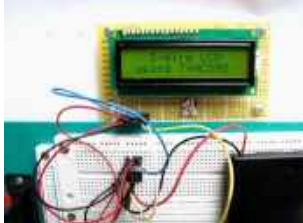

1829. [PIC18F452 to PC USB 2.0 interface with FT245BM](#) Here is an example of how to interface a PIC18F452 to a PC via the USB port. The windows-pc (98, Me, 2000, XP, 2003) runs a program (C# application, Microsoft Visual Studio .NET 2003) to communicate with the USB interface, which transfers data to and..... Listed under: [Interfacing\(USB - RS232 - I2c -ISP\) Projects](#), [Projects](#)



1830. [Solar tracking system using pic microcontroller](#) Step 1: Introduction The PV applications could be grouped according to the scheme of interaction with utility grid: grid connected, stand alone, and hybrid. PV systems consist of a PV generator (cell, module, and array), energy storage devices (such as batteries), AC and DC consumers..... Listed under: [Security - Safety Projects](#)

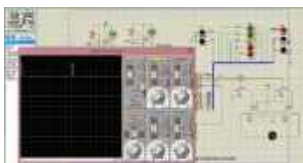



1831.  [Low cost ICSP PIC-programmer using PIC16F648A](#) Galvanic from PC isolated PIC programmer The Wisp648 from www.voti.nl is an In Circuit Serial Programmer to program a flash PIC which mostly can stay in your circuit. No irritating doings like pulling the PIC out of the PCB, place it in the programmer, programming..... Listed under: [Interfacing\(USB - RS232 - I2c -ISP\) Projects](#), [Microcontroller Programmer Projects](#), [Projects](#)
1832.  [Low cost LCD module interface with optional LED backlight using PIC18F452](#) Here are the technical specifications: LCD resolution: 128 x 64 pixels LCD manufacturer: DisplayTech. LCD model 1: 64128COG-FA-BC (no backlight) LCD model 2: 64128G-FC-BW-3 (white LED backlight) On-glass lcd controller KS0713, with 30 pins connector. Very low power operation (less than 1mA @3V) Fast serial..... Listed under: [Interfacing\(USB - RS232 - I2c -ISP\) Projects](#), [LCD Projects](#), [LED Projects](#), [Projects](#)
1833.  [DS1820 Arbiter V2.00 Schematic / Parts List](#) RS232 Connection Notes See the RS232 reference to determine the wiring for either a 9-way or 25-way female D Type "sub-miniature" connector. RTS and CTS are connected together. RXD is used to steal a negative supply. You may have to connect DSR and DCD to DTR..... Listed under: [Other Projects](#)
1834.  [MOTM Compatible Dual Channel Quantizer](#) Introduction: This describes my original design dual channel quantizer inspired by Chris List's ARP Style CV Quantizer design. My new implementation is an intelligent design that exploits the programmability of a Microchip PIC16F84. It will quantize voltages in 1/12 volt (semitone) or 1 volt (octave)..... Listed under: [Metering - Instrument Projects](#)
1835.  [Single button code entry for a digital lock using PIC16F628A](#) The Button Code is a system that allows a single button to act as a keypad. The user enters a 4 digit code into the system using button taps. The button can be placed where the public can access it since like a keypad there..... Listed under: [Projects](#), [Security - Safety Projects](#)
1836.  [Voltmeter Ammeter Kit - Blue Backlight LCD](#) Voltmeter Ammeter is a great kit to measure voltage and current at the same time. It measures 0-70V or 0-500V voltage with 100mV resolution and current from 0 to 10A. It's a perfect addition to any power supply, battery chargers and other electronic projects where..... Listed under: [LCD Projects](#)
1837.  [PIC micro Timer Code](#) Here's the minimal code to make timer 1 (a 16 bit timer) work using PICBasic. General descriptions of PIC timer variables used to control the timer: (you should be able to use these no matter what programming language you use): T1CON.0 is the first bit..... Listed under: [Microcontroller Programmer Projects](#)
1838.  [Long Period Astable Timer using PIC12F629](#) Description This software functions as a long period astable multivibrator. The mark and space period can be set from 1 second up to a maximum 65535 seconds (18h12m15s). Using the internal 4Mhz RC oscillator delays with an accuracy of 99% or better can be achieved ..... Listed under: [Clock and Timer Projects](#)
1839.  [Voltmeter Ammeter Kit](#) Voltmeter Ammeter is a great kit to measure voltage and current at the same time. It measures 0-70V or 0-500V voltage with 100mV resolution and current from 0 to 10A. It's a perfect addition to any power supply, battery chargers and other electronic projects where..... Listed under: [Metering - Instrument Projects](#)
1840.  [Digital Meter Adapter - DMAD](#) Adding a Digital Meter and Functions to Analog Geiger Counters The Digital Meter Adapter is a expansion module for adding digital functions to Analog Geiger Counters that have a pulse output. If you're geiger counter outputs a ttl pulse for every radioactive particle it detects,..... Listed under: [Metering - Instrument Projects](#)
1841.  [TinyWireMCP23008 - MCP23008 library for ATtiny85 microcontroller](#) If you want to know more... If you want to know more about ATtiny85 microcontroller and how to upload sketches to it, you may have a look to ATtiny85 vs ATmega328. About TinyWireMCP23008 was tested (and works) with a 8 MHz ATtiny85 and I2C standard..... Listed under: [Interfacing\(USB - RS232 - I2c -ISP\) Projects](#)
1842. [Nokia 1100 LCD Interfacing with Microcontroller](#) Displaying content on a normal alphanumeric display is very limited ,we have to be limited with the font size and we can't draw any graphics also. but convention Graphics lcd are really very expensive so here is the solution, you can use Nokia 1100 monochrome..... Listed under: [Interfacing\(USB - RS232 - I2c -ISP\) Projects](#), [LCD Projects](#)

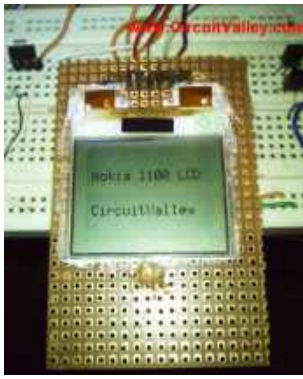

1843. [A PIC-Based Temperature Alarm using PIC16C84](#) Presented is a simple temperature alarm which uses a PIC16C84 microcontroller and a 2-line LCD display. The alarm displays current temperature in both Celsius and Fahrenheit degrees and features a 3-key keypad which allows the user to set independent high and low temperature alarm points..... Listed under: [Projects](#), [Security - Safety Projects](#)



1844. [Serial to PIC Interface using PIC Microcontroller](#) One of the first things I like to do when creating a new project is to get the I/O working. This helps in debugging the code as I write it. What about projects that do not have I/O? This device sneaks both input and output..... Listed under: [Interfacing\(USB - RS232 - I2c -ISP\) Projects](#), [Projects](#)

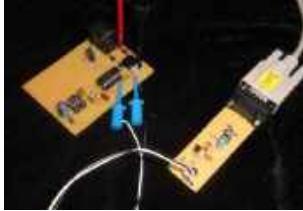

1845. [DIY, Microcontroller-Based Battery Monitor for RC Aircraft](#) I've had good cause to be reading and perusing a few old Circuit Cellar articles every day for the past several weeks. We're preparing the upcoming 25th anniversary issue of Circuit Cellar, and part of the process is reviewing the company's archives back to the..... Listed under: [Battery Projects](#)



1846. [Whistle Key Finder using PIC12F629](#) This project uses one of the smallest chips in the PIC microcontroller range, the PIC12F629 and you can learn to program it and experience the thrill of making something yourself and see what goes into writing a program. Even a program as simple as this..... Listed under: [Projects](#), [Sensor - Transducer - Detector Projects](#)



1847. [Telephone operated remote control using PIC16F84A microcontroller](#) This design controls up to 8 devices using a PIC microcontroller (PIC16F84A) connected to the phone line. The unique feature here is that unlike other telephone line based remote control, this device does not need the call to be answered at the remote end so..... Listed under: [Home Automation Projects](#)



1848. [Serial communication with Matlab pic-microcontroller](#) Overview Matlab has a "serial" function that allows it to communicate through a serial port. This project is to establish serial port connection with the PIC microcontroller and demonstrate bidirectional communication between the PIC and a Matlab program. For demonstration purposes, the PIC will send..... Listed under: [LED Projects](#)



1849. [GPS to SD-Card Data Logger using PIC16F819 microcontroller](#) Description This project combines a GPS receiver module, a MicrochipPIC microcontroller and a Secure Digital memory card to make a GPS data logger. With a large capacity and reasonably long battery life it is a very useful device for logging GPS position for example for..... Listed under: [GPS Based Projects](#), [Memory - Storage Projects](#), [Projects](#)



1850. [PIC12F675 software UART \(bit banging\) code and Proteus simulation](#) This post provides the software UART (Bit Banging) code for PIC12F675 microcontroller (e-g to connect PIC controller with PC using serial adapter). As we know, PIC12F675 microcontroller doesn't have built in UART module, so we can create UART functionality in it's software. This post provides the details..... Listed under: [How To - DIY - Projects](#), [Projects](#)



1851. [PIC-Bot II](#) On this page I hope to provide more details than I usually provide for those who wish to construct their own PIC-bot, realising that people actually try to make this stuff. Traditionally, my 'bot pages are for documenting the essentials, not in the kind of..... Listed under: [Other Projects](#)

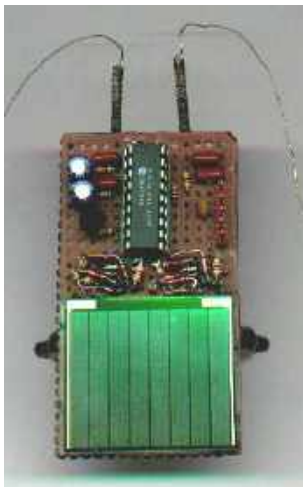

1852. [Original PICKIT-2 microcontroller programmer](#) These days I was thinking about a better PIC programmer that can work with MicrochipMPLAB IDE software so that I can write my own programs or edit someone else's programs. I found that there are numerous versions of the famous Microchip PICKit 2 on the..... Listed under: [Microcontroller Programmer Projects](#)



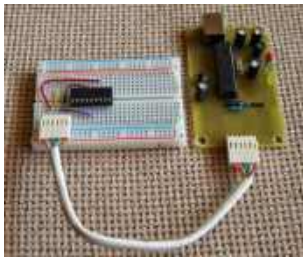

1853. [PIC 16C84 VT-52 Emulator for Linux](#) Features Fits in one half height 5.25" drive bay. Back light 16 x 2 lines LCD (Hitachi Compatible) display. 4 Selection buttons, arranged so that it looks like an ATM machine. RS232 19,200 baud connection to PC with Hardware handshaking (CTS). Uses a subset of..... Listed under: [LCD Projects](#)



1854. [SD/SDHC CARD SOUND RECORDER](#) Updated on 30.6.2015 The PIC16F876A's ADC digitizes the sound and store it in the SD or SDHC card. The firmware works for SD or SDHC cards only, for old SD (before 2009) use ver1 firmware. Do not use SDXC cards with this project because some..... Listed under: [Sound - Audio Projects](#)

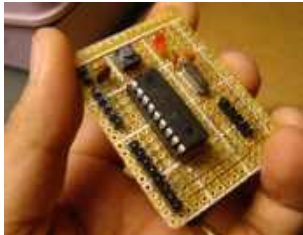

1855. [Breadboard module for PIC16F628A](#) Here's another breadboard module that carries a PIC16F628A microcontroller. The power supply pins and the I/O ports of the PIC16F628A microcontroller are accessed through male headers. It can be easily plugged into a breadboard and is very useful for quick prototyping. It frees up a..... Listed under: [Development Board - Kits Projects, Projects](#)

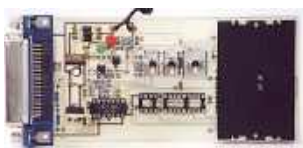

1856. [PIC programmers for parallel port](#) uni5\_a.bmp - PCB of parallel programmer UNIPROG V-A uni5\_as1.bmp - schematic diagram of G.Tait's programmer with 4066 uni5\_ao1.bmp - layout of components of G.Tait's programmer with 4066 List of components: 1 x slot for ISO card (eight pins are enough) 1 x female Centronix connector..... Listed under: [Microcontroller Programmer Projects](#)



1857. [Fun with PCBs](#) Last year I bought this Etch-Set For Electronic Circuits from Jaycar with the intention of having a go at making my own printed circuit boards (PCBs). I'd had lots of experience working with those experimenter's Stripboards and Perfboards, which had been more than sufficient for..... Listed under: [Game - Entertainment Projects](#)

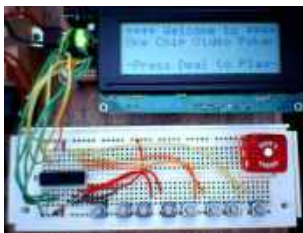

1858. [One Chip Video Poker using PIC16F628 microcontroller](#) This is a simple video poker game for the PIC 16F628 and a 20x4 character LCD. It's written in PIC assembly for MPASM. I started the project in 2002. I originally intended it as a birthday present for my brother, who is an enthusiastic if..... Listed under: [Game - Entertainment Projects, Projects](#)

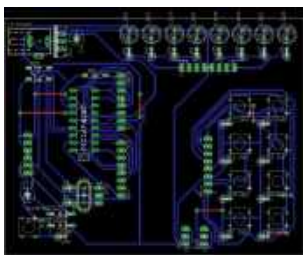

1859. [18 pin PIC Development Board using PIC16F62](#) 18 pin PIC Development Board I have long been playing with Microchip PICs but have always made do without some form of development board. To that end I have designed a basic board that I was hoping to get some input for. I haven't yet..... Listed under: [Other Projects, Projects](#)

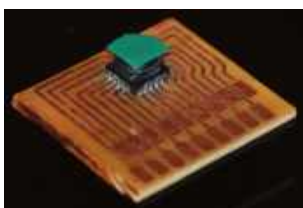

1860. [PCB layouts using CAD](#) Now the PCB kit I used described how I could draw my circuit layouts directly unto the copper clad board using an special pen with etch-resistant ink, however lacking the dexterity of an artist I chose to get myself some CAD software for generating PCB..... Listed under: [Other Projects](#)



1861. [DIY Bluetooth RC Car](#) Last year I started a project to convert my (then) four-year old's busted Radio Controlled (RC) car into Bluetooth controlled one which could be driven using a smart phone or tablet. The original car, modeled after a "Fast and Furious" Nissan Silvia, was a pretty basic RC..... Listed under: [Bluetooth Projects](#)

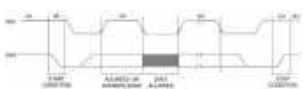

1862. [How to Interface I2C External EEPROM 24LC64 to PIC Microcontroller](#) Microcontrollers are standalone chips since they have memory and processor embedded. The integrated memory of microcontrollers store embedded code and other temporary variables for the execution of program. CircuitsGallery published many microcontroller tutorials and PIC microcontroller projects. Sometimes we may use non-volatile memories (i2c devices)..... Listed under: [Interfacing\(USB - RS232 - I2c -ISP\) Projects](#)

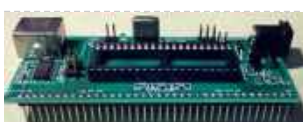

1863. [Capacitance Meter MkII using PIC12F629](#) This project is specially designed to measure surface mount capacitors in the range 1p to 920n and electrolytics in the range 1u to 100u. The biggest problem with surface mount capacitors . . . they are not identified! And you cannot determine their value by..... Listed under: [Metering - Instrument Projects, Projects](#)

1864. [SL4A Bluetooth Controller](#) Having had a bit of an unproductive Easter break I think it's about time I got back to posting the concluding details of how the transmitter for the Bluetooth RC was implemented. I built the PIC-based motor and servo controller before acquiring the BlueSMiRF module..... Listed under: [Bluetooth Projects](#)



1865.

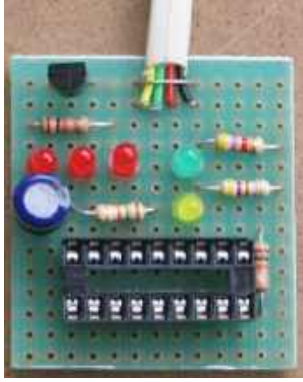

[PIC PROGRAMMER MkV using PIC12F629](#) PIC Programmer MkV is designed to get you into PIC Programming for just a few dollars. It uses just 12 components. Most of them will be in your "junk-box" and the PC board is a small piece of matrix board. It's the cheapest way to..... Listed under: [Blog](#), [Microcontroller Programmer Projects](#), [Projects](#)

1866.



[GSM Modem Interface with PIC 18F4550 Microcontroller](#) GSM Modem Interface with PIC 18F4550 Micro controller: Description: In this project we use PIC 18F4550 Micro controller in transmitter section keys are connected to PB0 to PB3. If we press the key PB0 the Pressed Key Value is transmitted to the micro controller section..... Listed under: [Interfacing\(USB - RS232 - I2c -ISP\) Projects](#)

1867.



["Fluffy" – A Scenix \(and PIC\) Programmer](#) I was trying to think of a suitable name for this project, and after literally seconds of careful deliberation, I gave up and decided to call it Fluffy. Sorry. Anyway, Fluffy is a SX programmer for people who have already experimented with PIC chips, and want..... Listed under: [Microcontroller Programmer Projects](#)

1868.

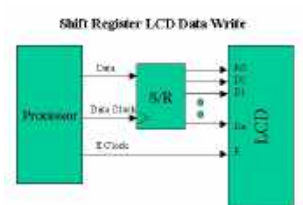

[Build your own "2-Wire LCD Interface" using the PIC16C84 microcontroller](#) 2-Wire LCD Interface for the PICMicro Alphanumeric LCD displays have become very popular for microcontroller applications because they can add a lot to a project in a variety of different ways. A text message giving the user instructions as well as feedback can make the..... Listed under: [LCD Projects](#)

1869.



[8 Channel PWM LED Chaser for 16F628A and 16F88](#) Description This neat little circuit provides 8 LEDs directly driven from the PIC along with a single mode control switch. The firmware elsewhere on this page drives the LEDs with a 5 bit PWM signal providing each of the 8 LED channels with four levels..... Listed under: [LED Projects](#)

1870.



[Rubidium Atomic Clock](#) Introduction In the 1970s I worked for a while for the UK Atomic Energy Authority (UKAEA) at a site in Winfrith, Dorset. Amongst a lot of other interesting work, I used a gamma ray density gauge that amounted to a caesium-137 source, in its castle..... Listed under: [Clock and Timer Projects](#)

1871.



[SMS Based Device Control using GSM Modem](#) It has been a while since we published electronic engineering projects here due to the busy schedule we had in the past weeks, and this time we're up with another interesting project. Before going through the details of this one, you may as well check..... Listed under: [Home Automation Projects](#)

1872.

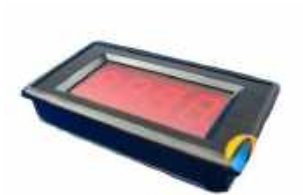

[0-5V LCD volt meter using PIC16F877A](#) This PIC LCD volt meter project uses a PIC micro and an HD44870 LCD display. The analogue input is taken directly to the analogue input pin of the microcontroller without any other processing. So the input range is from 0V to 5V - the maximum..... Listed under: [LCD Projects](#), [Metering - Instrument Projects](#), [Projects](#)

1873.

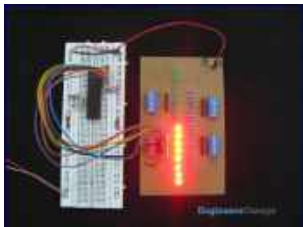

[How to interface LEDs with PIC18F4550 Microcontroller](#) It is necessary to understand basic I/O operations of PIC18F4550 before dealing with its complexities. This article presents a way to take simple output from a PIC microcontroller. This learning would also help in interfacing of external devices with the controller. Here the output from..... Listed under: [Interfacing\(USB - RS232 - I2c -ISP\) Projects](#), [LED Projects](#), [Projects](#)

1874.



[Simple Digital GPS Speedometer Using PIC16F877A with LCD Display](#) Speedometer is a speed measuring gauge used to calculate the speed of motor vehicles. They are mainly of two types- electronics and mechanical. Digital speedometer measures the speed and mileage in vehicles. Normally both types work on the principle of electromagnetism, however they have a..... Listed under: [LCD Projects](#), [Metering - Instrument Projects](#)

1875. [Electronic Die using PIC16F84 microcontroller](#) Built using a PIC16F84, about 4 hours worth of code and a few bits on a breadboard. This was the first time I've worked with PIC's so it was a learning exercise. I started with the 'Hello World' microcontroller equivalent i.e. Blinking LED, then tried..... Listed under: [Development Board - Kits Projects](#), [LED Projects](#), [Projects](#)



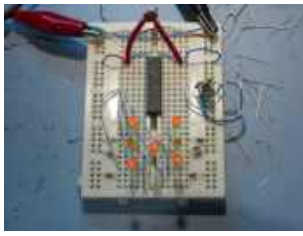

1876.

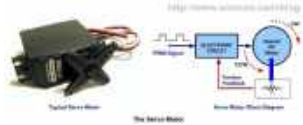

[Servo Motor Control using Microcontroller PIC16F877A](#) Servo motors are widely used in robotics and industries for motion control. They can be controlled by PWM signals where the required angle of rotation can be located by a particular PWM signal. So In this article we'll see in detail on PWM servo control..... Listed under: [Motor Projects](#)

1877.

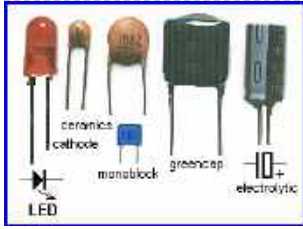

[TAXI PHONE](#) This project is a dedicated device. It dials a single phone number when the handset is lifted. There are two different modes of operation.. A slide-switch on the PC board allows the project to operate in automatic or manual mode. If the switch is in..... Listed under: [Phone Projects](#)

1878.

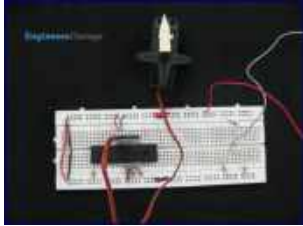

[How to interface Servo Motor with PIC18F4550](#) Servo systems use the error sensing negative feedback method to provide precise angular motion. Servo Motors are used where precise control on angular motion is needed. Servo motors are widely used in the field of Robotics to design robotic arms, palms, legs and so on..... Listed under: [How To - DIY - Projects](#), [Motor Projects](#), [Projects](#), [Tutorials](#)

1879.



[Getting started with PIC Microcontroller Programming](#) What is a PIC Microcontroller? PIC (Peripheral Interface Controller) is a microcontroller family developed by the Microchip Technology. It plays important role in embedded systems. Low cost, serial programming capability, reprogramming of the flash memory, availability of free developing tools, large user database, etc. are some..... Listed under: [Microcontroller Programmer Projects](#)

1880.

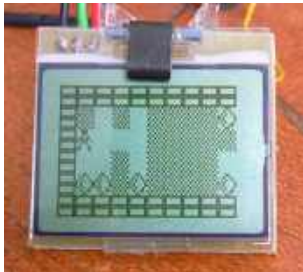

[3310 Nokia LCD & PIC12F683](#) Not long ago I saw this link for a 3310 temp probe. Now ive played with other LCD's lots, but this one caught my attention because of the low power requirements (It runs from a single CR2032 Motherboard battery). I built the Temp probe as..... Listed under: [Interfacing\(USB - RS232 - I2c -ISP\) Projects](#), [LCD Projects](#), [Projects](#)

1881.



[Project Ryu Lager – Guitar Effect](#) Do you remember BOSS Slow Gear pedal? If your a guitarist you most likely do or at least you've heard of it. It was a great pedal sold from 1979 to 1982 and it was made in Japan. The pedal would cut the attack of..... Listed under: [Sound - Audio Projects](#)

1882.



[Rev 4.2.2 schematic and PCB](#) A long while back I posted a version of the schematic for the electronics for my project to build a GPS-steered parachute for rocket recovery. Since then I've tweaked the board a bit, to the point where the hardware design is clean and bug-free (as..... Listed under: [Development Board - Kits Projects](#)

1883.



[Enhanced 5/2-day Central Heating Programmer with serial computer interface using PIC16F628A](#) Overview This project has come about from my desire to control my home heating from work. As I have a VPN between work and home a straightforward relay controlled from a PC would seem the easiest solution. However I also wanted a control unit that..... Listed under: [Home Automation Projects](#), [Interfacing\(USB - RS232 - I2c -ISP\) Projects](#), [Microcontroller Programmer Projects](#), [Projects](#), [Temperature Measurement Projects](#)

1884.

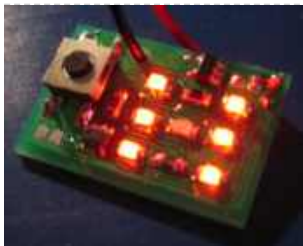

[PIC10F200 based dice](#) This page describes a PIC10F200-based electronic dice. The reason I made this was that I got a small corner left over when ordering a panel with a couple of other PCBs and thought I would rather use the corner for something fun than leave it..... Listed under: [LED Projects](#)

1885.



[Humidity and temperature measurements with Sensirion's SHT1x/SHT7x sensors using PIC18F2550 \(Part 1\)](#)

Temperature and relative humidity are two very important ambient parameters that are directly related to human comfort. Monitoring these factors becomes even more crucial in various applications such as environmental control systems and indoor climate management. Integrating sensors like the Sensirion SHT1x/SHT7x can provide precise..... Listed under: [Projects](#), [Sensor - Transducer - Detector Projects](#), [Temperature Measurement Projects](#)

1886. [Solar Recorder](#) The device used for measuring daily insolation has been developed. The device was built with a PIC18F458 and the 128MB Multimedia Memory Card, MMC. The solar radiation is measured by a calculator solar cell. The PIC chip interfaces the MMC using SPI mode. The interval..... Listed under: [Other Projects](#)

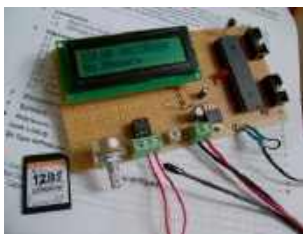

[Mechanically scanned RS232 display \(with dynamic speed\)](#) Introduction After I made the clock, the pong and tetris games I thought that it also would be cool to connect the game system to a standard rs232 port and scroll text coming from the port. When I thought about it, I found that there..... Listed under: [Metering - Instrument Projects](#)

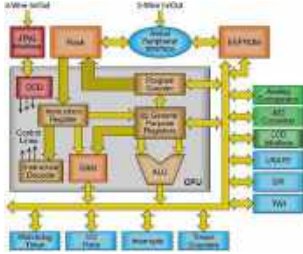

[How to choose a MicroController using PIC16C84 microcontroller](#) How to choose a MicroController It used to be that the number of different microcontroller chips available to the hobbyist was pretty limited. You got to use whatever you could manage to buy from the mail-order chip dealer, and that narrowed down the choice to..... Listed under: [Development Board - Kits Projects](#), [LCD Projects](#), [Projects](#)



[MikroElektronika's "Ready for PIC" board talks to "Processing" using PIC16F887](#) "Ready for PIC" is one of MikroElektronika's compact prototyping boards for 28 and 40 pin PIC microcontrollers. The board comes with PIC16F887 microcontroller which is preprogrammed with an UART bootloader firmware and thus eliminates the need of an external programmer. The on-board USB-UART module allows..... Listed under: [Clock and Timer Projects](#), [Development Board - Kits Projects](#)



[PIC16F84A LCD interfacing code \(using 3 pins only\) + Proteus simulation](#) This post provides the LCD[1] interfacing code using only 3 pins of PIC16F84A microcontroller. This code is written in C language using MPLAB with HI-TECH C compiler. You can download this code from the 'Downloads' section at the bottom of this page. It is assumed that you..... Listed under: [Interfacing\(USB - RS232 - I2c -ISP\) Projects](#), [LCD Projects](#), [Projects](#)



[Virtual Tetris](#) Introduction Tetris is a very simple, but elegant game. Blocks of four bricks each are falling down in a play field, and the player can rotate and move the block sideways. When the block hits ground or another block below, it stays there. If one..... Listed under: [Game - Entertainment Projects](#)



[Virtual Pong.](#) Introduction The game Pong was the world's first video game in the early 70's, it is a tennis lookalike game where a ball is played with two rackets, which are moved up and down by each player. The ball can bounce at the floor and..... Listed under: [Game - Entertainment Projects](#)

Hz	1209	1336	1477	1633
697	1	2	3	A
770	4	5	6	B
852	7	8	9	C
941	*	0	#	D

[DIAL ALARM-1](#) This is the lowest cost dialing alarm on the market and shows what can be done with an 8-pin microcontroller. The complete circuit is shown below. You cannot see all the features of this project by looking at the circuit - most of them are contained in..... Listed under: [Clock and Timer Projects](#)



[Embedded Linux Controller using pic microcontoller](#) An In-Circuit Debugger (ICD) is a very powerful and effective tool for real-time debugging of a microcontroller-based system at hardware level. It allows you to run, halt and single step the program while the target microcontroller is embedded in the actual circuit. Once halted, the program variables, Special Function Registers..... Listed under: [LCD Projects](#)



[Virtual Game System – A game console with a mechanically scanned display.](#) Introduction If you move a bright light fast by the eyes, it will leave a line behind because the human brain and eyes are slow to interpret fast changes in light intensity, leaving an afterglow. If a row of LED's is moved sideways while the..... Listed under: [Game - Entertainment Projects](#)

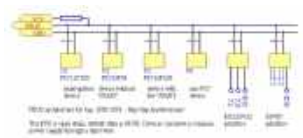

[PBUS – an RS485-like multi-drop bus with half duplex serial protocol](#) overview There are three PIC source versions: PB12 is for 12-bit slave devices without interrupt PBUS is for slave devices with an interrupt, software UART implementation PB628 is for slave devices with an interrupt and a free hardware UART PBUS assigns a unique device ID..... Listed under: [Other Projects](#)



[Build yourself flashing message on PIC16F877A with assembler](#) Guys, in this step by step instruction, I wanna share my private experiment with PIC16F877A and assembly language, I call it Build yourself flashing message on PIC16F877A with assembler Let's prepare the parts Step 1: The parts needed for this experiment 1. PIC 16F877A chip..... Listed under: [Other Projects](#)

[Displaying text on LCD by interfaced with PIC16F877 microcontroller in 4 bit mode](#) Here I discuss on very good and simple project on displaying text on LCD by interfaced with PIC16F877 microcontroller in 4 bit mode.to start with this project you need some Knowledge on how to start project on PIC micro controller I assumed you know that..... Listed under: [Interfacing\(USB - RS232 - I2c -ISP\) Projects](#), [LCD Projects](#)





1899. [SX-Pong](#) After making the tetris game, it was very easy to make a Pong game. The game Pong was the world's first video game in the early 70's; this is a modern version of it, made with a little bit less hardware than the original version..... Listed under: [Game - Entertainment Projects](#)



1900. [Leaving home light using PIC12F675 Microcontroller](#) Those days when I come home at night and strait into the darkness are finally over. This is a very practical device and I built it so that it is a module to my Dual Channel IR Remote Control. Because of that I ended up..... Listed under: [Home Automation Projects, Projects](#)



1901. [SX-Tetris](#) The first game I made in color using SX-chips was Tetris. Tetris is an old Russian computer game where you should try to fit in block into a play-field, quite simple but really fun. All blocks are built from four bricks (the name Tetris is..... Listed under: [Game - Entertainment Projects](#)



1902. [Microchip PIC Microcontrollers](#) Implementing ICSP requires connections to a minimum of 5 processor pins: VDD, VPP (also MCLR), SCLK (on RB6), SDAT (on RB7), and GND. VDD and GND are straightforward. In most applications, it is best to dedicate RB6 and RB& for SCLK and SDAT. This avoids..... Listed under: [Development Board - Kits Projects](#)



1903. [Revised version of LM35 based digital temperature meter using PIC16F688](#) This is a revised version of my LM35 based digital thermometer project that I posted last year. Although it is one of the simplest projects, it is very popular among newbies who are just starting to learn microcontrollers. There was a little flaw in the original..... Listed under: [Metering - Instrument Projects, Projects, Temperature Measurement Projects](#)



1904. [SX Game System](#) This page describes a SX28-based color video game system I made during year 2002. Now, beginning of 2007, almost five years after I made the first design I've updated the layout of the PCB and added a version of the PCB that has built-in gamepads..... Listed under: [Game - Entertainment Projects](#)



1905. [PIC-Tetris](#) Introduction I have made the game Tetris using a PIC16F84 running @ 12MHz. Tetris is an old Russian computer game where you should try to fit in block into a play-field, quite simple but really fun. All blocks are built from four bricks (the name..... Listed under: [Game - Entertainment Projects](#)

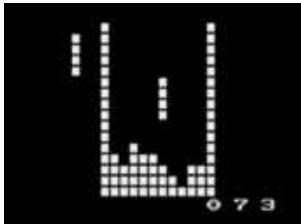

1906. [Chronograph for Air Cannon using PIC16F628A microcontroller](#) Intro: Chronograph for Air Cannon This chronograph project consists of a sensor assembly and timer circuit box that can be used to measure the muzzle velocity of a projectile fired from an air cannon. I originally built this setup for use with a large air..... Listed under: [Other Projects, Projects](#)



1907. [Building the PIC16F84 based game system](#) This text describes how to build my PIC16F84 based game system, before you start you should read through the whole text one time. Note that many components are sensitive to too much heat and will get damaged if you heat them too much when soldering..... Listed under: [Game - Entertainment Projects](#)

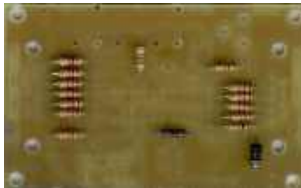

1908. [Interfacing the AT keyboard.](#) PC Keyboard Theory The IBM keyboard you most probably have sitting in front of you, sends scan codes to your computer. The scan codes tell your Keyboard Bios, what keys you have pressed or released. Take for example the 'A' Key. The 'A' key has..... Listed under: [Interfacing\(USB - RS232 - I2c -ISP\) Projects](#)











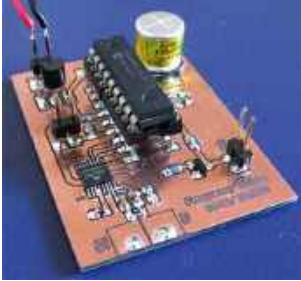

1909. [Pulsing Hubby Detector using PIC12f683 microcontroller](#) Pulsing Hubby Detector This project uses an RF receiver module to trigger a pulsing LED Heart when the transmitter comes within range. I made this for my fiance for Valentine's Day this year. I have yet to fully test the range, as I haven't actually..... Listed under: [LED Projects, Projects](#)

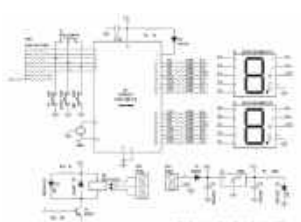

1910. [PIC Game System](#) This page describes a PIC16F84-based video game system I made and first published back in the beginning of 1998. Now, beginning of 2007, nine years later I've updated the layout of the PCB and also updated the source code to also be able to run..... Listed under: [Game - Entertainment Projects](#)



1911.  [Poor man's counter using PIC16F84 microcontroller](#) Background Most multimeters can measure frequency, but they are not sensitive and the max frequency is not always so high. The same problem can be found with older frequency counters. This project will describe a prescaler which will work up to 2.5GHz and with very..... Listed under: [Other Projects, Projects](#)
- 
1912.  [How to make a 'Propeller Display' using PIC microcontroller](#) This is my first post Related to Projects and today i will describe 'Propeller Display' project. Me and my friend Rushi, we both made 'Propeller Display' project during our under-graduation. Below is the photo of the project. Project uses Microchip PIC16F84A Microcontroller. Below is the..... Listed under: [Development Board - Kits Projects](#)
- 
1913.  [Pic 16F676 ICSP programing socket for the PICkit 2 programer](#) I'm trying to build this dual DC motor module for my robot project And I did not have the space for placing an ICSP pin header on the PCB. So i quickly mocked up this design. Step 1: Getting the parts Well to build the..... Listed under: [Interfacing\(USB - RS232 - I2c -ISP\) Projects, Microcontroller Programmer Projects](#)
- 
1914.  [Max the Spider – powered by LEGO and PIC microcontroller](#) So Max the spider visited us in the lab today, and wanted to get into the halloween spirit. "I'd like to drop down on people in the elevator," he smirked, in a way only a spider could. "I've got just the thing," I winked, and..... Listed under: [Game - Entertainment Projects](#)
- 
1915.  [Open Source Framework for USB Generic HID devices based on the PIC18F and Windows](#) Introduction If you've dabbled with PIC18F microcontrollers and the USB Generic HID standard before (perhaps you've even tried my Building a PIC18F USB device project) then you will have noticed that there is a lot of complexity in supporting USB on both the PIC18F and the..... Listed under: [Interfacing\(USB - RS232 - I2c -ISP\) Projects](#)
- 
1916.  [Mechanically scanned laser display using PIC17F877](#) Abstract This application is a very cheap solution for displaying text messages on a solid or semi-opaque surface by using a laser beam. The main goal was to verify the possibility to build a simple and cheap display for displaying large text. The basic idea..... Listed under: [LCD Projects, Projects](#)
- 
1917.  [2 Digit 99 Seconds Timer](#) 2 Digit Count Down Timer is a utility Count Down timer project for upto 99 seconds of countdown time. This project can find many uses in your shack and home. The relay output remains on during the Count Down period, allowing you to interface load..... Listed under: [Clock and Timer Projects](#)
- 
1918.  [LED dot matrix scrolling message – 14x5 – source code](#) I have built various scrolling message badges for instance using the 16F57- 10x5 and 12x5. However, since these chips only have a small FLASH, there is not much flexibility. I don't really recommend these controllers for a scrolling message. Recently I have started a new..... Listed under: [LED Projects](#)
- 
1919.  [2meter \(144MHz\) amateur radio transceiver](#) I designed , built, tested and operated a 2m hamradio transceiver that includes all the necessary circuitry, in particular the voltage-controlled oscillator (VCO) + phase-locked loop (PLL) for frequency synthesis, low noise amplifier (LNA) for the receiver front-end, power amplifier (PA) for the radio frequency..... Listed under: [Radio Projects](#)
- 
1920.  [9 Volt Battery Charger](#) 9 Volt batteries extensively used in various electronics measurement equipment. Powering these devices with rechargeable batteries can be a cost effective solution. In this post a simple Lithium-ion 9 Volt Battery Charger design with overcharging protection will be presented. Charger is based on PIC16F876A microcontroller..... Listed under: [Battery Projects](#)
- 
1921.  [Car battery charger with PIC12F683](#) This time I'm starting off with a device I already built, unfortunately there won't be any photos from the actual build, just a quick article on how I imagined it and how it works. A short story about how the whole thing started My uncle..... Listed under: [Battery Projects](#)
- 
1922. [Motion Activated Led Dice using PIC16F688](#) Introduction I've always wanted to build an electronic led dice, but something different from what we see on the internet. Making it motion controlled... now that's new! Many new cell phones that have accelerometers built in also have dice games. These dice move..... Listed under: [LED Projects, Projects](#)





1923.

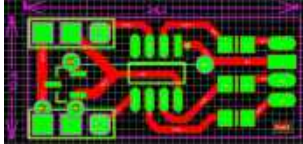

[Microprocessors Garland](#) 1. Presentation For some time now, I think the commercially available garlands, are too boring, too repetitive with their two or three alternations of colored bulbs. I wanted to create a truly personalized one without ruin me either. Two ideas immediately came: - a microprocessor..... Listed under: [LED Projects](#)

1924.



[PIC16F84 Fundamentals](#) The photo shows a PIC16F84 microprocessor board tethered, by ribbon cable, to a circuit having 8 LEDs and an 8-position DIP switch. Learning a microprocessor's capabilities often demands such a setup where LEDs turn on/off, blink at desired rates and respond to switches. This tutorial..... Listed under: [Interfacing\(USB - RS232 - I2c -ISP\) Projects, Projects](#)

1925.



[internetworking with microchip microcontroller pic18f+enc28j60](#) Description The ENC28J60 is Microchip's first incursion into the ethernet controller arena, this new device includes all MAC & PHY IEEE 802.3 10BaseT functions, 8KB of dual access RAM packet buffer and a SPI serial interface, all in a convenient 28-pin package (SPDIP, SOIC, SSOP)..... Listed under: [Microcontroller Programmer Projects](#)

1926.



[Building a PIC18F USB device](#) Introduction I get a number of emails every month asking about creating USB devices using the PIC18F microcontroller. After looking at projects such as my Atari Joystick USB Adaptor and C64 VICE Front-End there seems to be a demand for more information on how to..... Listed under: [Development Board - Kits Projects, Interfacing\(USB - RS232 - I2c -ISP\) Projects, Projects](#)

1927.



[PIC12F1840 + I2C 24FC1025 EEPROM](#) The 24FC1025 is a serial I2C EEPROM memory fabricated by microchip, it has 1024Kbits (128KB) of memory space and it is divided in two parts each one of 512Kbits (64KB); the first part goes from address 0x0000 to 0xFFFF and the second part goes from..... Listed under: [Memory - Storage Projects](#)

1928.



[Simplest Temperature Data Logger using PIC12F683](#) Introduction There are varieties of digital temperature logger projects available online based on different microcontrollers. The one I am going to talk about is based on a Microchip's 8-pin microcontroller, PIC12F683. It reads temperature values from a DS1820 digital sensor and stores in its internal..... Listed under: [Projects, Temperature Measurement Projects](#)

1929.



[Quozl's Alarm Clock using PIC16F877](#) Old Alarm Clock Problems wake's Quozl's wife, a side-effect, needs to be armed each evening, 12-hour clock, cannot be armed more than 11.5 hours before alarm time, triggers at plus or minus ten minutes, depending on how it was dropped, battery cover needs to be..... Listed under: [Projects](#)

1930.

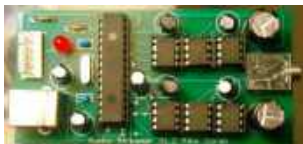

[USB Audio Streamer A Microchip PIC based USB sound card](#) INTRODUCTION The idea for creating a USB sound card based on a PIC came from discussions of other people creating one on the Microchip USB forum. The hardware of the card is based on all Microchip products. The software uses a modified version of the..... Listed under: [Interfacing\(USB - RS232 - I2c -ISP\) Projects, Sound - Audio Projects](#)

1931.



[Using Digole 12864ZW LCD with PIC18F](#) Digole 12864ZW is a 128x64 pixels graphic LCD that can be found at attractive prices and this is why it started appearing in projects across the web. It is based on ST7920 chip which is not so well known and to me it wasn't the..... Listed under: [LCD Projects](#)

1932.



[Cheap PIC Programmer using PIC16F84 microcontroller](#) Cheap PIC Programmer This programmer works only with PIC16F84 but it's great because it never causes errors and works with almost all computers,unlike some other homemade programmers. Step 1: Step one : Materials For this programmer you won't need many materials.In fact , you will..... Listed under: [Microcontroller Programmer Projects, Projects](#)

1933.



[PIC microcontroller ATA library](#) This project started life a long time ago, with the intention to build an iPod clone, back when personal MP3 players were an expensive luxury and long before you could buy them from China on ebay for less than a light bulb. The plan for..... Listed under: [Interfacing\(USB - RS232 - I2c -ISP\) Projects](#)

1934.

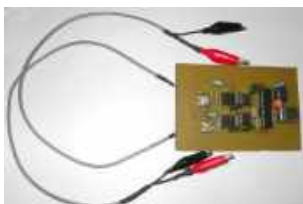

[Two-Channel PC Based Oscilloscope USB](#) Inroduction More and more experiments are now 'PC-assisted.' Also conventional acquisition systems are very expensive. Since portable PCs are today common and a USB link is a better solution here we present an oscilloscope using USB port of the PC that operates at up to 10 kHz with  $\pm 16V$  input voltage. It has..... Listed under: [Interfacing\(USB - RS232 - I2c -ISP\) Projects](#)

1935. [3-Channel IR Relay Controller with user programmable IR commands for PIC12F629](#) Description This project is a 3 channel infrared (IR) remote controlled relay driver. It works with 12-bit SIRC IR signals as used by Sony remote controls. The controller also features the ability for the user



to 'program' the commands it will respond to using the..... Listed under: [Internet - Ethernet - LAN Projects](#), [LED Projects](#), [Projects](#)

1936. 

[Hello World Project With PIC Microcontroller – Part II](#) Hello Friends, Welcome back. In the last tutorial we started working with MPLab and HI-TECH C Compiler and written our first C program to blink LED. After compiling the program we got the HEX file. Now, in this tutorial we will see how to transfer(burn) the..... Listed under: [Microcontroller Programmer Projects](#)



1937. [Balanced Line Attenuator](#) In a home recording environment equipment often doesn't come in a large variety because of either limited budget or limited space... or both. I am presenting here an balanced attenuator which comes in between fixed gain preamp and recording device/soundcard. The purpose of this device..... Listed under: [Home Automation Projects](#)

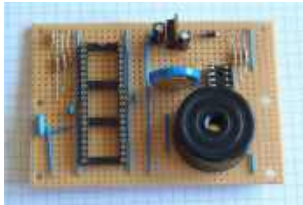

1938. [Alarm Clock using PIC16F74 microcontroller](#) The idea for this project came from my youngest son who asked me to make him an alarm clock. I put together a simple PIC based design comprising of two interlinked vero-board cards. The design was created using New Wave Concepts' LiveWire which allows you..... Listed under: [Clock and Timer Projects](#)



1939. [Ide To Usb Converter Circuit Diagram](#) How to Make Phonecall From GSM Module Using pic18f2550 ... Mplab® ide – developer – wikidot, Mplab® x integrated development environment (ide) is a software program that runs on a pc (windows®, mac os®, linux®) to develop applications for microchip. Ee times |..... Listed under: [Interfacing\(USB - RS232 - I2c -ISP\) Projects](#)



1940. [The Talking Breathalyzer Mark II using PIC18F1220](#) The Talking Breathalyzer Mark II Hi Folks! Thanks for having a gander! This is my second Breathalyzer project. IT TALKS TO YOU, and gives you an idea of how much you've had to drink! I made it specifically for for this contest. I hope you..... Listed under: [Other Projects](#), [Projects](#)



1941. [PIC 16F917 Microcontroller Programmer](#) In this instructable , I 'll show you how to build a PIC 16F917 Microcontroller programming circuit. This Microcontroller is a very nice Microcontroller chip form the famous chip manufacturer Microchip. This Microcontroller is easy to program and powerful to use. The photo above shows..... Listed under: [Microcontroller Programmer Projects](#)

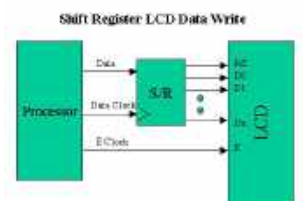

1942. [2-wire LCD interface using PIC16CF84](#) Alphanumeric LCD displays have become very popular for microcontroller applications because they can add a lot to a project in a variety of different ways. A text message giving the user instructions as well as feedback can make the application seem much more "professional" and..... Listed under: [Interfacing\(USB - RS232 - I2c -ISP\) Projects](#), [LCD Projects](#)



1943. [Building the Inchworm ICD2 PIC Programmer / Debugger](#) This instructable is an illustrated walk through building an ICD2 clone called the Inchworm. It's a straight forward kit that lets you build an MPLAB ICD2 compatible Programmer and Debugger. There are lots of Programmers out there but very few include a debugger, (A debugger..... Listed under: [Microcontroller Programmer Projects](#)

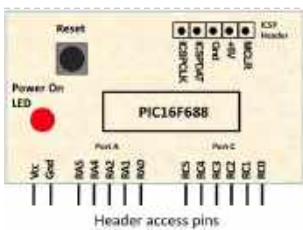

1944. [PIC16F688 breadboard module for quick prototyping](#) This module is based upon the basic setup circuit for PIC16F688 that I have described in one of my PIC lessons, Getting ready for the first lab. I thought of soldering this circuit on a general purpose ptotyping board and use male headers to access the..... Listed under: [Development Board - Kits Projects](#), [Projects](#)

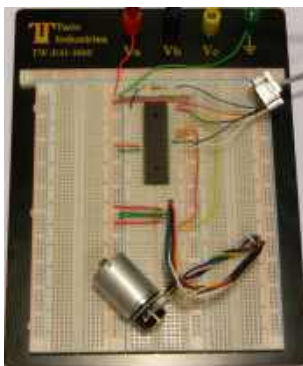



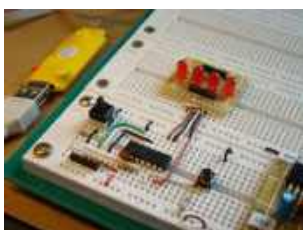













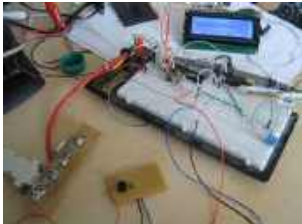

1945. [How to Program a PIC Microcontroller & Read an Encoder](#) Introduction: From electronic toys & games to microwave ovens, microcontrollers can be found just about anywhere these days! But how can we make these small computers work for our own electronics projects? That's where this tutorial comes in - with detailed instructions showing you what..... Listed under: [Microcontroller Programmer Projects](#)



1946. [Lab 3: Four bit binary counter using PIC16F688](#) Description Today's lab session is about binary counting LEDs. The binary 1 and 0 will be represented by turning LEDs on and off. You will make a 4-bit binary counter (using 4 LEDs) that counts from 0 to 15 (0000-1111 binary). The four LEDs are..... Listed under: [Clock and Timer Projects](#)

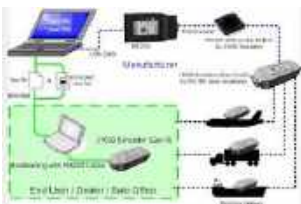
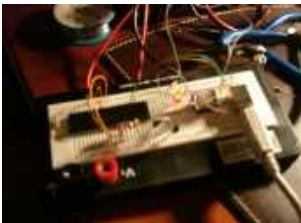
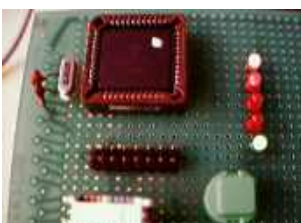

1947.  [PIC Based Oscilloscope Clock](#) For those are not into electronics, you must know that an oscilloscope has basically only one timebase to move the spot horizontally from left to right with the same intensity. The vertical deviation is function to the input voltage. You understand immediately that you can't..... Listed under: [Clock and Timer Projects](#)
- 
1948.  [Rotating Sprocket Wheel Generator using PIC16F84](#) Background My friend Arthur, in his lifelong quest for circuits that don't really do anything useful, but are really neat nonetheless, built a really neat Lissajous pattern generator. This Lissajous pattern is not your traditional circle, oval, or figure-8, it is a circle with varying..... Listed under: [Other Projects, Projects](#)
- 
1949.  [Fun with Voltage Regulators](#) I've been spending a lot of time thinking about op amps and comparators lately. One of the common uses of an op amp is as a "unity gain" buffer, meaning that the output voltage is as close as possible to being the same as the..... Listed under: [Game - Entertainment Projects](#)
- 
1950.  [Water Wave/Tide/Level Meter 2.0 using PIC16F88](#) Capacitance Probe A simple probe can be made using insulated wire. The insulation is then the dielectric of an cylindrical capacitor with the inner conductor as one plate and the water as the other. The probe is not suitable for distilled or very pure water..... Listed under: [Metering - Instrument Projects, Projects](#)
- 
1951.  [Mork Microchip PIC32MX ICSP](#) Mork is adaptation of Nanu nanu Microchip PIC ICSP for the STM32 based vcc-gnd or Maple mini. Both STM32 boards are inexpensive boards which don't cost much more than the Nano 3.0 yet they are far more powerful. One complication though for the vcc-gnd, is..... Listed under: [Development Board - Kits Projects](#)
- 
1952.  [Introducing the BOLT PIC18F2550 Microcontroller Board using pic microcontoller](#) The BOLT microcontroller board utilizes the Microchip 18F2550 with built in USB capabilities. Utilizing a 2k 'boot loader' this leaves a great deal of flash RAM for C programming using MPLAB and the C18 compiler. The BOLT board comes in two versions. LITE which has..... Listed under: [LCD Projects](#)
- 
1953.  [Ic meter capacitor inductimeter circuit pic 16f84 auto range lcmeter](#) The good and high precision capacitor meter (Capacimeter) inductor meter (inductimeter) auto range Ic meter for pic 16f84 or pic 16f628 and display lcd by phill rice Construction of an apparel that allows measure inductors (Inductimeter) and capacitors (Capacimeter), knower like LC meter, using PIC..... Listed under: [Metering - Instrument Projects](#)
- 
1954.  [Picaxe Blending Nightlight using pic12f683](#) I had a few multicolor LEDs laying around and wanted to whip up a color-blending nightlight. I built 2 devices, each in its own 20 pin DIP socket without soldering. A 3-pin header is included so I can reprogram the light on-the-fly if desired. On..... Listed under: [LED Projects](#)
- 
1955.  [automatic power factor controller using microcontroller](#) The 230 V, 50 Hz is step downed using voltage transformer and current transformer is used to extract the waveforms of current. The output of the voltage transformer is proportional to the voltage across the load and output of current transformer is proportional to the..... Listed under: [Microcontroller Programmer Projects](#)
- 
1956.  [LED-Guided Piano Instruction using pic microcontoller](#) [Kay Choe] can't play the piano. Rather, he couldn't, until he converted his keyboard to include LED-guided instruction. [Kay] is a microbial engineering graduate student, and the last thing a grad student can afford is private music lessons. With \$70 in components and a cell..... Listed under: [Sound - Audio Projects](#)
- 
1957.  [PIC16C63 Midi controlled Light dimmer](#) This is Ver2.0 of a finished project. I usually do projects about the same way every time. Product definition (10 min), Code outline (10 min), Schematic generation, Build prototype, Write code all at one sitting (This one took about 6 hours), Take a copy of..... Listed under: [Home Automation Projects, Projects, Sound - Audio Projects](#)

1958.  [Peltier-Powered Drink Cooler!](#) desktop-sized can cooler From the "Something that Should be Made Department" comes this drink cooler. Ever since seeing peltier devices for sale I have wanted to put one to a cool use, and this is it. 😊 The heart of the device is of course..... Listed under: [Home Automation Projects](#)
- 
1959.  [A simple 50 MHz diy microwattmeter using PIC16C84](#) Summary. A design for a simple microwattmeter. Input range -75 dBm to + 5 dBm. Frequency range 2 to 50 MHz. Level resolution is 0.1 dBm, frequency resolution is 10 kHz. Log-output about 0.5 - 3.5 Volt. Output for external counter. The meter uses a..... Listed under: [Metering - Instrument Projects, Projects](#)
- 
1960.  [Bicycle Persistence of Vision Light Display — February 2007](#) In February of 2007 I spent a little while prototyping a board that turns any bicycle wheel into a moving display billboard using a single string of LEDs. The idea was to do something that would be very visible, turn itself on and off automatically,..... Listed under: [Home Automation Projects](#)
- 
1961.  [PICADC – a free, PIC based "intelligent" A/D converter using PIC16F84](#) This is an old design. Some of the components may be difficult to buy. If you would like to build an even better and cheaper A/D converter, take a look at the new PICADC3 design. The PICADC is a simple 12-bit, 8-channel analog to digital..... Listed under: [Interfacing\(USB - RS232 - I2c -ISP\) Projects, Projects, Sensor - Transducer - Detector Projects](#)
- 
1962.  [PIC18F4550 – LCD display.jhd162a \( 2x16\) Interface](#) Project : Display control on a LCD (jhd162a ) Requirements jhd162a LCD PIC18f4550 Here in this project the running display of the screen is been controlled by a PIC18f4550 board which is interfaced to jdh162a lcd. jdh162a lcd is very easily available in any electronic..... Listed under: [LCD Projects](#)
- 
1963.  [C# Software and Firmware, USB INTERFACE BOARD](#) C# Software Application and Firmware for PIC18F4550 Board To continue further with this project you would need to download my version of Firmware to control 6 LED's and a Software application which is written in C# sharp, a project file has been also enclosed with..... Listed under: [Interfacing\(USB - RS232 - I2c -ISP\) Projects](#)
- 
1964.  [Infrared Remote Control with Microcontroller](#) This little project will demonstrate how you can use NEC IR protocol based TV, DVD or VCR remote control to control you home appliances like fan bulb or virtually anything. There are lots of projects out there to accomplish this task but i have to..... Listed under: [Wireless Projects](#)
- 
1965.  [3-Switch Mini IR Remote Control for PIC10F200](#) Description This project is a 3 button mini IR remote control which transmits 12-bit SIRC IR signals as used by Sony remote controls. It has been designed to work with both the 2-channel relay driver board and 3-channel relay driver board projects also on this..... Listed under: [Internet - Ethernet - LAN Projects, Projects](#)
- 
1966.  [Temperature Recorder using PIC12F683 microcontroller](#) Description This project uses a MicrochipPIC microcontroller, a serial EEPROM and a thermistor to create a temperature recorder. Performance The temperature is measured and stored at user programmable intervals; this can be from 1 second to 256 seconds. The time interval is set by programming..... Listed under: [Projects, Temperature Measurement Projects](#)
- 
1967.  [BOOTLOAD THE PIC18F4550 – FIRMWARE UPDATING](#) BOOTLOAD PIC18F4550 – FIRMWARE UPDATING SETTING THE PIC18F4550 IN RD/WR ( BOOTLOAD ) MODE FOR BOOTLOADING Loading / updating new code into the USB INTERFACE BOARD can be done with a Bootloader Software. While searching for good bootloader, I found some nice tutorial on eegeek.net..... Listed under: [Interfacing\(USB - RS232 - I2c -ISP\) Projects](#)
- 
1968.  [USocket – USB controlled Socket with PIC18F4550](#) Introduction The idea of this project is to control (switch off/on) two power sockets with a computer by using its USB port. I've chosen USB in first place because I wanted to experiment with the PIC18F4550 microchip's microcontroller, and secondly because the power supplied by..... Listed under: [Interfacing\(USB - RS232 - I2c -ISP\) Projects, Projects](#)
- 
1969.  [In circuit serial programmer for PIC16F87X](#) Intro Here you can find all resources you need to build your own in-circuit serial PIC16F87X programmer. After experimenting with the PIC16F84, time had come to move on to more powerful devices, such as the PIC16F871. These devices offer a low voltage programming (LVP) mode..... Listed under: [Microcontroller Programmer Projects, Projects](#)
- 
1970. [USB Interface Demo Board Using PIC18F4550](#) PIC18F4550 USB DEMO INTERFACE BOARD PROJECT This project / USB hardware is quiet easy to make at home with few components, this piece of hardware will be detected by your computer like any other external device once it's completed. This is a Simple USB demo..... Listed under: [Interfacing\(USB - RS232 - I2c -ISP\) Projects](#)





1971. [Schaer+ Programmer using PIC12F629 microcontroller](#) Description Schaer is a generic programmer circuit capable of uploading and downloading firmware to/from several electronic devices like microcontrollers and eeproms. This and other programmers came to my attention when I was working in CAMBADA, the robotic soccer team from the University of Aveiro, and since all other..... Listed under: [Microcontroller Programmer Projects](#), [Projects](#)

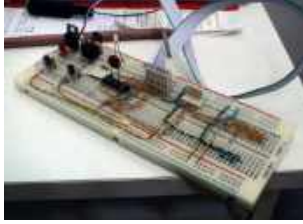

1972. [Stepper Motor Driver using PIC18F4550 Microcontroller](#) Stepper Motor Tutorial In this tutorial we are going to drive a Single unipolar stepper motor using PIC18F4550 Microcontroller in various different stepping modes. The source code and Project files are free to download at the end of this page. Stepper motor due its excellent..... Listed under: [Motor Projects](#)



1973. [A modified version of the "Air display" adapted to be used in a bicycle using PIC12F629 microcontroller](#) Anthony from Cumaná, Venezuela, made his own "Persistence of vision" (POV) display, similar to my Air Display but it can be mounted on any bicycle wheels and it displays fifteen messages in Spanish. Here is the PCB with each part of the project. It uses..... Listed under: [Other Projects](#), [Projects](#)

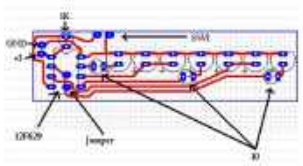

1974. [PIC18F4550 Tutorial: Blink LED – 2](#) Hi welcome to my 4th chapter of PIC18F4550 programming. Here we are going to learn another methodology or technique for programming a pic18f microcontroller which would be helpful in future while dealing with complex coding. We are going to define our own header file. We..... Listed under: [LED Projects](#)



1975. [PIC18F4550 Tutorial: Blinking an LED](#) TUTORIALS PIC18F4550 Programming Tutorial in Hardware C PIC Tutorial, Mplab IDE - C18 compiler toolsuite PIC18F4550, Looking the data sheet | Ports PIC18F4550 Programming Blink led method 1 PIC18F4550 programming Method 2 Blink led PIC18F4550 Blink LED 20MHZ Oscillator | XC8 Mplab X IDE and..... Listed under: [LED Projects](#)

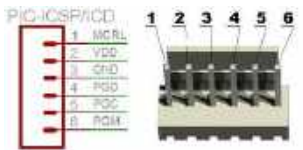

1976. [Using Fixed Voltage Reference \(FVR\) for A/D conversion in enhanced mid-range PIC microcontrollers](#) The reference voltage plays a very important role in any A/D conversion. It determines both the range and the resolution (Volt/Count) of the A/D conversion. Besides, the accuracy of the conversion also depends upon how stable the reference voltage is. Usually in PIC microcontrollers, the..... Listed under: [LED Projects](#)



1977. [MEASURING HEART RATE USING A PHOTOPLETHYSMOGRAPHIC CARDIOTACHOMETER using pic-microcontroller](#) ABSTRACT The heart rate is an important measure of health and physical fitness. Medical professionals rely heavily on the rate as a measure of health status and use it to prescribe treatment to individuals. Athletes value the heart rate highly as a tool for regulating..... Listed under: [Medical - Health based Projects](#)

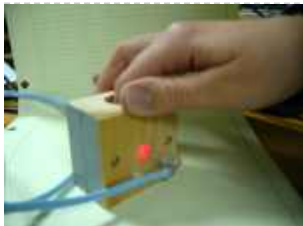

1978. [4 Channel DMX512 Driver for PIC16F688](#) Description This project is a 4 channel DMX512 driver board. It features four power MOSFETs that can be configured to operate in PWM mode or as on/off outputs. The driver can be configured to use any four consecutive addresses across the full 512 channel address..... Listed under: [Development Board - Kits Projects](#)

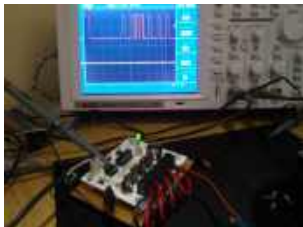

1979. [Frankenbear Synthamajig using PIC16F877 microcontroller](#) Frankenbear Synthamajig Have you ever wanted a teddy bear that looks like Frankenstein and makes sounds like "bleep bleep blooop de de bleep.... EHHHHHHHHHH..... dadadadadadadododododod bleep bleep bloop"? Look no farther, you have found it! Now you can perform the nights away with your new..... Listed under: [Game - Entertainment Projects](#), [Projects](#)



1980. [Daft Punk Table Replica Graphics Controller using PIC18f2550](#) Daft Punk Table Replica Graphics Controller This instructable presents a graphics controller card for something like the Daft Punk Table Replica. This should be used in conjunction with a driver board (output expander) like this one, which will drive the high loads presented by the..... Listed under: [Other Projects](#), [Projects](#)













1981. [Interface single and Dual IR Infrared sensor with PIC18F4550 and LCD](#) In this another tutorial on sensors for beginners, we are going to interface single and multiple Infrared IR sensors with Arduino Uno development board, working simultaneously and have the status displayed either on an ( 4X16 LCD ) LCD module (jhd162a) or an LED. We..... Listed under: [Interfacing\(USB - RS232 - I2c -ISP\) Projects](#), [LCD Projects](#), [Sensor - Transducer - Detector Projects](#)

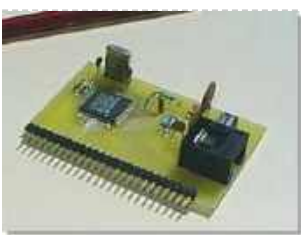

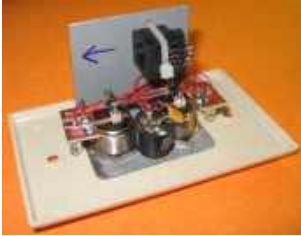



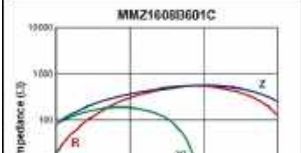



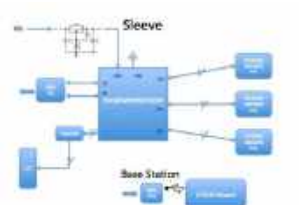

1982. [Very Accurate LC Meter based on PIC16F628A using pic microcontroller](#) Accurate LC Meter Part's List: 1x 16x2 LCD Display with Green / Blue Backlight 1x PIC16F628A Programmed Microcontroller 1x LM311 IC 1x Accurate LC Meter PCB with red solder mask 1x Enclosure 1x Gold Plated Machined 18 DIP IC Socket 1x Gold Plated Machined 8..... Listed under: [Metering - Instrument Projects](#)



1983.  [USB Interface Board Driver Installation PIC18F4550](#) USB Interface Board Driver Installation Connecting PIC18F4550 First Time This tutorial will try to explain how to make your interface development board to work for the first time. Without a Demo hex code inside PIC18F4550's flash memory, it won't respond even if we connect the..... Listed under: [Interfacing\(USB - RS232 - I2c -ISP\) Projects](#)
1984.  [PIC16F877 based controllable digital clock using LCD display \(Code+Proteus simulation\)](#) This PIC16F877 microcontroller tutorial answers the question, " How to implement a controllable digital clock using PIC16F877 ? " Using PIC16 simulator (Proteus) you can verify this digital clock code and change it according to your needs. Using three push buttons (As shown in figure..... Listed under: [Clock and Timer Projects](#), [LCD Projects](#)
1985.  [Infrared \(IR\) Object Detection Module Circuit Using IR LED and Photodiode](#) How to make Infrared (IR) sensor Object Detection Module Circuit Using IR LED and Photodiode The IR Object Detection sensor module is quiet easy to make. This sensor circuit below is a low cost - low range infrared object detection module that you can easily..... Listed under: [LED Projects](#)
1986.  [Experimenter's board for enhanced mid-range PIC microcontrollers \(PIC16F1827 and PIC16F1847\)](#) The PIC16F628A has always been my first choice for microcontroller-based projects. It is simple, inexpensive, and easily available. Due to its compact size (18 pins) it occupies lesser space on the circuit board, and meanwhile, it is powerful enough to serve most of a hobbyist's..... Listed under: [Development Board - Kits Projects](#), [Projects](#)
1987.  [PIC16C74 Embedded 10BaseT Ethernet CS8900](#) Embedded ethernet enables microcontroller based projects to send and receive packets over the network. The board shown on the left is actual size and incorporates all the circuitry needed to enable 10BaseT communications. The board is designed to minimize the pin count needed to interface..... Listed under: [Internet - Ethernet - LAN Projects](#)
1988.  [Introduction to the PIC32 using pic-microcontroller](#) The Microchip PIC32 is a family of complex and powerful microcontrollers that can be purchased for less than \$10 in quantities of one. This microcontroller offers many peripherals useful for mechatronics purposes, such as several channels for analog-to-digital conversion, digital I/O, synchronous and asynchronous serial..... Listed under: [Video - Camera - Imaging Projects](#)
1989.  [STEAM GENERATOR using PIC16F873](#) Introduction This program is a steam generator controller that is intended for use in a residential steam shower. It controls water inlet and drain valves, power to the heating element, and various level and thermal sensors. Features Push button automated control of the steam shower..... Listed under: [Home Automation Projects](#), [Projects](#)
1990.  [Building the Mongoose Mechatronics Robot: Part 1 Chassis & Gearbox using PIC18F2525](#) Building the Mongoose Mechatronics Robot: Part 1 Chassis & Gearbox This is the first of a series of illustrated instructions for assembling the Mongoose Robot kit available from bluroomelectronics Mongoose highlights: Powerful PIC18F2525 microcontroller (32KHz to 32MHz) Hardware PWM controlled SN754410 H-Bridge with thermal shutdown..... Listed under: [Projects](#), [Robotics - Automation Projects](#)
1991.  [Open Automaton Project](#) The objective is to use readily available "off-the-shelf" low-cost consumer components where possible, and to design electronic subsystems where such components are either not readily available or are too expensive. In terms of affordability, the overall goal is to design a robot that can be..... Listed under: [Robotics - Automation Projects](#)
1992.  [RGB LED PWM Driver for High Power 350mA LEDs V3 using PIC12F629](#) Description As featured in Electronics Weekly Gadget Freak (20/02/2008) The main reason I made this version is that I wanted to fit it in to the base of an Ikea Mylonit lamp. This lamp is made entirely from glass and has a small recess in..... Listed under: [LED Projects](#), [Projects](#), [PWM Projects](#)
1993.  [LED fireflies prototype using PIC12f683 microcontroller](#) LED fireflies prototype hello all, heres an attempt i made at something like an LED throwie..the problem (for me) with led throwies is that they just consume their battery, and produce light.. but they could be better at doing both.. first you have to accept..... Listed under: [LED Projects](#), [Projects](#)
1994.  [PIC'ing the MAX5581: Interfacing a PIC Microcontroller with the MAX5581 Fast-Settling DAC](#) MAX5581 Overview The MAX5581 is a 12-bit, fast-settling DAC featuring a 3-wire SPI™ serial interface. The MAX5581's interface can support SPI up to 20MHz with a maximum settling time of 3μs. This application note presents an application circuit and all the firmware required to interface..... Listed under: [Interfacing\(USB - RS232 - I2c -ISP\) Projects](#)



1995.  [IR\(infrared\) Remote Control Relay Board with PIC 12F675 Microcontroller](#) Introduction This little project will demonstrate how you can use your old NEC IR protocol based TV,DVD or VCR remote control to control you home appliances like fan bulb or virtually anything. Consumer IR protocols There are a number of consumer Infrared protocols out there and they have..... Listed under: [Home Automation Projects](#)
- 
1996.  [Programmable watch with four character display using PIC16F628A microcontroller](#) Programmable watch with four character display You'll be the talk of the town when you wear this obnoxious, oversized, completely impractical wristwatch. Display your favourite foul language, song lyrics, prime numbers, etc. Inspired by the Microreader kit, I decided to make a giant watch using..... Listed under: [LED Projects](#), [Microcontroller Programmer Projects](#), [Projects](#)
- 
1997.  [Throbbing Apple Logo Sticker using PIC10F206 microcontroller](#) Throbbing Apple Logo Sticker This little gizmo adds the iconic "sleeping Mac throb" to an ordinary Apple logo decal. The idea for this came about when passing by the Apple Store in Palo Alto, California late one night. After hours, when the store is "asleep," ..... Listed under: [Battery Projects](#), [LED Projects](#), [PWM Projects](#)
- 
1998.  [Augustus's Lab Notebook using pic microcontoller](#) Week 01 January 10, 2012 (1 hour): Met as a team after class to discuss preliminary project proposal. January 12, 2012 (2 hours): Met as a team after class to finish writing preliminary project proposal. WEEK 01 SUMMARY Accomplishments: Submitted preliminary project proposal. Weekly Work..... Listed under: [LCD Projects](#)
- 
1999.  [Top 5 Wireless Ways to Communicate with your Controller](#) One of the strongest trend we have seen this year at CES2015 is, as you can imagine easily, the IoT (Internet of Things) development. Consequently, the most important component needed is the "connection and communication" module that enables the remote interaction between the device and..... Listed under: [Wireless Projects](#)
- 
2000.  [DCF77 clock-thermostat using PIC16F648A](#) Always at the right time your house on temperature This project make use of a PIC16F648(A) and a DCF77 receiver from Conrad (Orderno. 64 11 38) With DCF77 runs the clock from the thermostat always on the right time. Synchronizing isn't necessary anymore. The temperaturesensor is a DS1820..... Listed under: [Clock and Timer Projects](#), [Temperature Measurement Projects](#)
- 
2001.  [Nike+iPod reverse engineering \(protocol too\) using pic microcontroller](#) UPDATE: code posted below Nike+iPod is a very interesting piece of hardware for all kinds of reasons, not the least of which is that it as actually useful. It works by wirelessly transmitting data from a sensor (that is stored in your shoe) to a..... Listed under: [Sensor - Transducer - Detector Projects](#)
- 
2002.  [Misc Projects : High Power RGB LED Controller](#) This is an ongoing project to control a number (currently 5) of Lamina Atlas high power (350-500mA) LEDs. Current progress includes: PCB artwork (in Eagle) with connections for 5 RGB LEDs. Firmware for a Microchip PIC16f887 microcontroller to interface between the FTDI 245R USB chip..... Listed under: [LED Projects](#)
- 
2003.  [Ways you can use the DDS Daughtercard](#) How many ways can you use a self-contained, high-precision signal source contained on a 1" x 2" plug-in circuit card? How about as a stand-alone VFO, a signal generator for your bench, a replacement LO for your Sierra or NC40 transceiver, or perhaps as the..... Listed under: [Interfacing\(USB - RS232 - I2c - ISP\) Projects](#)
- 
2004.  [A Word Clock using PIC16F877 microcontroller](#) A Word Clock  
\*\*\*\*\* Major updates - A much better enclosure for this clock has been designed, and a better controller using an AtMega controller now exists. check out <http://www.instructables.com/id/The-Wordclock-Grew-Up/>  
\*\*\*\*\* This is a project to tell the time using words. I saw a cool..... Listed under: [Clock and Timer Projects](#)
- 
2005.  [DC motor control with Joystick and PIC16F877A](#) This is one project that i'm doing, now I'm going to show how to do it only for one motor, but i'm using and DEMUX to in the future use 4 motor. The project is simple, it uses the pic to control the DEMUX and..... Listed under: [Motor Projects](#)
- 
2006. [Dialing Alarm using PIC16F628 Microcontroller](#) This is the lowest-cost dialing alarm on the market and shows what can be done with a PIC microcontroller. The complete circuit is shown below. You cannot see all the features of this project by looking at the circuit - most of them are contained in the..... Listed under: [Projects](#), [Security - Safety Projects](#)



2007.



[Whac-a-Veggie using PIC18F4550 microcontroller](#) Whac-a-Veggie For this year's Trunk 'O' Treat game I wanted to make a something fun and exciting for kids to play so I choose a Whac- a-Mole type game called Whac-a-Veggie using the Veggie Tales characters. The Whac-a-Veggie game is played with a foam..... Listed under: [Development Board - Kits Projects](#), [Game - Entertainment Projects](#), [Projects](#)

2008.

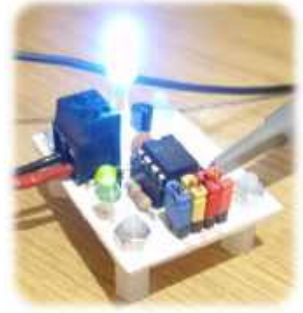

[LED Strobe for PIC12F629 / 675](#) Description This project functions as a simple strobe for driving an LED. The use of an output transistor allows it to pulse the strobe LED with a current up to 100mA. Four jumpers provide options for changing the pulse width, strobe repeat interval and single..... Listed under: [LED Projects](#)

2009.



[IRMimic™ Trainable IR Remote Control Transmitter using pic microcontoller](#) IRMimic features: Simple to train - Can learn up to 16 IR commands, and each can be in a different format/protocol Two different operating modes - Keypad or MCU interface LED indicator output - Indicates training is complete Small size - 18 pin DIP IC..... Listed under: [Other Projects](#)

2010.

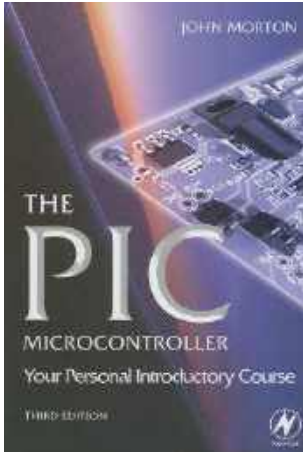

[PIC16F84 Introduction](#) The 16F84 is deserves looking at because it is the GrandDaddy of PIC Microcontrollers but you should not use it for new designs (see Below)... The PIC16F84 is the most well known and most well used of all the PIC microcontrollers - it is used..... Listed under: [Microcontroller Programmer Projects](#)

2011.



[USB Voltmeter using pic microcontoller](#) USB Voltmeter USB Voltmeter is a PC based dual channel voltmeter built around PIC18F2455 / PIC18F2550 microcontroller that measures voltage from 0.00V up to 500.00V with 10mV resolution. USB Voltmeter sends measured data to PC via standard USB connection displaying data on a computer monitor..... Listed under: [Interfacing\(USB - RS232 - I2c -ISP\) Projects](#), [Metering - Instrument Projects](#)

2012.

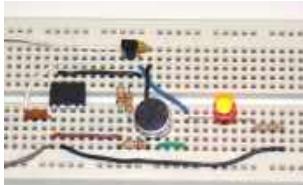

[Microcontroller with single LED Project in Proteus](#) This is a simulation project that shows how to write program in assembly language for PIC16F84A microcontroller that turns on a single LED and use it in Proteus VSM to stimulate the working of the microcontroller controlled LED. To do this start by creating a..... Listed under: [LED Projects](#)

2013.



[Low cost OLED module interface using PIC18F452](#) Here are the technical specifications: OLED resolution: 96 x 64 pixels OLED manufacturer: OSRAM. OLED model: Pictiva 1.1 inch OS096064PN11MY0B10 (San Diego.) On-board lcd controller SSD1303, with 31 pins connector, can be soldered directly. Low power operation (less than 15-25mA @3V, depending on contrast/brightness setting)..... Listed under: [Interfacing\(USB - RS232 - I2c -ISP\) Projects](#), [LED Projects](#), [Projects](#)

2014.









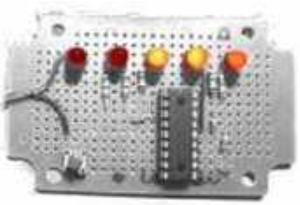

[A remote controlled power RGB LED mood light using PIC16F627A](#) A remote controlled power RGB LED mood light. Control the colour of a powerful LED light beam with a remote control, store the colours and recall them at will. With this thing I can control the colour of a bright light into many different colours..... Listed under: [Game - Entertainment Projects](#), [Home Automation Projects](#), [LED Projects](#), [Projects](#)

2015.

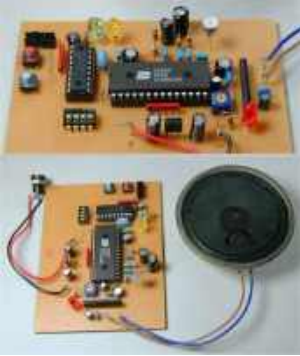

[DIY plug-in modules to make microcontroller breadboarding easier](#) Breadboards are a great tool for prototyping and testing electronics circuits. Here I am sharing with you some plug-in modules that I once made to make my breadboarding life easier. I have used these modules many times in the PIC experiments described in this blog..... Listed under: [Development Board - Kits Projects](#)

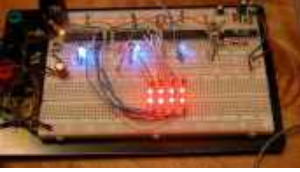
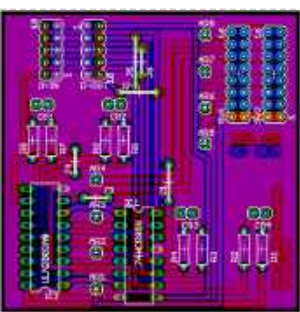

2016.  [Mini F1 race track Grid Start Lights using PIC12F627A](#) (See big LED version here) My nephews got a Scalextric slot car racing circuit from Santa for Christmas. This was a blast-from-the-past for my brother and me and we were soon showing the kids how to race. However it quickly became apparent that "3-2-1-Go" wasn't..... Listed under: [Game - Entertainment Projects](#), [Projects](#)
- 
2017.  [True USB GQ-4X Programmer using pic microcontroller](#) <http://www.bubblesoftonline.com/pocket/pocket.html> {ed: Tony moved on, the web site is closed, but all the files are here: pocket.zip file containing all the files required to build the kit, install the Win32 application, setup the unit, and program chips. Also includes source code. This will extract to..... Listed under: [Microcontroller Programmer Projects](#)
- 
2018.  [ISD2560 Voice Recording Playback Project PIC16F84 Controlled](#) ISD2560 to directly control the PIC16F84A, audio recordings and multiple block will be able to play. LSI can be driven directly speakers also, in view of the lack of volume, only added to the amplifier IC. This volume 10 minutes to drive the speakers. One..... Listed under: [Sound - Audio Projects](#)
- 
2019.  [Aurora 48 – 48 RGB LED Sequencer](#) Aurora 48 is a compact and thin profile full-color LED sequencer. It's built entirely with surface mount components, so the profile is nice and clean. Step 1: Features Capable of individually controlling 48 Full color LEDs. Each LED can be faded in 7 bit per channel - 2,097,152..... Listed under: [LED Projects](#)
- 
2020.  [PIC Industrial and Domestic Timer \(Relay Controller\)](#) Hi Friends, I hope everyone had a rocking New year I was suppose to give you all a New year gift uploading a new project, but unfortunately it got delayed 'coz I was busy with my \*personal life\* One of our site member, Jeswanth kumar..... Listed under: [Clock and Timer Projects](#)
- 
2021.  [Contactless Digital Tachometer using PIC Microcontroller](#) Hey friends, I should have posted this project last month itself but there was some problem with the circuit. [link], author of this project did an excellent job. I have been watching him learning on this website. He came as a total noob but now..... Listed under: [Security - Safety Projects](#)
- 
2022.  [Rotary dialer PIC interface using PIC16F877](#) Rotary dialer PIC interface I have found myself with an abundance of rotary phones. In fact, they're everywhere I look. In hopes that I may someday see less of them, I've begun taking them apart and re-using the parts for other purposes. For some reason..... Listed under: [Interfacing\(USB - RS232 - I2c -ISP\) Projects](#), [Phone Projects](#), [Projects](#)
- 
2023.  [LED Sensors](#) Things are moving along ... With my new understanding of I2C master/slave communications, I've started work on larger arrays and finding the best way to manage the array and communicate the data to the host PC. Above is the latest iteration of the project... and..... Listed under: [LED Projects](#), [Sensor - Transducer - Detector Projects](#)
- 
2024.  [Iron in the Fire II](#) In my previous post, I write about an LED matrix for a marquee. The display itself is a two-board solution, the second board or 'daughterboard' piggy-backs on some pin headers from the display board. This second PCB provides the control interface and logic for handling..... Listed under: [Battery Projects](#)
- 
2025.  [How to interpret the direction of rotation from a digital rotary switch with a PIC using PIC16F877A](#) How to interpret the direction of rotation from a digital rotary switch with a PIC The objective for this Instructable is to illustrate how to interface a digital (quadrature coded) rotary switch with a microcontroller. Don't worry, I'll explain what □quadrature coded□ means for us..... Listed under: [How To - DIY - Projects](#), [Projects](#)
- 
2026.  [Water Filter Controller](#) As a fan of taking my dihydrogen monoxide in straight, uncut, uncorrupted liquid form, I purchased a six stage reverse osmosis filter some years ago. My filter is a few years old now, and the super calcium enriched water we have in Michigan has taken..... Listed under: [Home Automation Projects](#)
- 
2027. [Interfacing with The Energy Detective using pic microcontoller](#) I recently bought The Energy Detective (TED), a pretty inexpensive and friendly way to keep tabs on your whole house's electricity usage. It's a lot like having a more featureful version of your utility company's power meter, sitting on your kitchen counter. It can estimate..... Listed under: [Interfacing\(USB - RS232 - I2c -ISP\) Projects](#)

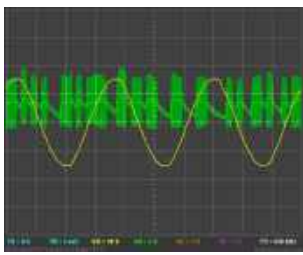

2028.



[PIC Controlled Relay Driver using pic microcontroller](#) We love to read emails from our visitors, Please let us know by clicking here if you find any kind of bug/error in our site. We will fix it as soon as possible. PIC Controlled Relay Driver This circuit is a relay driver that is..... Listed under: [Other Projects](#)

2029.

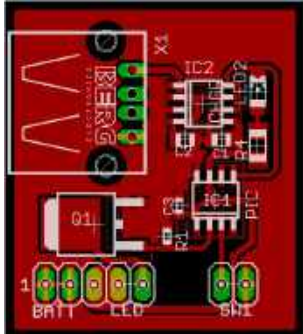

[MintLite Part I](#) MintLite – The Luxeon Powered Mint Tin Flashlight! This idea has been rattling around in my head for more than a month now, and I finally have thought it out enough to do some doodling in Eagle. The basic idea is built around a six..... Listed under: [Home Automation Projects](#)

2030.

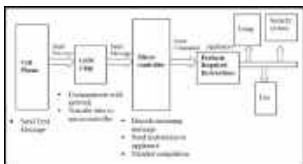

[GSM based Control System by pic microcontroller](#) GSM based Control System by pic microcontroller implements the emerging applications of the GSM Technology. Using GSM networks, a control system has been proposed that will act as an embedded system which can monitor and control appliances and other devices locally using built-in input and..... Listed under: [Internet - Ethernet - LAN Projects](#)

2031.



[Interfacing of PIC16F84A with \(i2c based\) 24LC64 EEPROM \(Code + Proteus simulation\)](#) This post provides the code for interfacing 24LC64 EEPROM with PIC16F84A microcontroller. This 24LC64 EEPROM has i2c based interface and PIC16F84A doesn't have any built in i2c modules, so software i2c module is created in the code. This code is written in C language using MPLAB with HI-TECH..... Listed under: [Interfacing\(USB - RS232 - I2c -ISP\) Projects](#), [Memory - Storage Projects](#), [Projects](#)

2032.



[LED Matrix Backpack](#) I had purchased some huge (2") 5x7 matrix a while ago, as part of my led sensor research. They've basically been banging around the lab since, getting pins bent and such. So this past weekend, I decided to put them to some other use. Their..... Listed under: [LED Projects](#)

2033.



[New Earth Time digital clock in recycled retro-modern case using PIC16F627A](#) New Earth Time (NET) digital clock in recycled retro-modern case Ever get confused by GMT, or just wish you had a cooler way to keep track of time? Build a New Earth Time clock! Using a PIC microcontroller, some code, and a couple discrete parts,..... Listed under: [Clock and Timer Projects](#)

2034.



[Reading Nintendo 64 controller with PIC microcontroller](#) I have a few old N64 controllers lying around and figured that it would be pretty cool to use them to control other things. In this article I will describe in detail every step I took to achieve this. I've used a PIC microcontroller, but..... Listed under: [Interfacing\(USB - RS232 - I2c -ISP\) Projects](#)

2035.



[Prometheus/Pandora's Box using PIC12C508 microcontroller](#) Prometheus/Pandora's Box Some of you monkeys out there think you can PWN me. You need to be Spanked. Here is an obfuscated ultraminimalized Monolith for you. It is enlightening and harmless, except to the devil, who really hates it, because I'm letting you have it..... Listed under: [Other Projects](#), [Projects](#), [Radio Projects](#)

2036.



[A Real Time Clock IC \(DS1307\) project using the PIC micro.](#) Making A Real Time Clock (RTC) is simple if you use a helper chip such as a DS1307 because you do not need to keep track of the length of each month or account for leap years. It is all done for you, plus you..... Listed under: [Clock and Timer Projects](#)

2037.

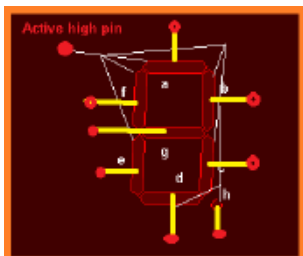

[Interfacing 7 segment display with pic16f877 microcontroller](#) This post will describe that how easily we can do Interfacing 7 segment display with pic16f877 microcontroller. 7 segment display is a basically array of 7 leds with some proper arrangement. From this fig it can be seen that 7 leds arranged with an array..... Listed under: [LED Projects](#)

2038.

[Implementation USB into microcontroller: IgorPlug-USB \(AVR\) using pic microcontroller](#) [advanced\_iframe securitykey="7053122eaa09ce46830dfb8aaeae454056003ad0"]Purpose of this article is to inform readers about implementation USB interface





into singlechip microcontroller, which this interface directly not supports. Simply: implementation USB interface on firmware level (similar as emulation of RS232 interface in microcontrollers, which not have RS232 support). This project includes..... Listed under: [Interfacing\(USB - RS232 - I2c -ISP\) Projects](#)

2039.



[RS232 Communication with PIC Microcontroller](#) Description This article shows how to do a simple communication via a RS232 interface with a PIC microcontroller. RS232 is a standard for a serial communication interface which allows to send and receive data via at least three wires. With the RS232 interface it is..... Listed under: [Interfacing\(USB - RS232 - I2c -ISP\) Projects](#)

2040.



[The Trickster – USB Computer Prank using PIC18F14K50](#) The Trickster - USB Computer Prank Plug The Trickster into your victim's computer, and it will randomly move their mouse while playing a game or using the desktop; Compatible with all operating systems Harmless fun: Acts as a second mouse, and goes away when you..... Listed under: [Game - Entertainment Projects](#), [Interfacing\(USB - RS232 - I2c -ISP\) Projects](#), [Projects](#)

2041.



[Four way traffic light signal using PIC16F84A microcontroller:](#) Hi friends, today we are going to make a four way traffic light controller using a PIC16F84 microcontroller. In this project we will operate three LEDs (RED, YELLOW, and GREEN) according to the traffic rules. Illumination of the green light allows traffic to proceed in..... Listed under: [LED Projects](#)

2042.



[How to adapt a NES clone controller to bluetooth using PIC12F675](#) How to adapt a NES clone controller to bluetooth I bought a Wireless Bluetooth RS232 TTL Transceiver Module from DX (SKU 80711) and wonder what i can do with it. So, I'm really nostalgic and decided to build a NES clone controller to bluetooth adapter,..... Listed under: [Internet - Ethernet - LAN Projects](#), [Projects](#)

2043.



[PIC16F877 ISA Ethernet Web Server Project](#) The PIC16F877 microcontroller, prepared with activated an old ISA ethernet (3com ether Link) Used guess PIC internet connection with an application I'm not sure circuit aim could not understand the pic programming dealing with people who can solve resource assembly asm PCBs (eagle) control program..... Listed under: [Internet - Ethernet - LAN Projects](#)

2044.



[One PIC Microcontroller Platform Development Board](#) One PIC Microcontroller Platform Development Board Develop firmware using Microchip's 8/16/32-bit PIC® Microcontrollers all on one board! Each device comes preprogrammed with firmware to operate the LCD, LED and capacitive touch pads. In addition to three PIC® Microcontrollers, this board also has a dedicated..... Listed under: [Development Board - Kits Projects](#)

2045.

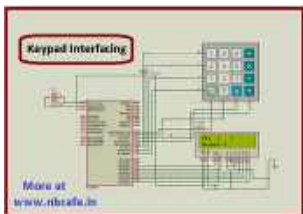

[Keypad scanning and interfacing with PIC16f877 microcontroller](#) Here I give you very important and simple project on Keypad / keyboard scanning and interfacing with PIC16f877microcontroller . To start big project you need to know small and necessary one first. So we start form basic . In my previous post I write on Scrolling..... Listed under: [Security - Safety Projects](#)

2046.



["Mini-Beacon" miniature programmable LED Flasher that is based around a PIC12F629 microcontroller](#) This project, called "Mini-Beacon", is a miniature programmable LED Flasher that is based around the PIC microcontroller. This project grew out of an idea and recommendation posted on RunRyder.com. The Mini-Beacon basically simulates the light emitted from a rotating light beacon such as those used in older..... Listed under: [LED Projects](#)

2047.



[Teddy nightlight multicolor using PIC16F84A microcontroller](#) Teddy nightlight multicolor A nice night light multicolor, ideal for baby's room. For the realization I used: - Out of a pack of bubble bath for children in the shape of teddy bear - a nightlight with positive economic pressure - Complete circuit with a..... Listed under: [Game - Entertainment Projects](#), [Home Automation Projects](#), [LED Projects](#), [Projects](#)

2048.



[DIGITAL CLOCK CIRCUITS](#) A Digital Clock can be made easily by using PIC Microcontroller, DS1307 and a 16\*2 LCD. I have already posted about Interfacing DS1307 RTC with PIC Microcontroller. The DS1307 RTC can work either in 24-hour mode or 12-hour mode with AM/PM indicator. It automatically adjusts..... Listed under: [Clock and Timer Projects](#)

2049.

[Project on making calculator using PIC16F877 and Mikro C Pro](#) Here I give you tutorial of Project on making calculator using PIC16F877 and Mikro C Pro. After go through this project and learn the technique you can implement in your project. In my previous post I show you how to interface keypad 4 x 4 matrix's ..... Listed under: [Calculator Projects](#)

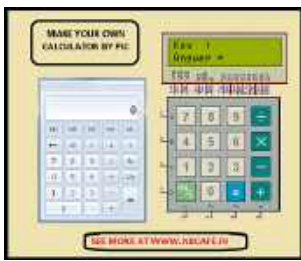

2050. [Interfacing of PIC16F84A with DS1307 \(RTC\) code and Proteus simulation](#) This post provides the code for interfacing DS1307 RTC with PIC16F84A microcontroller. This DS1307 RTC has i2c based interface and PIC16F84A doesn't have any built in i2c modules, so software i2c module is created in the code. This code is written in C language using MPLAB with HI-TECH C compiler. You..... Listed under: [Interfacing\(USB - RS232 - I2c -ISP\) Projects, Projects](#)

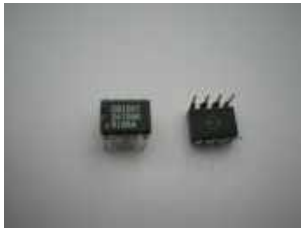

2051. [POV Toy](#) I recently had the urge to create some "eye candy"; Thinking along the lines of my LED Sign (it's not dead, just waiting on parts!), I chose to create a similar effect, using only a single line of leds, instead of a 5x7 array. Persistence..... Listed under: [Game - Entertainment Projects](#)



2052. [Aurora 9x18 RGB LED art using PIC24F08KA101 microcontroller](#) Aurora 9x18 RGB LED art \*\*\* Check out my blog for updated version of this project and more! \*\*\* My obsession of LEDs has led me to this. Aurora 9x18 is a thing of beauty (if I can say so myself) - has 162 RGB-LEDs..... Listed under: [LED Projects, Projects, PWM Projects](#)

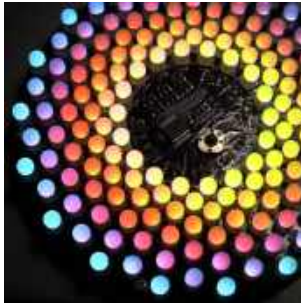

2053. [PIC16C54 dual dice electronic project circuit](#) An electronic dice project circuit can be designed in various modes , using logic circuit or using microcontrollers . This electronic project is based on the PIC16C54 microcontroller , manufactured by Microchip . This project is a simple dual dice electronic project , that use few external electronic parts..... Listed under: [Development Board - Kits Projects](#)



2054. [A pic programmer circuit based on AN589. using pic microcontoller](#) AN589 is microchip's application note for a parallel port pic programmer circuit which I chose as I wanted something reliable to get up and running quickly. It is really quite a simple circuit and its main objective is to provide ICSP connections to your pic..... Listed under: [Microcontroller Programmer Projects](#)



2055. [High res cap meter with PIC 16F628](#) High resolution capacitance meter measures in 0.01pF digits. Total range 0pF to 50uF. - 27th Jun 2011, Updated 25th may 2013. Another PIC based capacitance meter? Although there are a few PIC based "pico" capacitance meters on the internet this design has some advantages over..... Listed under: [Metering - Instrument Projects](#)



2056. [Time Display unit for a GPS module using pic microcontroller](#) I decided to build a device to permanently display accurate time received from a cheap GPS module installed in my workshop. Having obtained a PIC18F1320 microcontroller for experimentation, I wanted to learn about the new features of the PIC18F range using only minimal hardware to..... Listed under: [Clock and Timer Projects, GPS Based Projects](#)



2057. [Sine Triangle Square Saw Burst Sweep Noise – runs on a PIC16F870](#) After the recent demise of our multifunction signal generator, we decided to make one of our own. The circuit uses a PIC16F870 (about \$3), an R/2R resistor ladder network (for a real fast and cheap D/A), and a few other parts. You can check out..... Listed under: [Metering - Instrument Projects](#)

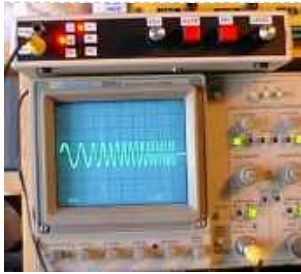

2058. [Object Detecting Android Mobile Phone Controlled Bluetooth Robot Using PIC Microcontroller 16F877A](#) Last time we had a project on Arduino robots with Bluetooth and Android, and in that one our readers Mr. Paul asked how he can make an obstacle avoidance robot. So today I came up with another engineering project for electronics and communication students, Android and..... Listed under: [Bluetooth Projects, Robotics - Automation Projects](#)



2059. [Computer controlled infrared transmitter based on PIC](#) description This is a programmable infrared (remote control) transmitter, which can be controlled from a computer serial port. It is capable of sending many remote control formats, including the Philips RC-5 standard. Exact formats with the timing parameter names are shown on the pictures: operation..... Listed under: [Metering - Instrument Projects](#)

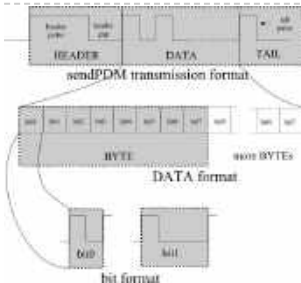

2060. [Ways to Select a Best Microcontroller for Microcontroller based Projects](#) Do you know how to select the best microcontroller for microcontroller based projects? Selecting the proper microcontroller for a given application is one of the most critical decisions, which controls the success or failure of the task. There are different types of microcontrollers available and..... Listed under: [Memory - Storage Projects](#)



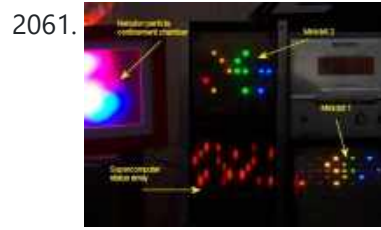

2061. [Minidot 2 – The holoclock using PIC16F88 microcontroller](#) Minidot 2 - The holoclock Well maybe holoclock is a little bit inaccurate....it does use holographic dispersion film on the front to give a bit of depth. Basicly this instructable is an update to my previous Minidot located here: <http://www.instructables.com/id/EEGLXQCSKIEP2876EE/> and re-using a lot of..... Listed under: [Game - Entertainment Projects](#), [Projects](#)



2062. [embedded microchip](#) Microchip Technology Inc. is a Leading Provider of Microcontroller and . (Nasdaq: MCHP) Manufactures and markets a variety of VLSI CMOS semiconductor components to support the embedded control market.[www.microchip.com](http://www.microchip.com) - 143k - CachedMicroch Microchip Technology Inc. is a Leading Provider of Microcontroller and . (Nasdaq:..... Listed under: [Other Projects](#)



2063. [Robot 1: "Little Jimmy" based on PICAXE-18M2](#) Robot 1: "Little Jimmy" based on PICAXE-18M2 I wanted to build this little robot to give me a fun and flexible platform for learning more about programming, RC (radio-control), drive trains (the mechanics that make it go) and the newest PICAXE processor, the 18M2. Under..... Listed under: [Projects](#), [Robotics - Automation Projects](#)



2064. [USB PIC Programmer : PICKit2 using pic microcontoller](#) Microchip's PICKit2 is much more comfortable, reliable and powerful than the other programmers that we can find all over internet. It is a USB based ICSP (In Circuit Serial Programming) programmer. Since it is a first release, Microchip published all the resources of PICKit2 public, which includes hardware..... Listed under: [Interfacing\(USB - RS232 - I2c -ISP\) Projects](#)

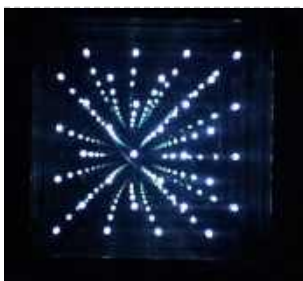

2065. [8x8 LED Array Multiplexed Infinity Mirror using PIC18F1320](#) 8x8 LED Array Multiplexed Infinity Mirror A little bit different than your regular Infinity Mirror. Using a piece of mirrored acrylic for the back mirror, 8 rows of 8 holes are drilled into in a grid pattern. A LED is then placed in each hole..... Listed under: [LED Projects](#), [Projects](#)



2066. [picLink RS232 low cost development controller with ADC using PIC16F628A](#) PicLink RS232 low cost development controller with ADC PICLink RS232 Embedded Controller The PICLink RS232 controller module affords any microcontroller enthusiast an easy to construct mini-microcontroller module. This embedded microcontroller is ICSP (in circuit serial) programmable and provides separate PORTA, PORTB, RS232 I/O ports, 4..... Listed under: [Other Projects](#), [Projects](#)



2067. [DC Motor Control using Temperature Sensor & 8051 Microcontroller](#) Microcontroller are widely used in electronics gadget and are one of the key element in developing any project and thus this project used 8051 microcontroller and will help in teaching about interfacing of temperature sensor with ATMEL microcontroller by means of ADC, to display the..... Listed under: [Motor Projects](#), [Sensor - Transducer - Detector Projects](#)

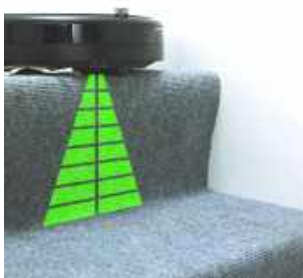



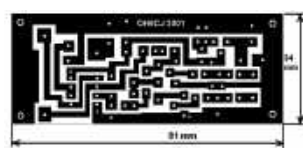



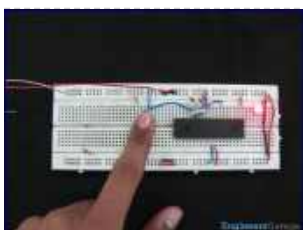



2068. [Small Virtual Wall for iRobot Roomba using PIC12F629](#) The Virtual Wallis a circuit to mimic the behaviour of the iRobot Virtual Wall/Lighthouse, provided with the robot. It produces the same infrared pattern and the robot sees it as another virtual wall, blocking its path, while vacuuming. This circuit was built mostly using SMD..... Listed under: [Projects](#), [Robotics - Automation Projects](#)

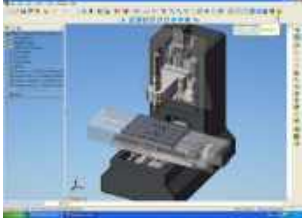
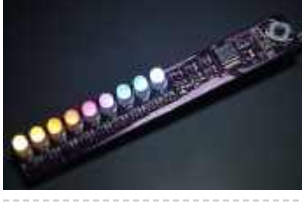

2069. [PIC Frequency Counter with Frequency Lock function](#) Table of Content: Frequency Reference Frequency Actual Subtraction and Comparator Digital Outputs Integrator Transistors Q2...Q4 Connection to Oscillator How to tune? PIC SW in the frequency counter Final test RB2 Function Is this worth to build it? Pictures are better readable locally with appropriate viewer,..... Listed under: [Home Automation Projects](#)

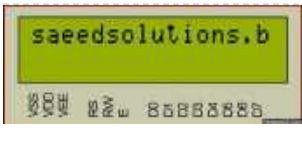
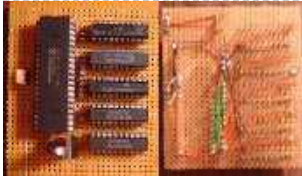

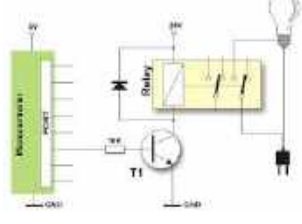
2070. [How to use PIC16F84A pin as input \(Code+Proteus simulation\)](#) This post provides an example code to use PIC16F84A pins as inputs. After going through this example, you will understand how to make PIC16F84A pins as inputs and how to read their value in the code. This code is written in C language using MPLAB with..... Listed under: [Other Projects](#), [Projects](#)

2071.  [A Cheap Ultrasonic Range Finder](#) HOW DOES IT WORK & CIRCUIT SCHEMATIC Everybody knows the speed of the sound in the dry air is around 340 m/s. Send a short ultrasonic pulse at 40 KHz in the air, and try to listen to the echo. Of course you won't hear anything,..... Listed under: [LCD Projects](#)
2072.  [A Programmable Optical Slave Flash Trigger for Digital Cameras with Processor PIC 12F675](#) The synchronizer ensures a contact-free, optical synchronization of external photographic flashguns. The triggering of the external flash is derived from embedded flashes of a camera. It can be used for both digital and "analogous" cameras or for a remote synchronization of the actual flash units..... Listed under: [Interfacing\(USB - RS232 - I2c -ISP\) Projects](#), [Video - Camera - Imaging Projects](#)
2073.  [Car Anti theft System Project using Microcontroller PIC16f73](#) For a while we have been sharing many electronic projects for engineering students and then we found out there was a huge demand for embedded projects, especially PIC microcontroller based projects. After a short break, here is another outstanding one that is not only suitable..... Listed under: [Car Projects](#)
2074.  [1-Chip 4-Channel PIC16F886 Data Logger](#) This project has only a few modifications from the "Single Chip, Four Channel Datalogger" article by Dan Gravatt in the 2008 January Issue of Nuts&Volts (page 42), so I won't go into much detail. Below is the schematic. The changes from Dan's datalogger are that..... Listed under: [Interfacing\(USB - RS232 - I2c -ISP\) Projects](#)
2075.  [Converting a Proxon MF70 Milling Machine To CNC – 4 using PIC24FJ64GB002](#) At the start of this series of posts, I said I did not want a PC to control my Milling Operations, so some local delivery method of supplying the gcode files is required. Having said that, the system is 'open', and a simple XON/XOFF terminal..... Listed under: [CNC Machines Projects](#), [Projects](#)
2076.  [Aurora 9 bar – The Essence of Aurora using PIC24F08KA microcontroller](#) Aurora 9 bar - The Essence of Aurora Since the introduction of Aurora 9x18, I received many requests for the kits and PCBs. I'm still quite undecided about making those available for a few reasons. However I really want other LED lovers (ok that might..... Listed under: [Game - Entertainment Projects](#), [LED Projects](#), [Projects](#)
2077.  [Connect Flash Card with PIC18F4520](#) The Compact Flash Library provides routines for accessing data on Compact Flash card (abbr. CF further in text). CF cards are widely used memory elements, commonly used with digital cameras. Great capacity and excellent access time of only a few microseconds make them very attractive..... Listed under: [Interfacing\(USB - RS232 - I2c -ISP\) Projects](#)
2078.  [PIC16F877 LCD code and Proteus simulation](#) This PIC16F877 microcontroller tutorial provides very detailed and comprehensive LCD[1] code. Using PIC16 simulator (Proteus) you can verify this LCD code and change it according to your needs. This code is written in C language using MPLAB with HI-TECH C compiler. You can download this code from..... Listed under: [LCD Projects](#), [Projects](#)
2079.  [contruction of personal Radar System using PIC Microcontroller PIC18f452](#) Personal Radar System using PIC Microcontroller PIC18f452 is a microcontroller hobby project. The circuit diagram of radar is attached here below seemed a little bit simple schematic but you need careful reading of PIC18f452 radar circuit to avoid any damage. The project of personal Radar..... Listed under: [Sensor - Transducer - Detector Projects](#)
2080.  [01/\atch using PIC16F913 microcontroller](#) Intro: 01/\atch The 01/\atch, because... "there are 10 types of people in the world, those who read binary, and those who don't" - a slashdot tag line. The 01/\atch is a binary wrist watch with an LED display. Additional features are accessible through a scrolling..... Listed under: [Projects](#)
2081.  [Aurora mini 18 using PIC24FV16KA302 microcontroller](#) Aurora mini 18 My obsession of this year is full-color LED. I have made Aurora 9x18 as a result. As much as I love the scale of Aurora 9x18, I also wanted to have something smaller, perhaps something that can go on a costume? Here's..... Listed under: [Other Projects](#), [Projects](#)
2082.  [Connect to the PIC Microcontroller](#) A Simple Development Board Ok, so you have now got your programmer, and you have a PIC or two. It is all very well knowing how to program the PIC in theory, but the real learning comes when you try your code on a PIC..... Listed under: [Development Board - Kits Projects](#)
2083.  [SD Memory Card Interface using pic microcontroller](#) SD memory cards, especially the ones under 1GB are cheap, relatively easy to interface and provide vast amounts of memory for imbedded control. This device lets you 'talk' to sd cards through your serial port. Communication is in ASCII so you just need a terminal..... Listed under: [Interfacing\(USB - RS232 - I2c -ISP\) Projects](#), [Memory - Storage Projects](#)
2084. [PIC12F675 Microcontroller Based Security Alarm Circuit](#) Crime in general is still on the rise, and having a security alarm installed is no longer a perquisite of the wealthy! Here is a simple and compact security alarm system to protect your home/shop and valuables. The circuit is built





around a tiny microcontroller..... Listed under: [Security - Safety Projects](#)

2085.



[Tejas Kulkarni's Lab Notebook using pic microcontoller](#) Week 01 August 15, 2010 (2 hours): Met as a team after class to finish writing preliminary project proposal. January 17, 2010 (2 hour): Brained stormed the possibilities of developing a multi-touch table. The Multi-touch table would require an external camera as an interface for..... Listed under: [Video - Camera - Imaging Projects](#)

2086.



[DMM Piggyback \(add RS-232\) using PIC16F688 microcontroller](#) DMM Piggyback (add RS-232) There are mods that give a multimeter serial connectivity by soldering some pins but, it only works if it already has RS-232 ability. So I decided rather than building a PIC multimeter from scratch, I would Piggyback off a \$4 DMM..... Listed under: [Other Projects, Projects](#)

2087.



[PICMicro Programmer with the "EiCheapo" using PIC16F84](#) Since I first released this circuit for a serial PICMicro programmer, I have been getting lots of feedback from people that have been building it as their first PICMicro programmer. It has been really nice to hear comments from people about their experiences building the..... Listed under: [Microcontroller Programmer Projects, Projects](#)

2088.



[Right-left scrolling LEDs](#) Project description: In this project, 8 LEDs are connected to PORT B of a PIC microcontroller. Also a push-button switch is connected to bit 0 of PORT A using a pull-up resistor.. When the switch is pressed the LEDs scroll to the right. Hardware: The..... Listed under: [LED Projects](#)

2089.



[PC Interfacing a GameBoy Camera using PIC18F4620 microcontroller](#) PC Interfacing a GameBoy Camera Here's another past project of mine from a couple of years ago. At that time I was looking for a low-res camera for simple robotics image processing, and all I had experience with was PIC (12, 16, and 18) microcontrollers. So I didn't really..... Listed under: [Game - Entertainment Projects, Interfacing\(USB - RS232 - I2c -ISP\) Projects, Projects, Video - Camera - Imaging Projects](#)

2090.



[Servomotor-based mobile robot control](#) Project description: Mobile robots are used in many industrial, commercial, research, and hobby applications. This project is about the control of a mobile robot using servomotors. The robot used in this project is the base of a popular mobile robot known as Boe Bot, developed..... Listed under: [Motor Projects, Robotics - Automation Projects](#)

2091.



[How-to: USB remote control receiver using pic microcontoller](#) ow that we listen to MP3s, and watch XVIDs or x264s, a computer is the entertainment center in at least one room of most homes. Unless you have a special HTPC, though, you're probably stuck using the keyboard to pause, change the volume, and fast-forward..... Listed under: [How To - DIY - Projects, Interfacing\(USB - RS232 - I2c -ISP\) Projects](#)

2092.

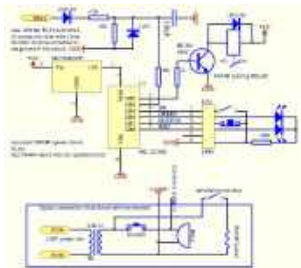

[Door lock opener](#) description This circuit can be used to operate an electric strike or an electromagnetic lock on a door. It is not the door being opened/closed, but a small electromagnetic strike which unlocks the door. The opener has the following features currently programmed in software: automatic..... Listed under: [Home Automation Projects, LED Projects](#)

2093.



[PIC microcontroller development board using pic microcontoller](#) Development board backplane Plug-in part by wave soldering process , the board also neat reverse . The curved surface of the pad foot , guaranteed not to scratch your desktop. The system uses a fully independent module design , DIY leave enough space to the..... Listed under: [Development Board - Kits Projects](#)

2094.



[Connect ADC with PIC16F877](#) ADC (Analog to Digital Converter) module is available with a number of PIC MCU modules. ADC is an electronic circuit that converts continuous signals to discrete digital numbers. ADC Library provides you a comfortable work with the module. Library Routines ADC\_Init ADC\_Get\_Sample ADC\_Read ADC\_Init Prototype..... Listed under: [Metering - Instrument Projects](#)

2095.

[Connect ADC with PIC16F877](#) ADC (Analog to Digital Converter) module is available with a number of PIC MCU modules. ADC is an electronic circuit that converts continuous signals to discrete digital numbers. ADC Library provides you a comfortable work with the module. Library Routines ADC\_Init ADC\_Get\_Sample ADC\_Read ADC\_Init Prototype..... Listed under: [Metering - Instrument Projects](#)



2096.



[Connect CAN Protocol with PIC](#) The mikroC PRO for PIC provides a library (driver) for working with the CAN module. The CAN is a very robust protocol that has error detection and signalization, self-checking and fault confinement. Faulty CAN data and remote frames are re-transmitted automatically, similar to the Ethernet..... Listed under: [Internet - Ethernet - LAN Projects](#)

2097.



[Connect CAN-SPI with PIC Controller](#) The SPI module is available with a number of the PIC compliant MCUs. The mikroC PRO for PIC provides a library (driver) for working with mikroElektronika's CANSPI Add-on boards (with MCP2515 or MCP2510) via SPI interface. The CAN is a very robust protocol that has..... Listed under: [Interfacing\(USB - RS232 - I2c -ISP\) Projects](#)

2098.



[Real Time Clock Circuit using Mircocontroller](#) Here I am going to teach you a simple circuit of 24 hour digital clock display that can also be used in 12 hour format by simply loading the corresponding clock program. You can download the hex files for both 12 hour format and 24..... Listed under: [Clock and Timer Projects](#)

2099.

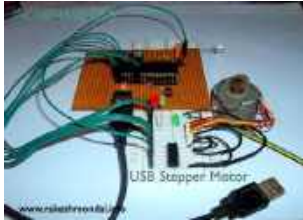

[USB Stepper Motor Driver using pic microcontoller](#) USB Stepper Motor Driver In this project we are going to drive a unipolar Stepper motor (5 wire) using USB interface from a PC Computer. This project is an application of the USB Interface Board PIC18F4550 which was published here in the past. You can..... Listed under: [Interfacing\(USB - RS232 - I2c -ISP\) Projects](#), [Motor Projects](#)

2100.

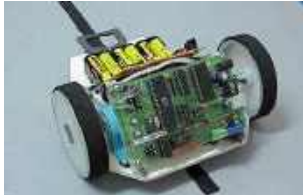

[C-52EVB Robot Controller](#) Use a C-52 EVB for simple robot experiments. Build a simple two wheels robot with L293D H-Bridge driver and IR sensors. Write a C program controls robot tracked with black tape. Fun with Ving-Peaw Competition 2543, course layout, day-by-day changed rule and scoring also included!..... Listed under: [Robotics - Automation Projects](#)

2101.



[Rainbow LED Chaser](#) I was bored this past sunday, and needed something to ease my racing brain ... so I picked an easy project with lots of flash. The parts list: Eight Tri-Color or RGB leds ... each led package contains three LEDs Three 74HC595 Shift Registers ..... Listed under: [LED Projects](#)

2102.



[NJM2035 – HI-FI Stereo Encoder / Multiplexer using pic microcontoller](#) Part's List: 2x 47K 1x 10K 1x 82K 1x 50K POT 1x 33uF 1x 10uF 3x 100nF (104) 1x 100pF (101) 1x 10pF (10) 1x NJM2035 IC 1x 38 KHz Crystal Technical Specifications: Voltage Supply: 1.2V - 3.6V MAX Current Draw: >3mA Channel Separation: <..... Listed under: [Sound - Audio Projects](#)

2103.

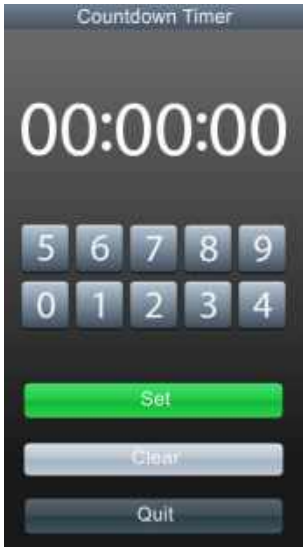

[Countdown Timer using PIC16F690 microcontroller](#) This is a simple countdown-timer-on-a-chip project - you program the PIC, attach some buttons and a pair of 2-segment LEDs, and you are done. I used this timer for one of my projects, but I tried to make that timer as generic as possible, so..... Listed under: [Clock and Timer Projects](#)

2104.







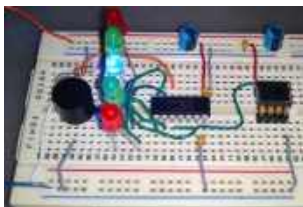







[Introducing PIC Microcontroller projects](#) PIC Microcontroller Development Tools History PIC microcontroller Development Board (Completed on 2006-10-28) The ultimate PIC Microcontroller development board. After years of programming PIC microcontroller, I have finally design my super development board to program PIC microcontroller firmware. The automatic programming mode select and the 40..... Listed under: [Microcontroller Programmer Projects](#)

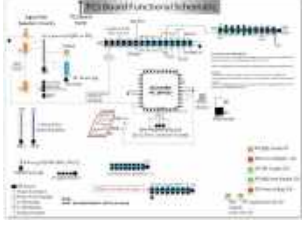



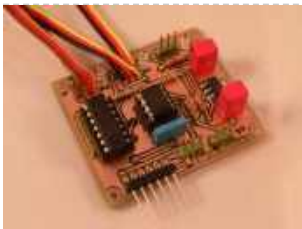





2105.



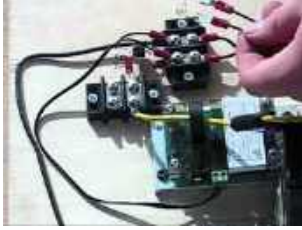
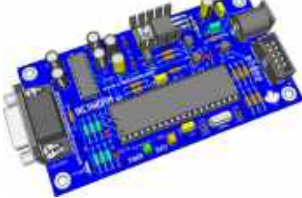

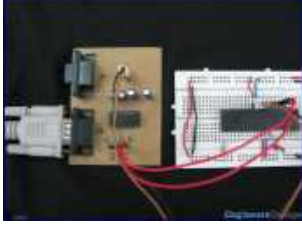

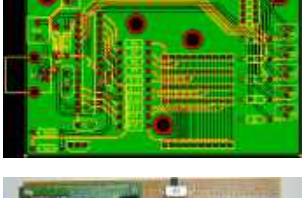



[Build a digital spirit level using a SCA610 accelerometer using PIC16F684](#) A bubble or spirit level meter, like the DIY Digital Spirit, is a handy tool to find whether a surface is horizontal or vertical. It is often carried by civil engineers, mechanical engineers, surveyors, carpenters, and many other professionals whose work involves precise alignments of..... Listed under: [Metering - Instrument Projects](#), [Projects](#)

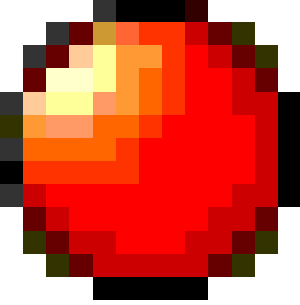

2106.  [Music player built on microcontroller AT91SAM7S256 with ARM core](#) 1. The player allows: playback wav files in stereo format, 22,500Hz frequency, and 8 bits of resolution, display the song titles, display time of songs, the possibility of stopping (pause) and switch songs, the possibility of change volume (+, -), read data from the MMC..... Listed under: [Sound - Audio Projects](#)
2107.  [Seven Segment Display Thermometer with PIC Microcontroller](#) The seven segment display is one of the most popular numeric displays used in many microcontroller applications because it's cheap, robust and reliable. The seven segments actually consists of 8 LED (Light Emitting Diode) and it's come with various sizes suitable for various numeric display..... Listed under: [Metering - Instrument Projects](#)
2108.  [PIC16F84 Evaluation Board](#) Introduction When I set, some time ago, about working with a PIC 16x84, I had immediately to face the problem to have a permanently and stably working circuit, without mounting the PIC on a prototype board every time. Searching on the net, I didn't find..... Listed under: [Development Board - Kits Projects, Projects](#)
2109.  [Microcontroller Controlled Metal Detector Projects](#) Result of displays in the form of two scales, which are estimated to judge the material goal. In addition, the screen is small scale level of response and the current supply voltage. PIC18F252 The program is intended for controller PIC18F252. The controller PIC16F873 (A) to this version..... Listed under: [LCD Projects](#)
2110.  [Gen 3.2 PCS Board Design](#) Gen 3.2 General Microservers, Vexcel Microservers, Quick Reference, Data Acquisition, Middleware Components GPS, SBC Configuration ..... Listed under: [Development Board - Kits Projects](#)
2111.  [Q-matic Circuit Application of PIC16F877 Microcontroller](#) In this article I used in banks and hospitals will give information about the Q-matic s. I've done a routing circuit board (main board) and consists of three separate teller. Routing PIC16F877 on board, if the teller did not use pic16f876 in each. Teller as..... Listed under: [LED Projects](#)
2112.  [The Ultra-QP An Ultrasound QSO Party Rig Fun & Educational!](#) Imagine veterans and potential radio licensees gathered in a classroom, seated side-by-side facing the front, headphones on and a key at hand – both plugged into their QSO Party Rigs they each built the previous week - exchanging code as directed by designated net control!..... Listed under: [Game - Entertainment Projects](#)
2113.  [PIC16F628 4 RGB LED PWM Controller using pic microcontroller](#) I am a big fan of LEDs. Bright, colorful, flashing LEDs. So, given my affinity for LEDs, I decided to work on a controller that me and a few of my friends could use as an art project/passive information display. I have posted videos from..... Listed under: [LED Projects](#)
2114.  [PIC18F2550 : Blink LED using XC8 Compiler](#) Welcome to another chapter of PIC18F programming Tutorial. In this chapter we are going to program a simple 28 pin PIC18F2550 microcontroller using mplabx IDE and XC8 Compiler. The concepts for programming a pic18f2550 microcontroller is still going to be almost same as previous tutorials..... Listed under: [LED Projects](#)
2115.  [RC Servo Switcher using pic microcontoller](#) Introduction Some fellow members of The Abbenay Hackspace (an open hacker space based in Stockholm, Sweden) are embarked on an ambitious project with the aim of being the first to build an autonomous sailing robot which is capable of circumnavigating the Earth. The project is..... Listed under: [Robotics - Automation Projects](#)
2116.  [USB Interface Board Tutorial Using PIC18F4550](#) USB Interface Development Board Tutorial -1 STAGE/PART-1 MAKING OF THE MAIN CIRCUIT BOARD CONTROL YOUR DEVICES FROM COMPUTER USING USB PORT – pic18f4550 + MPLAB IDE INTRODUCTION ( USB PROJECT) : STEP 1 This project demonstrates a computer control interface using a USB Board. (USB..... Listed under: [Interfacing\(USB - RS232 - I2c -ISP\) Projects](#)
2117.  [Infrared IR Sensor Interface with PIC18F4550 Microcontroller](#) IR Sensor Interface with PIC18F4550 In my previous project we have made a simple IR sensor Circuit. In this project, as promised before – we are going to demonstrate a PIC18F4550 microcontroller interface to IR sensor circuit. We are just going to glow few on..... Listed under: [Sensor - Transducer - Detector Projects](#)
2118.  [Stepper Motor Speed Control with PIC18F4550](#) Stepper Motor Drivers USB Stepper Motor Driver Stepper Motor Driver PIC18F4550 --Stepper Motor schematics Stepper Motor Speed Controller Stepper Motor driver PIC18F2550 IR Interinterface to Stepper Motor Stepper Motor Speed controller using PIC18F4550 This tutorial is all about tuning the speed of a stepper motor..... Listed under: [Motor Projects](#)

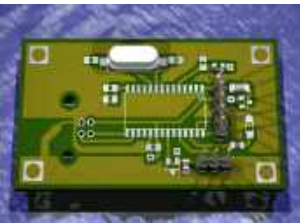
2119.  [A DDS Module based on the AD9835 using PIC16F84](#) Table of contents Purpose Disclaimer Schematics PCB Pictures of the finished module Notes & comments SSTV Testgenerator Credits Purpose While working on a project I came across the DDS chips from Analog Devices. Especially the AD9835 was very attractive to me because of its super simple..... Listed under: [Other Projects](#), [Projects](#)
- 
2120.  [How to interface MAXIM's DS1868 digital potentiometer with a PIC microcontroller](#) Potentiometers find applications in many electrical devices. For example, a light dimmer uses a potentiometer to control the brightness of lamps. In amplifiers, they are used to control the output volume of the music, or change the bass level. In an adjustable power supply we..... Listed under: [How To - DIY - Projects](#), [Interfacing\(USB - RS232 - I2c -ISP\) Projects](#)
- 
2121.  [PIC16F84A Gas Detector using GH-312 sensor](#) Introduction This is a gas detecting circuit capable of sensing many different types of gases. The sensor used is the GH-312 and from the datasheet it is capable of sensing gases like smoke, liquefied gas, butane and propane, Methane, alcohol, hydrogen, etc. Schematic Parts List R1 ..... Listed under: [Sensor - Transducer - Detector Projects](#)
- 
2122.  [Stepper Motor Driver using PIC18F4550 Microcontroller](#) Stepper Motor Tutorial In this tutorial we are going to drive a Single unipolar stepper motor using PIC18F4550 Microcontroller in various different stepping modes. The source code and Project files are free to download at the end of this page. - Stepper motor due its..... Listed under: [Motor Projects](#)
- 
2123.  [Serial Data Logger with PIC microcontroller](#) The data logger consists of a simple op-amp amplifier circuit that amplifies the signal and sends it to be digitized by a PIC16F688 microcontroller, serialized, and sent to the computer's serial port via a MAX232 serial driver: I guess you are already wondering about some..... Listed under: [Interfacing\(USB - RS232 - I2c -ISP\) Projects](#)
- 
2124.  [Building the Inchworm ICD2 PIC Programmer / Debugger using PIC16F877](#) Building the Inchworm ICD2 PIC Programmer / Debugger This instructable is an illustrated walk through building an ICD2 clone called the Inchworm. It's a straight forward kit that lets you build an MPLAB ICD2 compatible Programmer and Debugger. There are lots of Programmers out there..... Listed under: [Microcontroller Programmer Projects](#), [Projects](#)
- 
2125.  [8 Channel IR Remote Control](#) This IR remote control that you can use to control other devices or circuits up to 8 devices. The control codes are sent in RC5 format modulated to about 38 kHz carrier frequency. The IR transmitter powered by the CR2016 which is a 3V button Cells..... Listed under: [Home Automation Projects](#)
- 
2126.  [How to configure EUSART in PIC18F4550](#) Both, Parallel and Serial modes of communication have certain advantages and disadvantages over one another. The serial communication is a preferred option due to its ability of long distance communication with error detection capability. The microcontrollers consist of an inbuilt hardware unit known as USART..... Listed under: [How To - DIY - Projects](#), [Projects](#), [Tutorials](#)
- 
2127.  [Discolight effect with bass beat control using PIC16F84A](#) Short description of the operation: External circuit converts bass beat of music into pulses. The motor is controlled by them. If theres bass beat recognised then the motor rotates one direction (in full stepping) for a predefined time then stops. If the second beat comes..... Listed under: [LED Projects](#)
- 
2128.  [PIC18F2550 Project Board using pic microcontroller](#) The new PIC18F2550 Project Board was designed as the development platform for student projects. The board features MCU: PIC18F2550 with external xtal, ADC: one channel 0-2.5V sigma-delta converter, Linear Technology LTC2400/LTC2420, 6-channel 10-bit ADC 0-5V, Display: Two connectors for text LCD or GLCD, USB: onchip..... Listed under: [Development Board - Kits Projects](#)
- 
2129.  [LED Persistence of Vision Display](#) Electrical The main components of the electrical system were the timing system and the LED control system for 40 LEDs using a single PIC. A schematic of the system is shown below (click for larger view): timing In order to time the display properly to..... Listed under: [LED Projects](#)
- 
2130.  [USB & GLCD expansion board for 8051SBC using pic microcontroller](#) Simple expansion board for 8051SBC provides easy USB port and graphic LCD interface. I am planning to design the x86 board for some of my application that needs more computing capability. One of the features that I need to add to the x86 board is..... Listed under: [Interfacing\(USB - RS232 - I2c -ISP\) Projects](#)

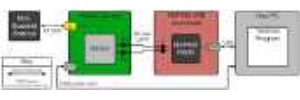

2131.  [Connect I<sup>2</sup>C with PIC](#) The I<sup>2</sup>C full master MSSP module is available with a number of PIC MCU models. mikroC PRO for PIC provides library which supports the master I<sup>2</sup>C mode. Important : Some MCUs have multiple I<sup>2</sup>C modules. In order to use the desired I<sup>2</sup>C library routine,..... Listed under: [Interfacing\(USB - RS232 - I2c -ISP\) Projects](#)
- 
2132.  [Digital DCF77 clock with LCD and gong using PIC16F628A](#) Always the right time and date with DCF77 This project make use of a PIC16F628(A) and a DCF77 receiver from Conrad (Orderno. 64 11 38) Optional there is a possibility to connect an electronic gong on it. Click for information about DCF77 on the link underneath: The working..... Listed under: [Clock and Timer Projects](#), [Home Automation Projects](#), [LCD Projects](#)
- 
2133.  [The One Chip Spinning RGB POV Display with conversion software using PIC18f4680 microcontroller](#) The 'One Chip Spinning RGB POV Display' with conversion software. If you have been on the look out for a project that combines, RGB LED's, a motor, a microcontroller and a ridiculous amount of hot melt glue, then you have certainly come to the right..... Listed under: [Other Projects](#), [Projects](#)
- 
2134.  [Connect Matrix Keypad with PIC Controller Code](#) The mikroC PRO for PIC provides a library for working with 4x4 keypad. The library routines can also be used with 4x1, 4x2, or 4x3 keypad. For connections explanation see schematic at the bottom of this page. External dependencies of Keypad Library The following variable..... Listed under: [Interfacing\(USB - RS232 - I2c -ISP\) Projects](#)
- 
2135.  [PIC Evaluation/Development Board Implementation using pic-microcontroller](#) Abstract The objective of this project is to produce a PIC evaluation/development board to be used by future ECPE senior design project teams. Many project implementations call for some sort of microcontroller unit in the final product, and this need can often be met by..... Listed under: [Development Board - Kits Projects](#)
- 
2136.  [USB Indoor/Outdoor Thermometer using PIC18F2550 microcontroller](#) USB Indoor/Outdoor Thermometer (or, 'My first USB device') This is a simple design that demonstrates the USB peripheral on the PIC 18Fs. There are a bunch of examples for the 18F4550 40 pin chips online, this design demonstrates the smaller 18F2550 28 pin version. The..... Listed under: [Interfacing\(USB - RS232 - I2c -ISP\) Projects](#), [Temperature Measurement Projects](#)
- 
2137.  [Connect Memory Card using PIC18F4520 Code](#) The Multi Media Card (MMC) is a Flash memory card standard. MMC cards are currently available in sizes up to and including 32 GB and are used in cellular phones, digital audio players, digital cameras and PDA's. mikroC PRO for PIC provides a library for..... Listed under: [Memory - Storage Projects](#)
- 
2138.  [Connect USB HID with PIC18F4450 Code](#) Universal Serial Bus (USB) provides a serial bus standard for connecting a wide variety of devices, including computers, cell phones, game consoles, PDA's, etc. USB Library contains HID routines that support HID class devices, and also the generic routines that can be used with vendor..... Listed under: [Interfacing\(USB - RS232 - I2c -ISP\) Projects](#)
- 
2139.  [GSM Based Versatile Robotic Vehicle Using PIC Microcontroller](#) This project is designed to develop as a robotic vehicle that can be controlled by a cell phones. DTMF commands from a phone send to another cell phone which is mounted on the robotic vehicle. These commands are fed to a PIC microcontroller of 8-bit..... Listed under: [Robotics - Automation Projects](#)
- 
2140.  [TechBot line following robot using PIC16F84](#) Design Goal: The TechBot1 is a small line following robot designed for for the 1998 Embedded Systems conference in San Jose California. It was built by Jerry Merrill and myself and was designed as a promotional robot that would follow a black line drawn on..... Listed under: [Projects](#), [Robotics - Automation Projects](#)
- 
2141.  [UART Communication using PIC Code](#) The UART hardware module is available with a number of PIC compliant MCUs. The mikroC PRO for PIC UART Library provides comfortable work with the Asynchronous (full duplex) mode. You can easily communicate with other devices via RS-232 protocol (for example with PC, see the..... Listed under: [Interfacing\(USB - RS232 - I2c -ISP\) Projects](#)
- 
2142. [Connect Ethernet controller with PIC Code](#) The ENC28J60 is a stand-alone Ethernet controller with an industry standard Serial Peripheral Interface (SPI). It is designed to serve as an Ethernet network interface for any controller equipped with SPI. The ENC28J60 meets all of the IEEE 802.3 specifications. It incorporates a number of..... Listed under: [Internet - Ethernet - LAN Projects](#)



2143. [Create Musical Tone using PIC Code](#) The mikroC PRO for PIC provides a Sound Library to supply users with routines necessary for sound signalization in their applications. Sound generation needs additional hardware, such as piezo-speaker (example of piezo-speaker interface is given on the schematic at the bottom of this page). Library..... Listed under: [Sound - Audio Projects](#)



2144. [Project Ryu Lager Guitar Pedal Take 3 using pic microcontoller](#) It has been a quiet period but a very busy period, very active and very fruitful. I will be launching the projectryu.com site soon with tons of free resources for the audio hobbyist. Getting back to the title of this post, i would like to..... Listed under: [Sound - Audio Projects](#)



2145. [Extend I/O Ports using PIC Microcontroller](#) The mikroC PRO for PIC provides a library for communication with the Microchip's Port Expander MCP23S17 via SPI interface. Connections of the PIC compliant MCU and MCP23S17 is given on the schematic at the bottom of this page. Important : The library uses the..... Listed under: [Interfacing\(USB - RS232 - I2c -ISP\) Projects](#)



2146. [Thermometer with PIC Microcontroller](#) In the last tutorial we learn about the multiplexing technique used with seven segment displays. We learnt how it saves i/o line by using persistence of vision. Only one digit is lit at a time, but to a human eye it is too fast to..... Listed under: [Metering - Instrument Projects](#)



2147. [Multiple Servomotors](#) Using a modified version of the last program, we can control as many servomotors as we have I/O lines on port B. In the next listing, we will control two servos in the same manner as we controlled a single servo in the previous program..... Listed under: [Motor Projects](#)

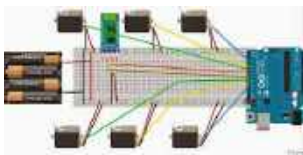

2148. [Intelligent Fan Controller. Part 1 – Schematic using pic microcontoller](#) he Intelligent Fan Controller is designed to control the noise generated by the fans inside your computer. It does this by varying their speed based on temperatures measured inside the case. When it is cool the fans will run slowly and they will only speed..... Listed under: [Temperature Measurement Projects](#)



2149. [12F675 Tutorial 5 : A Temperature data logger using PIC EEPROM. using pic microcontoller](#) EEPROM is useful for storing long term data such as data logger information and this PIC microcontroller EEPROM project saves the temperature from an LM35DZ IC to the PIC's internal long term data storage area. The project follows on from the last project using the..... Listed under: [Temperature Measurement Projects](#)

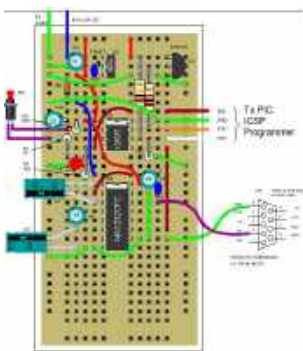

2150. [Rotary Encoders](#) Rotary encoders are very versatile input devices for microcontroller projects. They are like potentiometers expect of digital nature and unlike analogue potentiometers they never wear down. Rotary encoders not only provide 360 degrees of rotational freedom they also allow digital positioning information to be gained..... Listed under: [LED Projects](#), [Motor Projects](#)

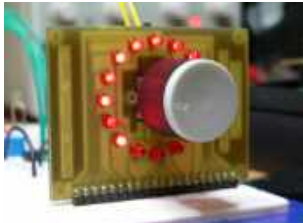

2151. [Universal Serial Infrared Receiver. using pic microcontoller](#) You can use this Universal Infrared Receiver (UIR) project to control your PC: Starting Windows programs, setting the Windows volume control, even moving the mouse around the screen! All at the touch of a button - with your TV remote control in fact! It uses a..... Listed under: [Wireless Projects](#)

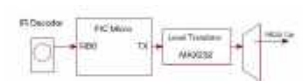

2152. [Relay Timer with PIC16F628](#) Here is 0 to 99 minutes relay timer using PIC16F628 microcontroller and 16 character LCD display. The microcontroller is PIC16F628A running at 4.0 MHz clock using an external crystal. An HD44780 based 16x2 character LCD is the main display unit of the project where you..... Listed under: [Clock and Timer Projects](#), [LCD Projects](#)



2153. [Making a binary clock using a PIC Microcontroller](#) You can use a PIC microcontroller and an LED matrix to create a binary clock (or if you prefer you can wire up individual LEDs). This project uses an LED matrix block as it saves lots of wiring. So what is it ? Its an..... Listed under: [Blog](#), [Clock and Timer Projects](#)



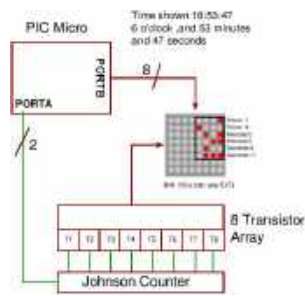

2154. [Schematics and C code for a 0-5V PIC LCD Volt Meter. using pic microcontoller](#) This PIC LCD volt meter project uses a PIC micro and an HD44870 LCD display. The analogue input is taken directly to the analogue input pin of the microcontroller without any other processing. Specification Voltage range 0V - 5V Input signal level TTL Maximum input..... Listed under: [LCD Projects](#), [Metering - Instrument Projects](#)



2155. [Night Light Saver V3.2 \(PIC12C508\)](#) Introduction It's time for 8-pin microcontroller Microchip PIC12C508, the SAVER V3.2, my latest design of a device that turns a night light on and off everyday. The circuit uses only a PIC12C508 8-pin CMOS micontroller and a small triac, MAC97A6. The Saver V3.2 also demonstrates..... Listed under: [LED Projects](#)

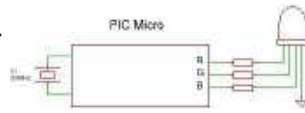

2156. [How to drive an rgb led using three microcontroller pins. using pic microcontoller](#) The RGB LED contains three LEDs encased in one shell: Red, Green and Blue (some contain an extra blue led - as blue LEDs generate less output intensity (candela) per mA). It looks like a single white led except that it has four leads -..... Listed under: [LED Projects](#)

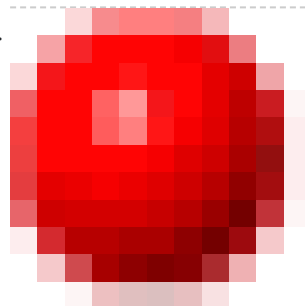

2157. [Wisp628 an in-circuit flash PICmicro Programmer](#) Features in-circuit programmer programs flash PICmicro's supports a rapid cycle of code/program/test prototype programmer takes power from the target circuit serial interface serial passthrough to the target Foremost Wisp628 is an in-circuit programmer. The programmer is connected to a few pins of the target..... Listed under: [Interfacing\(USB - RS232 - I2c -ISP\) Projects](#)

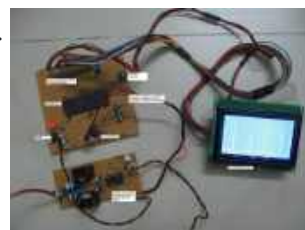

2158. [A simple spectrum analyzer using dsPIC30F4011](#) This is a project for viewing the frequency spectrum of input signal using dsPIC. The hardware uses the following: - 1. dsPIC30F4011. 2. Opamp (any one, like LM358, TL084). 3. Power supply. Software includes the following: - 1. FFT library code from Microchip 2. Graphic..... Listed under: [Projects](#), [Sound - Audio Projects](#)



2159. [Hidden Radio Transmitter Controller](#) PicCon is a PIC microcontroller based radio controller designed for hidden transmitter hunting. When combined with a radio transmitter, it will produce tone sequences and Morse code messages at user-programmed times. It is completely field programmable via DTMF tones, utilizes EEPROM for all programmed options..... Listed under: [Radio Projects](#)

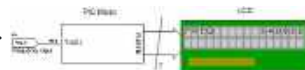

2160. [A PIC frequency counter operating up to about 50 MHz. usnig pic microcontoller](#) This PIC frequency counter project uses an LCD to display the frequency and PIC timer 1 to measure the input signal and Timer0 to measure the timing period. It uses Timer 1 in 16 bit counter mode to count the input signal edges and overflows..... Listed under: [Calculator Projects](#)

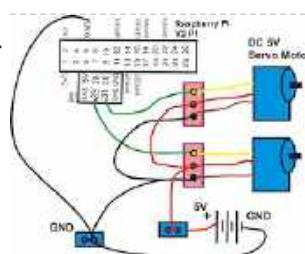

2161. [First Servomotor Control Program](#) In our first program , we will simply sweep the servomotor from CCW to CW and then sweep back. The program will be kept simple as to demonstrate the principles of controlling a servo with a the PIC Basic language. The schematic can be seen..... Listed under: [Motor Projects](#)



2162. [Localizer with SIM908 module using PIC18LF6722](#) The device is based on a GSM/GPRS module with included GPS. Its main function is to detect and communicate its own geographical position using, on the choice, the cellular phone reference system or the GPS. Its small dimensions are due to the use, for the..... Listed under: [GPS Based Projects](#), [Phone Projects](#), [Projects](#)

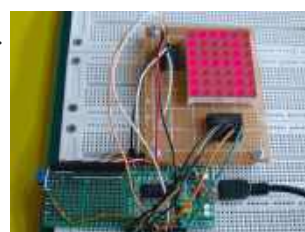

2163. [Led Display Boards InBulk using pic microcontoller](#) We covered how to interface seven segment LED displays to a PIC microcontroller in two sections: Lab 6 and Lab 11. Today, we will move on to interfacing an LED dot matrix display. LED dot matrices are very popular means of displaying information as it..... Listed under: [LED Projects](#)

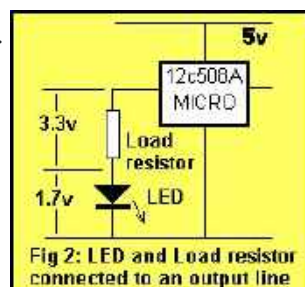

2164. [A discussion on the drive-current for the outputs of a PIC12C508A microcontroller](#) Each of the output lines of a '508A microcontroller can deliver a maximum of 25mA. What does this mean? It means any device connected to the line must take 25mA or less. If it takes more than 25mA a buffer transistor (also called an amplifying transistor)..... Listed under: [Battery Projects](#), [Interfacing\(USB - RS232 - I2c -ISP\) Projects](#)

2165. [The Saltwater etch process using PIC16F54 microcontroller](#) The Saltwater etch process This is a one-off process to produce one printed circuit board by removing unwanted copper by electrolysis in a saltwater solution. I shall illustrate the process by etching and building a board for 18-

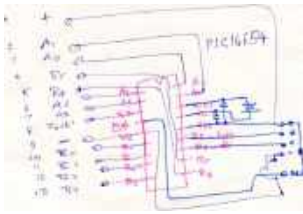

pin PIC (for the PC16F54, but any 18..... Listed under: [Other Projects](#), [Projects](#)

2166.



[DS18S20 Dual Temperature Meter using pic microcontroller](#) DS18S20 Dual Temperature Meter Component List: 1x 2x16 LCD with Backlight 1x 16x1 LCD Female Header Connector 1x 16x1 LCD Male Header Connector 1x Programmed PIC16F628 2x DS18S20 1-Wire Digital Temperature Sensor 1x 100nF Capacitor 1x 10K Pot (LCD Contrast) 1x 10K Resistor 2x 1K..... Listed under: [Metering - Instrument Projects](#), [Temperature Measurement Projects](#)

2167.



[Automatic door opener with PIC12C508 Circuit](#) Description This circuit can be used to operate an electric strike or an electromagnetic lock on a door. It is not the door being opened/closed, but a small electromagnetic strike which unlocks the door. The opener has the following features currently programmed in software: automatic..... Listed under: [Home Automation Projects](#)

2168.

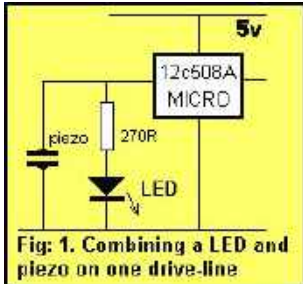

[10 tricks for interfacing to the PIC16C508](#) Most of the ideas in this chapter can be found on the pages of this website, but just in case you want to go over the capabilities of the '508A, we have brought them together. Quite often when you are programming, the first thing you..... Listed under: [Interfacing\(USB - RS232 - I2c -ISP\) Projects](#), [LED Projects](#)

2169.

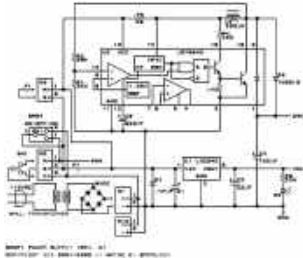

[EMDP1 — Extensible Multiple Device Programmer 1 \(Rev. C\) using pic microcontroller](#) Table of Contents Table of Contents Introduction Schematics Printed Circuit Board Issues Introduction This is revision C of the EMDP1 mother board. It differs from revision B in that a 40-pin ZIF (zero insertion force) socket and an 80-pin 'universal' plug have been added. This..... Listed under: [Microcontroller Programmer Projects](#)

2170.



[Very Accurate LC Meter based on PIC16F628A](#) About Accurate LC Meter This is one of the most accurate and simplest LC inductance / capacitance Meters that one can find, yet one that you can easily build yourself. This LC Meter allows to measure incredibly small inductances starting from 10nH to 1000nH, 1uH..... Listed under: [LCD Projects](#), [Metering - Instrument Projects](#)

2171.



[DIY MIDI controllers using PIC microcontrollers and Basic Stamps using pic microcontroller](#) Introduction By combining a PIC microcontroller or Basic Stamp II with a few passive components it is not difficult to construct your own knob box, trigger box, or other MIDI input device. A knowledge of electronics may be required for interfacing to some sensors. Both..... Listed under: [How To - DIY - Projects](#)

2172.

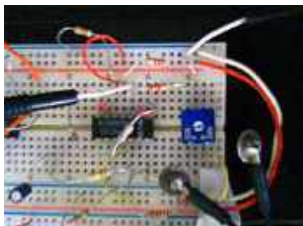

[Talk:Wireless Affective Devices using pic microcontroller](#) Contents 1 Project aims 2 Previous work 3 Project the device 3.1 Re-definition of the complete work 3.2 Sensors Design 3.3 Microcontroller 3.4 Wireless Connection 4 Prototype realization [WIP (Work in Progress)] 4.1 Main board 4.2 USB interface 4.3 BVP 4.4 GSR 4.5 Acceleration 4.6..... Listed under: [Wireless Projects](#)

2173.

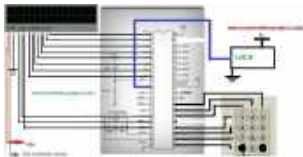

[Automatic door lock system using 8051\(89c51,89c52\) microcontroller](#) Automatic door locks are becoming popular in industry and many companies and industries are using automatic door locks systems for the safety of their rooms. They are popular in banks. Banks use automatic lock systems to keep security of their money stored in a single..... Listed under: [Home Automation Projects](#)

2174.

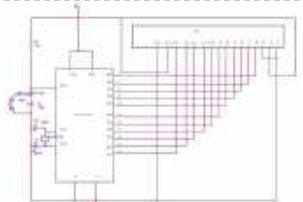

[Interfacing 16X2 LCD with PIC Microcontroller](#) In this session we will see how to interface 16x2 LCD to PIC18F4550 microcontroller which is of family PIC18F. You can get information of 16x2 LCD in the session How to Interface 16X2 LCD with 8051 Microcontroller Features of PIC18F4550: PIC18F4550 belongs to the PIC18F family;..... Listed under: [LCD Projects](#)

2175.











[Obstacle Sensing Walking Stick for Visually Impaired Persons : Block Diagram](#) From the block diagram given above you can see that this project has four major parts. The Power Bank Finding a good power source for this project was a challenge, the power supply should have to be mobile, so that we cannot use power adapters..... Listed under: [Sensor - Transducer - Detector Projects](#)





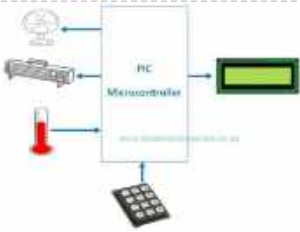
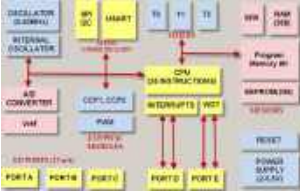

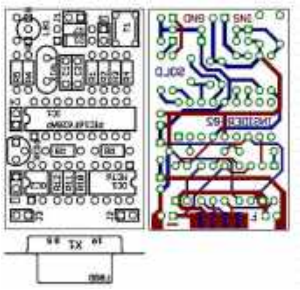

2176.

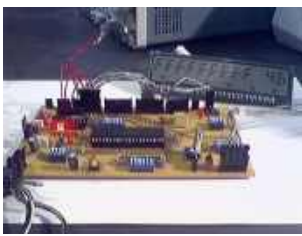

[GPS-based universal clock generator using PIC16F628](#) GPS satellites and GPS Ground Segment need extremely accurate timing to allow GPS users to know their own position on the Earth. Rubidium and Cesium clock generators are extensively used and maintained to synchronize and generate the signals that our inexpensive navigator gets from the..... Listed under: [Clock and Timer Projects](#), [GPS Based Projects](#)

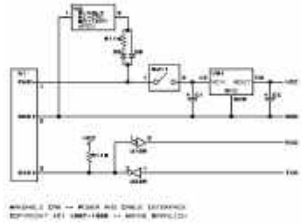
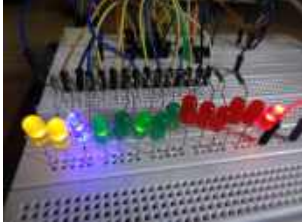
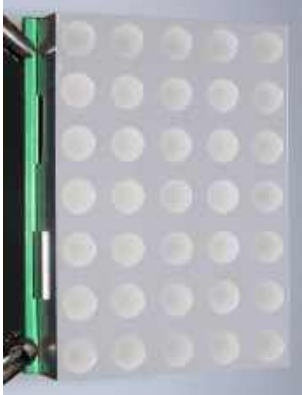

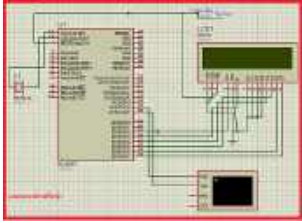
2177.  [Low cost temperature data logger using PIC and Processing](#) This project describes an easy and inexpensive way of adding a digital thermometer and data logging feature to a PC. It involves a PIC microcontroller that gets the surrounding temperature information from the Microchip MCP9701 sensor, and sends it to a PC through an USB-UART..... Listed under: [Temperature Measurement Projects](#)
2178.  [Self-made development board for the 32-bit PIC32MX220F032B Microcontroller](#) Few months ago Microchip introduced smallest, lowest-cost PIC32 microcontrollers – new PIC32“MX1” and PIC32“MX2” families. PIC32 MX1 and MX2 MCUs include up to 32 KB of Flash and 8 KB of SRAM, two I2S interfaces for audio processing, 10-bit 1 Msps ADC, an 8-bit Parallel..... Listed under: [Development Board - Kits Projects](#)
2179.  [Microchip – Let my robot see! using pic microcontoller](#) I promised to post some of my past microcontroller vision projects. This one has a Microchip PIC directly sampling a video signal. 8 pins well used. Collapsible Quadruped Robot with Computer Vision, Laser Ranging, and Servo Control on a Single-Wire Network Photos and video capture..... Listed under: [Robotics - Automation Projects](#)
2180.  [PIC – First Project](#) Programming in PIC microcontroller can be done by using assembly language or by using Embedded C because of the ease of writing code. We have used done the programming through Embedded C language. For programming any microcontroller we need a IDE or Intregrated Developement Enviroment. In case of..... Listed under: [Other Projects](#)
2181.  [A simple programmer for PIC microcontrollers](#) Perhaps this circuit is the simplest programmer for PIC microcontrollers you can build. It is connected to serial port of your PC and it has a very similar design with the SI-Prog programmer for the AVR microcontrollers. With the help of adaptors you can extend..... Listed under: [Microcontroller Programmer Projects](#)
2182.  [Automatic Temperature Control System using PIC Microcontroller – XC8](#) An automatic temperature control system has the ability to monitor and control the temperature of a specified space without human intervention. The primary purpose is to manage the temperature of a given area based on settings by a user of the system. This project uses..... Listed under: [Temperature Measurement Projects](#)
2183.  [Electronic Distance Meter using pic microcontroller](#) Measure distance while riding bicycle. Direct display in meter unit. Battery operated with Nitron 68HC908QY4, 16-pin MCU. Figure 1: Prototype of Distance Meter. This project demonstrates the use of 16x1 line LCD module to interface with Nitron 16-pin MCU, 68HC908QY4. The original idea came from..... Listed under: [LCD Projects](#), [Metering - Instrument Projects](#)
2184.  [PIC Microcontroller Architecture and Applications](#) PIC microcontroller was developed in the year 1993 by microchip technology. The term PIC stands for Peripheral Interface Controller. Initially this was developed for supporting PDP computers to control its peripheral devices, and therefore, named as a peripheral interface device. These microcontrollers are very fast..... Listed under: [Microcontroller Programmer Projects](#)
2185.  [Circuit-Zone.com – Electronic Projects](#) For a long time I needed a good programmer pussy, even if it is programming, so from time to time the application gets where it is used. So I decided to build the programmer. I chose between a couple of projects from different authors, but..... Listed under: [LED Projects](#)
2186.  [In-Circuit debugger, created by E.E. Atanasios Melimopoulos using PIC16F628 microcontroller](#) This project was sent by Electrical Engineer Atanasios Melimopoulos (Copyright (c) June 15, 2007) INTRODUCTION: In-Circuit-Debuggers, as you may already know, have become the PIC's debugging standard tool for many programmers because it's easy use and handy interface to the target picplaced- board. They come..... Listed under: [PWM Projects](#)
2187.  [Electronic Quiz Buzzer Circuit Diagram using PIC Microcontroller](#) Usually high level quiz competitions are very much time-oriented as it becomes significant to determine who has answered first. So here we'll see how to make a buzzer system that helps to decide the winners. Actually I designed this circuit of buzzer for quiz program..... Listed under: [LED Projects](#)
2188.  [How to set up your B&W Zeppelin Air](#) With the B&W Zeppelin Air being such a popular iPod docking station as well as a fantastic AirPlay compatible device we thought it would be a good idea to write a 'how to' on setting up your new Zeppelin Air. As of September 2012 newer..... Listed under: [Sound - Audio Projects](#)

2189.  [PIC16F877 Development Board v. 1.2](#) The Development Board v. 1.1 connected to an LCD display. It is well visible (read further, in the description) the row of LEDs used to check the logic state of up to 8 I/O ports or external circuits' pins. Of course, if you own an..... Listed under: [Development Board - Kits Projects, Projects](#)
2190.  [Marantz CD63SE laser transport mechanism replacement](#) An elderly, but still sought after Marantz CD63SE was bought into the shop last week, with the fault reported that CD's would no longer play. After approximately 15 years of use, this is a common situation, as the laser power will gradually reduce over time..... Listed under: [Video - Camera - Imaging Projects](#)
2191.  [eDrum - Trigger MIDI Converter using PIC16F877](#) Introduction This page is about electronic drums. Here you will find detailed information on how to build an electronic Trigger to MIDI Converter module, based on PIC Microcontroller, and how to build the triggers. This project has been developed for many years now, and it..... Listed under: [Projects, Sound - Audio Projects](#)
2192.  [Repair of Arcam CD73 laser mechanism](#) This 2004 vintage Arcam CD73 came into us with the reported fault that it would no longer play CD's, or even read the table of contents. Given that it is over eight years old and had plenty of use in that time, we were not..... Listed under: [Video - Camera - Imaging Projects](#)
2193.  [Alchemist Forseti APD15A RC Integrated amplifier](#) We recently had a customer present this faulty Alchemist Forseti integrated amp for repair - I'd guess this dates from the 1990's and has been well looked after. It's a bit of a bruiser as you can see from the extensive heatsinking! Unfortunately it developed..... Listed under: [Sound - Audio Projects](#)
2194.  [MRNet - Wired Cab Module \(Revision A\) using pic microcontroller](#) Table of Contents Table of Contents Introduction Cab Design Goals Cab Electronics Power and Cable Interface Microcontroller Seven Segment Display Buttons LED's Cab Printed Circuit Board Cab Software Summary Introduction {Introduction goes here.} Cab Design Goals The goals for the handheld cab are: Light weight..... Listed under: [LED Projects](#)
2195.  [Infra red remote control tester for Philips RC5 protocol](#) Philips invented the RC5 protocol for controlling electronic equipment such as CD players, VCR's and audio amplifiers way back in the 1980's. The RC5 standard has been adopted and used with great success ever since, which means it is probably the most common IR remote..... Listed under: [LED Projects](#)
2196.  [LED Sign has a purpose! using pic microcontroller](#) The single character LED sign I had been playing with now has a purpose! Shortly after discarding several ideas of having it as a serial display for PC/Server status, or hooking it up to the internet and a webcam, I came up with an actual..... Listed under: [LED Projects](#)
2197.  [Interfacing VFD with PIC Microcontroller](#) Vacuum fluorescent display can be a good alternative to a Liquid-crystal displays in some applications. They have a number of advantages over LCD like extended temperature range and excellent contrast in high brightness environment. The main disadvantage is higher power consumption making them less attractive in..... Listed under: [LCD Projects](#)
2198.  [Serial communication with Pic 16f877 using UART](#) Abstract of that project: Using UART port we can establish serial communication between any devices. Here in my project Serial communication with Pic 16f877 using UART I will show you how easily we establish communication between two devices. In my project we know the pin..... Listed under: [Interfacing\(USB - RS232 - I2c -ISP\) Projects](#)
2199.  [Photomultiplier Tube \(PMT\) Controller Circuit B using pic-microcontrollerboard](#) The four channel PMT controller board is a PIC microcontroller based device that communicates with a PC by USB as an HID device and with a PIC-based "hand unit" via PIC-to-PIC RS-232 protocol. These two external inputs (USB and RS-232) send strings to the PMT..... Listed under: [Video - Camera - Imaging Projects](#)
2200. [Low power temperature data logger using PIC18F27J53](#) Design Goals DIY Friendly - Something that the Make audience could easily build Improve the reference design - Better measurement resolution, better timing, lower power, non-stop logging Minimal parts count - Lower cost and shorter build time Powered by a single 1.5 volt cell (AA,..... Listed under: [Projects, Temperature Measurement Projects](#)



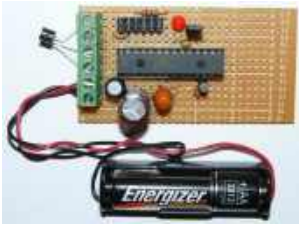

2201.



[Top Embedded Projects Ideas for Engineering Students](#) Embedded system An embedded system is designed to perform one function with real-time applications. Embedded systems are found in simple devices like calculators, microwave & television remote controls and also in more complicated devices such as a home security and neighborhood traffic control systems. Many..... Listed under: [Other Projects](#)

2202.



[FM RDS Tuner Module for mobile applications using PIC18F46k20](#) Stereo FM band receiver with RDS decoding for mobile applications. Continuous full RDS data output through RS232: RDS PS, PI, TA/TP/TMC, CT, TMC. Full Radio Text supported: 2x64 characters. Raw TMC data output. Low power operation with two AA (HR6) 1V2 Ni-Mh batteries or power..... Listed under: [Phone Projects](#), [Projects](#), [Radio Projects](#)

2203.



[Wireless UART](#) Wireless Infrared UART prototype can be built by using two PIC16F876A controllers. One as IR receiver with dedicated Infrared decoder like SFH505A, SFH506 or similar IR receiver IC and other microcontroller as a transmitter via IR LEDs. This is relatively simple design and doesn't require advance..... Listed under: [Wireless Projects](#)

2204.



[Zeus: trigger your camera with lightning using pic microcontoller](#) Introduction I have always been fascinated by photographs about lightnings. While it is relatively easily to put a lightning strike in any photograph using image editing techniques 😊 I still prefer the real thing. Since photography is a hobby of mine, I wanted to be..... Listed under: [Video - Camera - Imaging Projects](#)

2205.

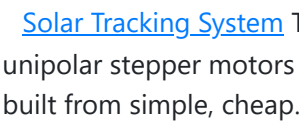

[Solar Tracking System](#) This is a simple PIC microcontroller based Solar Tracking system, only basic electronics skills are required. It uses 2 unipolar stepper motors and 4 IR-850nm LEDs as sensors to follow the sun maximizing solar panel illumination. The entire prototype frame was built from simple, cheap..... Listed under: [LED Projects](#), [Motor Projects](#)

2206.



[Universal Serial Infrared Receiver using PIC16F88](#) You can use this Universal Infrared Receiver (UIR) project to control your PC: Starting Windows programs, setting the Windows volume control, even moving the mouse around the screen! All at the touch of a button - with your TV remote control in fact! It uses a..... Listed under: [Internet - Ethernet - LAN Projects](#), [Projects](#)

2207.



[martin lightjockey 2 free](#) The new Martin Light Jockey II Lighting Software Kit is a new way to control your. LightJockey Manager is a free-of-charge software add-on for our LightJockey Page 2 the interface. In control panel, the USB interface is recognized as USB. A: I did test the..... Listed under: [LED Projects](#)

2208.



[pic microcontroller projects pdf](#) General.. Title: McGraw-Hill-PIC Microcontroller Project Book File size: 13. 4 MB Gene: E-Books Format: Pdf. Uploader: RedDragon. Pages: 220 Pages Abstract: This project outlines the strategy adopted for establishing two kinds of. The principle task of this project was to program the AVR microcontroller Commercial,..... Listed under: [Microcontroller Programmer Projects](#)

2209.

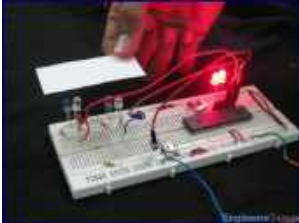

[PIC12F675 Comparator Code and Proteus Simulation](#) This post provides the comparator code for PIC12F675 microcontroller. As we know, PIC12F675 microcontroller has one built in op-amp, which can be used as comparator. This code is written in C language using MPLAB with HI-TECH C compiler. You can download this code from the 'Downloads' section..... Listed under: [Interfacing\(USB - RS232 - I2c -ISP\) Projects](#), [Projects](#)

2210.

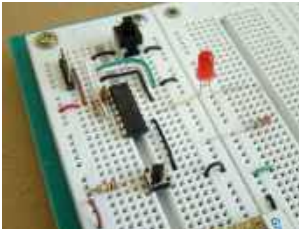

[Lab 2: Basic digital input and output](#) Description Today we will learn how to read digital inputs from a push button switch. A digital input has only two values: 1 and 0. The configuration of the push button switch is same as that of the reset switch except it goes to a..... Listed under: [LED Projects](#)

2211.

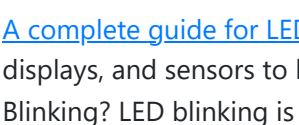

[A complete guide for LED Blinking](#) What is LED? A light-emitting diode (LED) is a semiconductor light source. LEDs have allowed new text, video displays, and sensors to be developed, while their high switching rates are also useful in advanced communications technology. What is LED Blinking? LED blinking is same as..... Listed under: [LED Projects](#)



2212.



[The PIC Elmer 160 Project Board using PIC16F628](#) Description -- What is the PIC-EL board and what can you do with it? Specification -- What features are on the PIC-EL project board? Schematic -- Circuit diagram on this web page or in PDF format Builders' Notes -- Check here for special tips or..... Listed under: [Development Board - Kits Projects](#), [Projects](#)

2213.



[Speed control of DC motor by PWM in Proteus simulation](#) Hello friends here is a proteus simulation of speed control of DC motor with the help of Pulse width modulation (PWM) control, PWM signals are generated by 8051 microcontroller. As we have discussed earlier that proteus is a really good simulation software for beginners and..... Listed under: [Motor Projects](#)

2214.



[Microdot – wrist watch LED pattern timepiece using PIC16F8 microcontroller](#) Microdot - wrist watch LED pattern timepiece Another RGB Sunset Productions production! This project is a circuit board for making a wrist watch size version of my minidot clock: <http://www.instructables.com/id/EEGLXQCSKIEP2876EE/> with a few more functions more applicable to a portable device. A lot of help..... Listed under: [Development Board - Kits Projects](#), [LED Projects](#), [Projects](#)

2215.

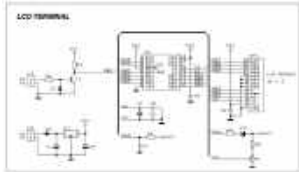

[Easy Debugging Terminal using pic microcontroller](#) Build a simple 9600 BAUD 8n1 LCD terminal for debugging and testing the projects having RS232C output. Introduction This LCD terminal provide two modes of operation by selecting jumper J1. When J1 is open the terminal operate as a normal ascii display terminal, when J1..... Listed under: [LCD Projects](#)

2216.

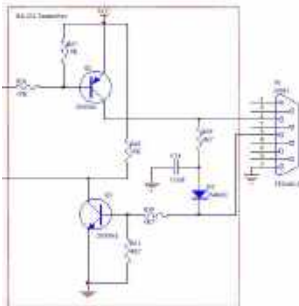

[TTL to RS232 Signal Conversion](#) Methods: Use a TTL HI output for the RS232 GND: Steve Walz of armory.com says "Use a TTL HI output for the RS232 \*GROUND\*!! Then you get +/-5VDC levels to fake out the RS232. When TTL-GND goes HI, then a TTL-XMT LO looks like -5VDC..... Listed under: [Interfacing\(USB - RS232 - I2c -ISP\) Projects](#)

2217.



[The chipKIT™ UNO32™ and MAX32™ development boards for the Arduino™ Community](#) Microchip Technology Inc., a leading provider of microcontroller, analog and Flash-IP solutions, and Digilent, Inc. announced expanded capabilities for the 32-bit PIC32 microcontroller-based chipKIT™ Development Platform for the Arduino™ community. The chipKIT development platform is a 32-bit Arduino solution that enables hobbyists and academics to..... Listed under: [chipKIT Projects](#), [Development Board - Kits Projects](#)

2218.



[A pic programmer circuit based on AN589](#) AN589 is microchip's application note for a parallel port pic programmer circuit which I chose as I wanted something reliable to get up and running quickly. It is really quite a simple circuit and its main objective is to provide ICSP connections to your pic..... Listed under: [Microcontroller Programmer Projects](#), [Projects](#)

2219.



[Application of Microcontroller in Science and Technology](#) The rapid growth in science and technology offers several advantages of using integrated circuits, microprocessors, microcontrollers, embedded chips, etc., in designing electrical and electronics projects and circuits by reducing their size, cost, and complexity. Using these embedded chips and microcontrollers is increasing due to its..... Listed under: [Robotics - Automation Projects](#)

2220.



[PIC Projects using pic microcontroller](#) Some of the various PICs from Microchip, 16F84, 16F627, 16F628, 16F876 and a 16F877. So far, I have only played around with the PIC16F84 PIC chip, with exception to using a PIC16F876 with the HamHUD. I have found the most documentation is on the 16F84..... Listed under: [LED Projects](#)

2221.



[How to build a speed detector for a coilgun project](#) If you are building a coilgun (or gauss gun) or rail gun, a necessary part of your project will likely be some sort of speed detector. Getting a coilgun to work is rewarding, but you can't continue the project without a reliable, accurate device to..... Listed under: [Development Board - Kits Projects](#), [Projects](#)

2222.

[5 transistor PIC programmer \\*Schematic added to step 9!](#) Make your own PIC programmer for your computer's parallel port. This is a variation of David Tait's classic design. It is very reliable and there is good programming software available for free. I like IC-Prog and PICpgm programmer. Best of all, it uses just two..... Listed under: [Microcontroller Programmer Projects](#)





2223.



[PlayPIC – A Tutorial Board for the PIC16F84A Microcontroller](#) This is a new design of a tutorial board based on the popular PIC16F84A microcontroller. It features eight single leds, a 7-segment display, an LCD display and five push buttons. It is an ideal solution for the beginner to take his/her first programming steps in..... Listed under: [LCD Projects](#)

2224.

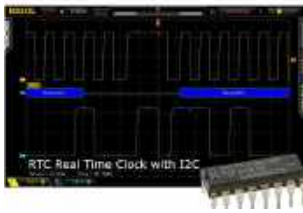

[PCF8573P I2C Real Time Clock](#) In this post I'm going to show you how to interface an I2C Real Time Clock – RTC with PIC microcontroller. Only a basic hardware configuration and a communication protocol are presented here. I'm planning to extend it to a more advanced design in a..... Listed under: [Clock and Timer Projects](#)

2225.



[F84-Programmer using pic microcontroller](#) Build a low-cost and very simple serial programmer for a PIC16F84 Microchip Flash Microcontroller. Below picture is my personal writer for F84 chip, it works very nice with Nigel WPicProg V1.20. Introduction I finally found a very nice universal window based software designed to work..... Listed under: [Microcontroller Programmer Projects](#)

2226.

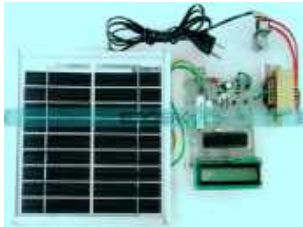

[PIC Microcontroller Projects for Final Year Engineering Students](#) The abbreviation of PIC is the "Peripheral Interface Controller", and it is a family of the microcontroller. This microcontroller is manufactured by various companies like the microchip, NXP etc. This microcontroller comprises Analog to digital converters, memories, timers/counters, serial communication and interrupts assembled into a..... Listed under: [Microcontroller Programmer Projects](#)

2227.

[Stepper Motor Interface PIC16F](#) Here is a simple example for PIC microcontroller interfacing Unipolar stepping motor with assembly code. Instead of using a dedicated stepper motor driver IC like very popular L293D PIC16F with ULN2003A were used. Just 4 I/O Pins are required to drive each coil of the motor. By..... Listed under: [Motor Projects](#)

2228.



[Single-Axis PIC Controlled Solar Tracker DIY Kit](#) Hi All I'm not going into as much depth with this instructable due to my current time constraints. That said, I fully plan on updating this instructable as time progresses with new algorithms and programs for optimization. Intro: I was messing around with some new..... Listed under: [Sensor - Transducer - Detector Projects](#)

2229.



[Serial LCD project using PIC16F877A Microcontroller](#) This project shows you how to create a serial LCD module that you can drive from any serial RS232 interface. It uses a pure ASCII command set so you can control it easily from a terminal program such as Hyperterminal. There are no 'odd' command sequences..... Listed under: [LCD Projects, Projects](#)

2230.



[PIC Waveform Recorder](#) In this article I'll show you how you can use PIC microcontroller to record and store waveform patterns in its EEPROM memory and replay the sequence later. For this purpose we'll need a signal/waveform generator to produce the signal, PIC internal A/D converter to sample..... Listed under: [LCD Projects](#)

2231.



[LED FX using PIC12F629 Microcontroller](#) This project produces a number of effects on a set of three LEDs. You can also produce your own sequence and store it by using the 3 buttons. You can build the project on Matrix Board or buy a complete kit with pre-programmed chip. You..... Listed under: [LED Projects, Projects](#)

2232.



[HC08 Fan Timer using pic microcontroller](#) Build a timer with Motorola Nitron MCU and using ICC08 to develop c program. Loader schematic also included. New s-record for 8-pin 68HC908QT2! My son got his fan in the bedroom. The fan has mechanical timer for 0-180mins. One day it broken. So I got..... Listed under: [Clock and Timer Projects](#)

2233.



[Top PIC Microcontroller Projects Ideas](#) When we are choosing PIC microcontrollers for projects on electronics or electrical, there are many options for us. Ranging from eight bit to Thirty two bits, diverse micro-controllers are accessible to go well with projects and products of different complications and cost restraints. But if..... Listed under: [Temperature Measurement Projects](#)

2234. [PIC Microcontroller Basics and Applications for Engineering Students](#) The microcontrollers plays an essential role in the embedded industry after the development of Intel 8051. The research in the field of embedded industry gave high efficient, low power consumption



microcontrollers. The Arm, AVR and PIC microcontrollers are the prime examples. These microcontrollers are getting..... Listed under: [LCD Projects](#), [LED Projects](#)

2235.



[Power MOSFET RGB LED PWM Driver for PIC12F683](#) Description Since I published the original RGB LED driver (photo right) I've had many enquiries from people asking how they could make the original board work with more LEDs. I'd already made a couple of custom boards up for myself, so I finally decided it..... Listed under: [LED Projects](#), [Projects](#), [PWM Projects](#)

2236.

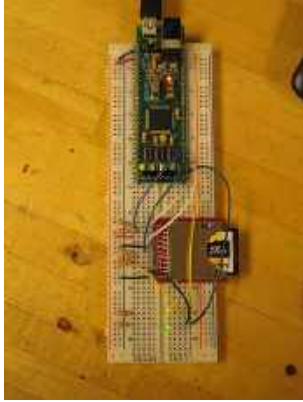

[PIC32MX: Interfacing to a Secure Digital \(SD\) Flash Card](#) Original Assignment Do not erase this section! Your assignment is to create code that will allow the PIC32 to read and write data to a FAT32 SD card. The SD card should be able to be read by a PC after data has been written..... Listed under: [Interfacing\(USB - RS232 - I2c -ISP\) Projects](#)

2237.



[Remote controlled LED lighting effects](#) LED's have become most important component in lighting industry due to its miniature size and less power consumption. Also LED lights are lot more attractive than the primitive lights used once. This project focused on building an remote controlled LED with multiple lighting effects. Imagine..... Listed under: [LED Projects](#)

2238.



Real Time Clock IC

[Real Time Clock \(RTC\) Interfacing PIC18F](#) Introduction to RTC: Real time clock also referred as RTC is an important device or integrated circuit which will keep the track of current time. RTC is mainly used in computers, mainframes servers and embedded applications (mobile phone, tablets, organizers, PDA etc). The main function..... Listed under: [Clock and Timer Projects](#)

2239.

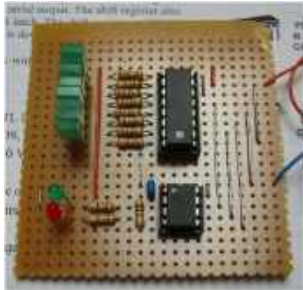

[Test For Presence of Internal Oscillator Calibration Word for PIC12F629](#) Description The PIC 12F629 and 12F675 devices have an internal 4Mhz oscillator that enables the devices to be used without an external crystal or RC network. This frees up one or two pins for I/O use and allows the device to be built into minimum..... Listed under: [Clock and Timer Projects](#), [LED Projects](#)

2240.

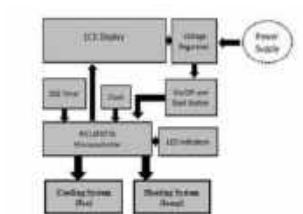

[Green house intelligent control system](#) In this post we will discuss about Green house intelligent control system: With the people's living standards increasing, modern, a large number of agricultural production, such as vegetable using greenhouse to cultivate. The temperature and humidity monitoring are two key factors which used to control..... Listed under: [Temperature Measurement Projects](#)

2241.



[My New MIDI Merger uses 10 MIPS £1.00 PIC Microcontroller using PIC18F4320](#) This unit provides 4 autonomous MIDI inputs and 1 MIDI output. Note this is a 'proper' MIDI Merger – all 4 MIDI inputs can be used at the same time, unlike other 'designs'. The unit also provides an indication of the channel number being played,..... Listed under: [Interfacing\(USB - RS232 - I2c -ISP\) Projects](#), [Projects](#)

2242.



[WLoader – a 16f877 application loader using pic microcontroller](#) If the piclist is an any indication the 16f877 seems to be the new favorite hobby microcontroller, a position that used to be occupied by the 16f84/16c84. Compared to is older brethren the 16f877 has much more to offer at around twice the price. As..... Listed under: [Microcontroller Programmer Projects](#)

2243.



[Emergency Vehicle LED Light](#) Described here is a low-component count Emergency Vehicle LED Light circuit which can be used for capturing the attention of (or warning) drivers and pedestrians. These type of lighting gadgets kindle an instant response that makes people look up and pay attention -an important consideration..... Listed under: [LED Projects](#)

2244.

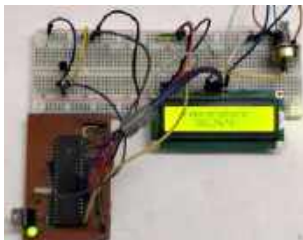

[Digital Thermometer using pic microcontroller and MCP9700](#) In this article you will learn, Digital Thermometer using pic microcontroller and MCP9700: [caption id="attachment\_22217" align="alignnone" width="300"] Digital Thermometer using LM35 and PIC microcontroller[/caption] In this tutorial, we are making a Digital Thermometer using PIC microcontroller and LM35 Temperature Sensor. In this project, we will sense..... Listed under: [LCD Projects](#)

2245.

[PIC microcontroller led flasher circuit using PIC16F627A](#) This is microcontroller led flasher circuit using PIC16F627A as first PIC microcontroller learning of mine son. it is basic for really beginner. Important issue,we have to make The PIC micro controller is easier. Children 8 years old, he does not understand the computer language at..... Listed under: [LED Projects](#)





2246.  [F84 Miniature Real-Time Controller](#) Build a simple real-time controller with PIC16F84 running at low power X-tal 32,768Hz. Daily scheduler for 6-channel resides in 64-byte EEPROM can easily be preprogrammed using Nigel PicProg. RTC2.C provides user programmable set current time without the need of recompilation. Fixed bug on minute conversion!..... Listed under: [LED Projects](#)



2247. [PIC MICROCONTROLLER PROJECTS AND LCD CIRCUITS](#) Here is 0 to 99 minutes relay timer using PIC16F628 microcontroller and 16 character LCD display. The microcontroller is PIC16F628A running at 4.0 MHz clock using an external crystal. An HD44780 based 16x2 character LCD is the main display unit of the project where..... Listed under: [LCD Projects](#)



2248. [Generic Automotive Light Effect PIC/Arduino Modules](#) These are simple modules I made with a pic 12c508 microcontroller. I use them to create different effects. The Mosfets are capable of some decent current with very little heating. I have used these for sequential turn signals, flashing brake lights, alternating flashers, strobe effects..... Listed under: [LED Projects](#)

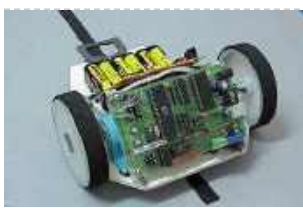

2249. [C-52EVBRobot Controller](#) Use a C-52 EVB for simple robot experiments. Build a simple two wheels robot with L293D H-Bridge driver and IR sensors. Write a C program controls robot tracked with black tape. Fun with Ving-Peaw Competition 2543, course layout, day-by-day changed rule and scoring also included! Introduction One of..... Listed under: [Robotics - Automation Projects](#)



2250. [Making a 8x40 LED matrix marquee using shift registers](#) LED matrix displays provide flexibility to display text, graphics, animations, and video, and therefore, they have become a popular mean of displaying information these days. You can see them at gas stations displaying the gas prices, or in the public places displaying information, and alongside..... Listed under: [LED Projects](#)

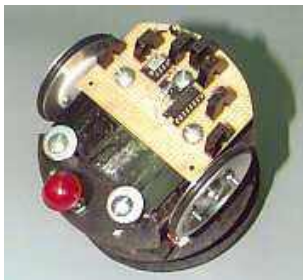

2251. [JavaBot1..... A line following robot](#) Design Goal: The JavaBot1 is a small line following robot designed to follow a black line drawn on a dry erase board. It is designed to follow very tight curves. The software still has a lot of room for improvement but works well as is..... Listed under: [Robotics - Automation Projects](#)



2252. [Emergency Excuse Generator using PIC16F690](#) This device is a must-have for any respected professional. Any time the need arises, you will have an original, freshly-generated excuse ready in seconds. One press of the button can get you out of a tight spot ensuring smooth sailing toward retirement and guaranteeing that..... Listed under: [Other Projects](#), [Projects](#)











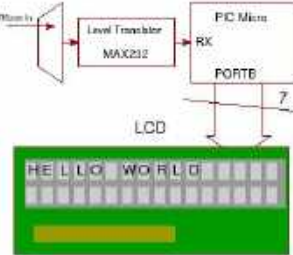

2253. [LED scrolling Christmas tree ornament with built in video game!](#) Hello all and welcome to this Christmas tree decoration instructable. This ornament is designed to hang on your Christmas tree just like any other decoration, but it's just that little bit more eye catching! When you turn it on it will scroll a "MERRY CHRISTMAS" message..... Listed under: [LED Projects](#)

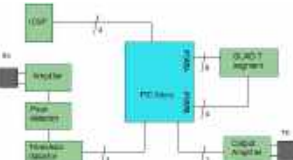

2254. [MIDI-Controlled Analog Music Synthesizer](#) For my electrical engineering senior design project, I decided on designing an analog music synthesizer with MIDI control. I have to admit, this was what I wanted to do since high school and was my ultimate goal as a musician, artist, DIY person, and engineer..... Listed under: [Sound - Audio Projects](#)



2255. [Making a mini LED Christmas tree](#) My two and a half year old son loves toys with flashing lights. For this Christmas I thought of making a mini LED Christmas tree for him. This project uses 22 multi-color LEDs which are driven by a PIC12F683 microcontroller using the Charlieplexing technique. The..... Listed under: [LED Projects](#)

2256.  [A PIC Serial LCD Project](#) [advanced\_iframe securitykey="7053122eaa09ce46830dfb8aaeae454056003ad0"] [advanced\_iframe securitykey="7053122eaa09ce46830dfb8aaeae454056003ad0"] This project shows you how to create a serial LCD module that you can drive from any serial RS232 interface. You may be asking yourself why is this project using RS232 when computers are no longer even produced with a serial port as standard?..... Listed under: [LCD Projects](#)
- 
2257.  [The Glowing Green Robot](#) Robots look cooler when they have a sinister green glow. Better yet, when that glow exists for a functional purpose it's even better! Here I show how to make a custom robot and use LED's to not only enhance line following, but also make it..... Listed under: [Robotics - Automation Projects](#)
- 
2258.  [Echo Mp3 DIY Audio player using PIC18F46K20](#) The EchoMp3 is a small DIY\* Audio player. Mp3, Wav, Ogg-Vorbis, Wma and Mid formats are supported. 4, 8, 16 GB SDHC cards used as storage. FAT (FAT16) and FAT32 supported. Low power operation with two AA (HR6) 1V2 Ni-Mh batteries. Power input range is..... Listed under: [How To - DIY - Projects](#), [Projects](#), [Sound - Audio Projects](#)
- 
2259.  [A PIC Ultrasonic distance meter project using a Seven Segment display and a PIC micro.](#) The PIC Ultrasonic distance meter works by transmitting a short pulse of sound at a frequency inaudible to the ear (ultrasonic sound or ultrasound). Afterwards the microcontroller listens for an echo. The time from transmission to echo reception lets you calculate the distance from the..... Listed under: [LCD Projects](#)
- 
2260.  [The Rock](#) This robot is controlled by a visual basic program (through the serial port), and can move in three different velocities by a pulse width modulated (PWM) signal generated by a PIC microcontroller (16F877). The robot can be operated in two modes, "normal control" and "light..... Listed under: [Robotics - Automation Projects](#)
- 
2261.  [Aurora 9x18 Kit](#) \*\*\* There's an updated version of this kit available at <http://www.theledart.com/blog/store> \*\*\* Responding to many requests, Aurora 9x18 Kit is now available, so this is the Instructable specific to building the kit. Please leave comments, especially tips for successful assembly. Step 1: Identify the Parts First, identify..... Listed under: [LED Projects](#)
- 
2262.  [Analog Experiments Anywhere](#) Two DIY micro-controller based USB connected electronic units which along with the Texas Instruments Analog System Lab Starter kit and a laptop permit you to conduct analog experiments anywhere. It would be wonderful if senior students and laboratory supervisors built these units so that they..... Listed under: [Interfacing\(USB - RS232 - I2c -ISP\) Projects](#)
- 
2263.  [Serial LCD Controller](#) I discovered a flaw in the current design that will only allow the controller to work with a connection to the computer and not to a microcontroller. I've updated the schematic below and will fix the controller design. I've added a project file below that..... Listed under: [LCD Projects](#)
- 
2264.  [How to Create a Beer Bottle LED VU Meter](#) Create your own Beer Bottle LED Volume Unit Meter! This instructable will show you how to create a LED beer bottle VU Meter. A volume unit meter is a device that is used to display a relative volume of audio signals. Basically, sound gets converted..... Listed under: [LED Projects](#)
- 
2265.  [Cheap and Easy Dial Controlled High Power RGB LED\(s\) Driver](#) There may be a lot of RGB LED Drivers out there, but this one is a bit different, its versatile, small, cheap, and is simple to control. A potentiometer with built in switch is used for the controls. A quick press, switches between color cycling and..... Listed under: [LED Projects](#)
- 
2266.  [Microchip PIC16F877 Microcontroller](#) Table of Contents Introduction 1.1 What is a Microcontroller? 1.2 Why are Microcontrollers used? 2 Getting started 2.1 Parts list and vendors 2.2 Connecting the equipment 3 PIC16F877 Microcontroller 3.1 Flash PIC development board 3.2 CCS PIC-C compiler 3.3 In Circuit Debugger/Programmer (ICD-S) 3.4 Embedded..... Listed under: [LED Projects](#)
- 
2267. [Pimp my Pong](#) I get wind of this Think Geek hacks contest, a week late, frantically, I hit thinkgeek.com looking for a easy kill, budget and ideas both turn up empty. What about that pong kit I bought from them ~2 years ago? ... hm when i first..... Listed under: [Development Board - Kits](#)



[Projects](#)

2268.



[TTPSU – Power supply for turntables with AC motors](#) The power supply described here, is for turntables with 2 phase AC motor, like Linn, Rega, AR, Heybrook, Goldring and many, many more. The main features of the power supply are: X-tal controlled speed. The TTPSU can change speed by the push of a button..... Listed under: [LCD Projects](#)

2269.



[Arduino solar charge controller + output control and data logging online with Xbee WiFi](#) A while back I started working on a solar charge controller, it was based on a PIC microcontroller, a 20x4 characters display and the code was written in Assembly language. It did work well and was still working when I decided I wanted to add..... Listed under: [LCD Projects](#)

2270.



[LED LYT Meter: LED, PIC Microcontroller, and Moving Average Code](#) Hello everyone, thank you for checking out my first Instructable. I have enjoyed seeing your creations over the years and love what all of you are contributing. This project is a spin off of one that I recently saw here and I need to give a shout out to..... Listed under: [Metering - Instrument Projects](#)

2271.



[Vehicle security with GSM](#) The main aim of making GSM Based Vehicle Theft Alert System is to apply the electronic theories, modern security methods, embedded system, and modem age of science and technology for many kinds of transport machine. Moreover this GSM Based theft Alert System can reduce cost,..... Listed under: [LCD Projects](#)

2272.



[Leon's Mini Random Number Generator \(mRNG\) using pic microcontroller](#) Sales Pitch Are you confused by choices? Who isn't? There are just so many things to decide. White, rye, or wheat? Pinstripes or polka dots? Feast or fast? Well, don't worry because help is on the way! I'm introducing the world's first, portable, hand held,..... Listed under: [LED Projects](#)

2273.



[BlinkLED](#) A BlinkLED is a LED that has its own PIC microcontroller. Blink patterns and blink rates are programmable and BlinkLEDs can be used individually (for LED Throwies) or in strings for holiday or special lighting. I made these because I wanted to trim my Christmas tree..... Listed under: [LED Projects](#)

2274.



[RGB LED Color Cycling Circuit](#) How to re purpose a the RGB LED color cycling circuitry from a Glade LightShow air freshener. I was in the process of creating a red, green , blue color cycling circuit based on a PIC microcontroller when I spotted the Glade LightShow air freshener..... Listed under: [LED Projects](#)

2275.



[Mirror "Tube" – LED Optical illusion](#) One day, looking for interesting schemes with light effects to construct, came across this wonderful effect. Quite liked the idea but did not know how to accomplish is, until one day found the way. Subsequently construct my own mirror that had to not only try..... Listed under: [LED Projects](#)

2276. [One-chip sound player.](#) The purpose of this project was to create a sound player that can play high quality sound using nothing but a single chip (plus an SD card for data storage). The chosen microcontroller was the PIC12F1840. It was chosen because of its fast clock rate..... Listed

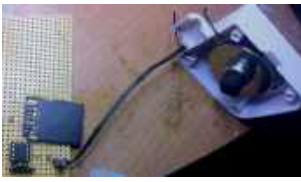

under: [Sound - Audio Projects](#)

2277.



[Interactive LED Beer Pong Table 2.0 \(BPT X5\)](#) The nice thing about building one of these tables from a kit is that the more difficult parts of the project have been completed (Electronic Design, PCBs made, etc.) but more importantly, you can fully customize the table to your liking. The photos that I..... Listed under: [LED Projects](#)

2278.

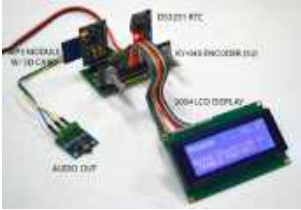

[An "Antique Radio" Christmas Present](#) I happen to be part of the 5% that have the elusive awesome mother-in-law. For Christmas I wanted to make her an "antique radio" that is super simple to operate and that could play some "old time radio" type programming that she listened to when..... Listed under: [LCD Projects](#)

2279.



[Remote Control mood light\[/jar\]](#) I wanted to play around with something IR remote-controlled, so I decided to make a remote-control mood light. There were two parts to the project: making the remote and making the light. For the remote, I tore down a remote control for a floor fan,..... Listed under: [LED Projects](#)

2280.



[How to Create an Eye Catching Display \(LED Style\)](#) This is not as much an instructable as a record of how I made a school project. While repeating exactly what I did will probably not help you, this project can be modified to make almost any display more eye-catching. Step 1: Come up..... Listed under: [LED Projects](#)

2281.



[Xbee Wireless Servo Control using PIC18LF4520](#) Searching for a reliable wireless solution for your project can be a real pain if you're not familiar with current wireless standards, data rates and reliability. The Xbee Modules that we will use in this article are widely available, use a very reliable wireless transmission..... Listed under: [Motor Projects](#), [Projects](#)

2282.



[Computer Controlled Star](#) In this instructable I am going to show you how to build a Star with 64 LEDs. The Star operates by itself but the operation mode can be changed when connecting it to a computer via a serial (RS232) interface. After reconfiguring the Star via..... Listed under: [LED Projects](#)

2283.



[Data logging with an EEPROM](#) Contents 1 Original Assignment 2 Overview 3 Circuit 4 Code 4.1 PIC Code 4.2 Matlab Code 5 Example Output 6 Further Reading Original Assignment Your task is to use the PIC to log data from an analog input on an EEPROM, and after the..... Listed under: [Interfacing\(USB - RS232 - I2c -ISP\) Projects](#)

2284.



[Arduino controlled light dimmer](#) WARNING: Some people try to build this with an optocoupler with zerocrossing coz 'that is better' right? Some are even told in electronics shops it is better to use such an optocoupler. WRONG. This will only work with a random fire optocoupler: NOT igniting at..... Listed under: [LED Projects](#)

2285. [Andy Robison's Lab Notebook using pic microcontroller](#) Week 01 January 14 (2 hours): Met as a team after class to discuss preliminary project proposal. January 15, 2010 (1 hours): Met as a team to discuss design implementation and assign different components to research. WEEK 01 SUMMARY Accomplishments: Submitted preliminary project proposal. Weekly..... Listed under: [LCD Projects](#)





2286. [Cheap Easy Solar Powered Robot](#) Make a very cheap, relatively easy to construct robot which will wake up any time you shine a desk lamp on it. There are no sensors on it, although I suppose the solar panel can be called a sensor. I plan on adding solar panels..... Listed under: [Robotics - Automation Projects](#)



2287. [RC5/RC6 codes on a LCD using PIC16F648A](#) A simple project to test and display the transmitted codes from remote controls which work with the RC5 protocol, like the TV remotes from Philips, just aim the remote control at the TSOP1736 IR-receiver. If you only want to know the code from a button..... Listed under: [LCD Projects](#), [Projects](#)



2288. [Towers of Hanoi Final report using pic-microcontroller](#) Abstract: We have developed a mechatronic system to solve the famous Tower of Hanoi problem as part of a Carnegie Mellon University class. This class seeks solutions which solve the problem in under three minutes for the four disk case, using only the number of..... Listed under: [Development Board - Kits Projects](#)

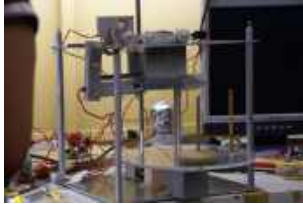

2289. [Aurora 9x18 RGB LED art](#) \*\*\* Check out my blog for updated version of this project and more! \*\*\* My obsession of LEDs has led me to this. Aurora 9x18 is a thing of beauty (if I can say so myself) - has 162 RGB-LEDs in a circular configuration. The..... Listed under: [LED Projects](#)

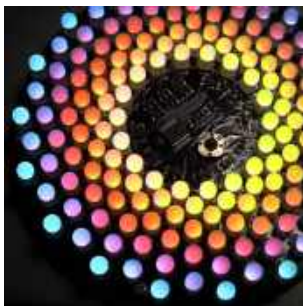

2290. [CS2200 Intro to Systems and Networks using pic-microcontroller](#), Download the project by clicking here. The zip file contains all the following files: prj1.html - You're reading it - contains the project description Assembler assemble16-win32.exe - a Windows-compiled HEX assembler to convert your assembly code to HEX for your RAM. assemble16-linux.c - source code..... Listed under: [Internet - Ethernet - LAN Projects](#)

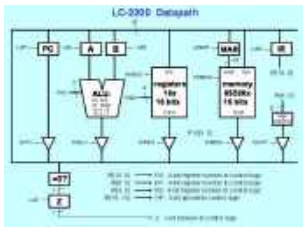

2291. [eLab Hackerspace GSM Access Control System](#) In this Instructable we'll show you how to make a GSM Access Control System for your hackerspace/garage/house/bedroom/dormroom/laboratory just like the one we built for eLab Hackerspace. We only used some scavenged parts but they can be replaced with similar parts with minor changes. This system..... Listed under: [Phone Projects](#)



2292. [PIC MCUs: Hardware and Connections using pic-microcontroller](#) Required Hardware In order to program and debug a PIC microcontroller, you will need a few pieces of hardware. ICD-U40 The ICD-U40 is an In-Circuit-Debugger/Programmer that allows the user, through CCS C Windows IDE, to program and interactively debug a PIC microcontroller. 5V DC Power..... Listed under: [Interfacing\(USB - RS232 - I2c -ISP\) Projects](#)



2293. [Lucid Dream/Dream Recall Machine using infrared.](#) This is my first instructable, so I hope everything is clear and hoping you find it interesting, and would appreciate any feedback, so here I go. I am still testing this device with other people, but personally I have found my dream recall has improved dramatically..... Listed under: [LED Projects](#)



2294. [USB Keypad Demonstration – Crystal Free USB and mTouch™ Sensing Solutions using pic microcontroller](#) The USB keypad reference design demonstrates crystal free USB operation. Microchip has partnered with Lumvatech to demonstrate a low-cost aesthetic design, with touch capability and LED lighting integrated. All features are driven with a single PIC16F1459 MCU. USB is one of the most common serial..... Listed under: [Interfacing\(USB - RS232 - I2c -ISP\) Projects](#)









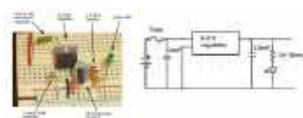

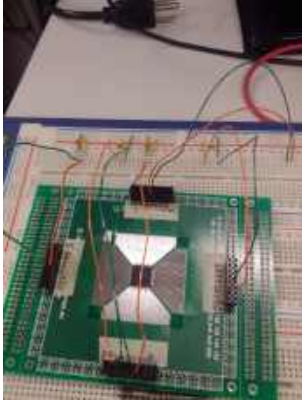
2295. [The ChromoDisk](#) When I saw the Aurora LED 9x18 Instructable, I was inspired. However, it's built on the PIC microcontroller while I am most familiar with the AVR microcontrollers. Plus, I already have the development and programming environments for AVRs, so I set about a redesign as..... Listed under: [LED Projects](#)

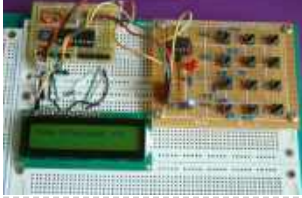

2296. [CSCI 255 Lab using pic-microcontroller](#) Preparation In addition to the power supply that you created on your breadboard in Lab 2, you will need the following equipment/components to complete your PIC prototype board: (1) multimeter (1) PIC 24HJ32GP202 chip (2) alligator clip leads (1) LED (1) 1K Ohm resistor (1)..... Listed under: [Home Automation Projects](#), [Metering - Instrument Projects](#)



2297.  [Semi-Automatic NERF Longshot](#) The first question I often get about this creation is "Why?." The answer is quite simple, I am an engineering student at Stony Brook University. We play a game on campus called "Humans vs. Zombies." That fact coupled with my over competitiveness, and my drive..... Listed under: [Game - Entertainment Projects](#)
- 
2298.  [Joshua Marchi's Lab Notebook using pic microcontoller](#) Week 01 January 11, 2012 (1 hour): Met with professor Talavage to discuss the basic functionality of the headset sensor devices that will be used to collect data for this project. Discussed challenges of interfacing these devices to the base station using the USB protocol..... Listed under: [Interfacing\(USB - RS232 - I2c -ISP\) Projects](#)
- 
2299.  [RFID Car immobiliser with PIC12629](#) Ok, so there are heaps of immobilisers out there but with most of them, if someone has your keys, they have you car. What good is a car alarm with 3+ point immobilisation if someone manages to get the keys and of course the alarm remote..... Listed under: [RFID - NFC Projects](#)
- 
2300.  [Hacking the Xbox CONTROLLER](#) In this tutorial I show you step-by-step how I install a PIC microcontroller inside of an Xbox controller in order to provide custom functions. Now that you have the methods, all you have to do is go write some code and program a chip! Well,..... Listed under: [Game - Entertainment Projects](#)
- 
2301.  [NES Controller iPod Remote](#) By embedding a PIC microcontroller into an NES controller, it can be converted into a replacement for Apple's iPod remote. (Only 3rd and 4th Generation iPods have this, it is a the small oval port next to the headphone jack). Update (8/26/2011): It's been quite..... Listed under: [Development Board - Kits Projects](#)
- 
2302.  [2-Wire Keypad Interface Using a 555 Timer using pic microcontoller](#) Keypads are a very commonly used input device in microcontroller-based systems. In a keypad, multiple switches are arranged in rows and columns so that they could be interfaced to a microcontroller with a minimum number of I/O pins. For example, a 12-key keypad is arranged..... Listed under: [Interfacing\(USB - RS232 - I2c -ISP\) Projects](#)
- 
2303.  [Crossed IR Beam Camera/Flash Trigger](#) This device will trigger a camera or flash unit to automatically take a picture when an object (target) enters a specific location. It uses two, crossed infrared light beams to detect the presence of the target and close a relay that trips the camera or..... Listed under: [Video - Camera - Imaging Projects](#)
- 
2304.  [GSM Voice Dialer with Automation Control using PIC18F46K20-I/PT](#) Connected to a burglar alarm or fire alarm in the event of making phone calls playing voice messages. Controlled via DTMF actuators can operate on the spot. In recent years we have introduced several telecontrols based on the SIM900 GSM module. We released schematics and..... Listed under: [Home Automation Projects](#), [Phone Projects](#), [Projects](#)
- 
2305.  [Nixie Tube Ornament](#) The Nixie Tube Ornament is a homage to the light-up&motion ornaments from the early 90's. The ornament looks cool on a tree and makes a great gift. Finally, a use for IN-12/15 top view tubes! I used an IN-15A symbol nixie in this ornament. An..... Listed under: [power - energy projects](#)
- 
2306.  [MikroElektronika's "Ready for PIC" board talks to "Processing" using pic microcontoller](#) "Ready for PIC" is one of MikroElektronika's compact prototyping boards for 28 and 40 pin PIC microcontrollers. The board comes with PIC16F887 microcontroller which is preprogrammed with an UART bootloader firmware and thus eliminates the need of an external programmer. The on-board USB-UART module allows..... Listed under: [LED Projects](#)
- 
2307. [Connecting multiple tact switches on a single input pin of a microcontroller](#) Normally one tact switch requires one digital input pin of a microcontroller. Some designs implement keypad style multiplexing to get multiple switches on fewer inputs. However, there exist other techniques that allow you to connect many switches on a single input pin of a microcontroller..... Listed under: [LED Projects](#)
-



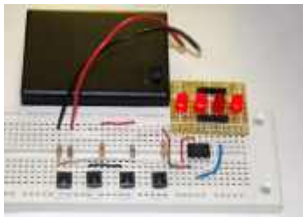

2308.



[Multimeter Clock](#) The Multimeter Clock consists of three multimeters, the first meter displays hours, the second displays minutes and the last displays seconds. A 16F628A PIC microcontroller keeps track of time and outputs a calculated current to each meter to display the current time. Get your own..... Listed under: [Clock and Timer Projects](#)

2309.



[Expanding the number of I/O lines using Microchip MCP23008 using pic microcontoller](#) A microcontroller comes with a limited number of general purpose input and output (GPIO) ports. However, some applications may require more ports than are available on the microcontroller. In such a case, GPIO expanders can be used to increase the I/O capability of the microcontroller..... Listed under: [LED Projects](#)

2310.



[Updated PIC 18F4550 USB Demo Board Video](#) In this video we step through a an updated version of the USB demo board. Changes include: -circuit board will only contain bare minimum parts to demonstrate USB communication from host to device and device to host -for both firmware and host software, we will..... Listed under: [Development Board - Kits Projects](#), [Interfacing\(USB - RS232 - I2c -ISP\) Projects](#), [Projects](#)

2311.



[The Most Useless Machine EVER!](#) And yet everyone wants one!!!? AKA: The Ultimate Machine! Get Your Useless Machine: Purchase Useless Machine Kits Here! Update Oct 31, 2012: "Weird AI" Yankovic Sez: "I never realized till now how much I needed one of these." AS SEEN ON TV! Make Magazine's amiable..... Listed under: [Video - Camera - Imaging Projects](#)

2312.

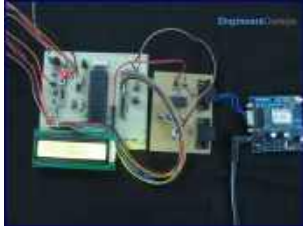

[How to interface GPS with PIC18F4550 Microcontroller](#) Global Positioning System is based on satellite navigation technology. A GPS Receiver provides the accurate location of an object in terms of latitude and longitude. Accurate time calculation with respect to GMT can also be done by using GPS. For more information on different data..... Listed under: [GPS Based Projects](#), [How To - DIY - Projects](#), [Projects](#), [Tutorials](#)

2313.



[SPI to 4 x UART Bridge \(MULTIUART\)](#) If your a fan of electronics then you like me will often find it annoying on the lack of hardware serial ports on modern devices. Many modules like the Wifi ESP8266 and the Bluetooth HC-06 are available for peanuts but they each require a UART..... Listed under: [Internet - Ethernet - LAN Projects](#)

2314.



[About the Temperature Sensor using pic microcontoller](#) Temperature sensors are used in a wide range of electronic devices, including digital thermometers, home thermostats, ovens, and refrigerators. Figure 1 shows two devices with temperature sensors. Figure 1. Devices with temperature sensors. The temperature sensor provided in your kit is a precision analog sensor,..... Listed under: [Sensor - Transducer - Detector Projects](#), [Temperature Measurement Projects](#)

2315.



[Steam Turret Tank R/C PIC Servo Controller](#) A Microchip PIC based servo controller offering many of the capabilities of digital servos for under \$9! The controllers capture the r/c receiver output, optionally manipulate the samples, then regenerate new servo control signals. As such, they greatly enhance what is possible with cheap servos..... Listed under: [Other Projects](#)

2316.



[OSOMCOM POCSAG BTS using pic microcontoller](#) The BTS or Base Transmitter Station is the device that transmit the POCSAG messages to the pager. It is the radio interface of the POCSAG network. THE HARDWARE The current version of the BTS hardware is a small board with a pic 18F microcontroller with..... Listed under: [Interfacing\(USB - RS232 - I2c -ISP\) Projects](#)

2317.













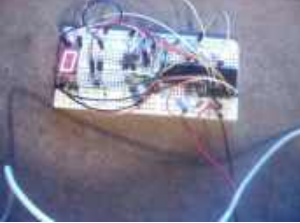

[Mini AV Test Box using pic microcontoller](#) The notion of building a monitor/speaker AV tester came up in the forums a few weeks ago. Someone requested to see a project devoted to testing VGA displays and Speakers. The project I made many years ago: The VGA Test Box can be used to..... Listed under: [Development Board - Kits Projects](#)











2318.

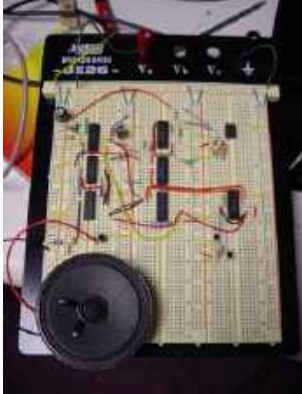

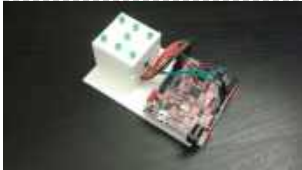
[DIY Datalocker](#) How to turn and ordinary external harddrive into a datalocker using only a PIC microcontroller, a keypad and some various other components. Step 1: Parts The parts you need: - 3.5" SATA harddrive enclosure - 2.5" SATA harddrive NOTE: This will not work with a..... Listed under: [Memory - Storage Projects](#)

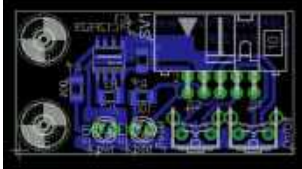
2319.  [USB digital GPIO I/O extender using pic microcontroller](#) description Add general purpose input/output lines to your computer based projects. This circuit is a 12 pin digital GPIO interface using the Microchip PIC18f14k50 microcontroller which connects to an USB host port. The microcontroller is available in through-hole DIP20 and SMD packages, too. Circuit diagram..... Listed under: [Interfacing\(USB - RS232 - I2c -ISP\) Projects](#)
- 
2320.  [Granular Flow Rotating Sphere using pic-microcontroller](#) Spring Quarter Update This zip file contains the documentation, MATLAB code/examples, PIC code and circuit diagram. <http://hades.mech.northwestern.edu/wiki/images/3/3d/Tumbler.zip> Contact Scott McLeod for further questions. Team Members Brian Kephart - Electrical Engineering Class of 2009 Jonathan Shih - Mechanical Engineering Class of 2009 Kristi Bond - Mechanical..... Listed under: [Home Automation Projects](#)
- 
2321.  [7 Segment LED display with PIC controller and Flowcode V5](#) First of all, if you have any questions, feel free to comment! I'd be more than happy to answer your question as good as possible!! Materials used : - PIC 18F452 Microcontroller ( any PIC microcontroller with enough pins will do ) - 7 Segment..... Listed under: [LED Projects](#)
- 
2322.  [make your own wearable LED display using pic-microcontroller](#) jump to a section:supplies about LED arrays design construction customizing/programming washing and wearing troubleshooting and FAQ **\*\*NOTE\*\*** As of Fall 2007, skip the ugly microcontroller programming (don't buy the STK500 or the AVR chip)... Get a LilyPad Arduino instead. It's much easier to sew and..... Listed under: [LED Projects](#)
- 
2323.  [Wireless Sensor Motor Control using PIC18LF4520](#) Last week we took a look at how you can wirelessly connect together two unrelated microcontrollers; an Arduino UNO and a PIC. The week before that we showed you how to build Motor Control via Distance Sensing. This week, let's combine the two project together..... Listed under: [Motor Projects](#), [Projects](#), [Sensor - Transducer - Detector Projects](#)
- 
2324.  [2-Channel IR Relay Controller for PIC10F200](#) Description This project is a 2 channel infrared (IR) remote controlled relay driver with power saving. It works with 12-bit SIRC IR signals as used by Sony remote controls. The controller also features a power save feature which reduces the relay holding voltage to 50%..... Listed under: [Internet - Ethernet - LAN Projects](#), [LED Projects](#), [Projects](#)
- 
2325.  [Gas Cooker & Water Purifier Using Free Energy](#) I originally wrote this for my final year project in 2005. I won't provide a parts list as certain technology has moved on such as the ease of Arduino for the electronics and solar cells are a lot better and readily available now. Also I..... Listed under: [Other Projects](#)
- 
2326.  [Pinguino Egypt – PIC Based Arduino](#) It 's been eleven years since I first started learning and building my first Microchip PIC Microcontroller circuit. I really like this Microcontroller family. Recently, I started reading and trying some Arduino. I really wished to build a similar circuit based on the Microchip PIC..... Listed under: [Development Board - Kits Projects](#)
- 
2327.  [Computer-Controlled Light-Up Water Fountain using pic-microcontroller](#) System Overview La Fontaine Du Campus Est (The Fountain of East Campus) is a computer-controlled, servo-actuated, LED and halogen-lit, sump-pump powered water fountain. It features five streams of water that can each be individually controlled (on/off) as well as pivoted (90 degrees of freedom). Each..... Listed under: [Interfacing\(USB - RS232 - I2c -ISP\) Projects](#)
- 
2328.  [PIC KICK TWEET !](#) This is an Instructable showing you how to integrate Twitter in your embedded application. Watch this Instructable in Action <http://www.instructables.com/id/PIC-KICK-TWEET-1/> Working: A desktop application is created with ease for grabbing the latest tweet from your twitter account. The application then forwards the tweet to the serial..... Listed under: [LCD Projects](#)
- 
2329.  [USB Reprogrammable iButton door lock](#) iButtons are small button like casings that communicate with only 2 wires. They are incredibly robust and all have a unique serial number which is hardware written into the device and never repeated. They are cheap (about 1 Pound / 1,50 Euro/ \$2) This serial..... Listed under: [Interfacing\(USB - RS232 - I2c -ISP\) Projects](#)
- 
2330.  [Mädchen Machen Technik using pic-microcontroller](#) The "Mädchen Machen Technik" workshop is designed to give high school students an introduction to microcontrollers. The students will build a flashing light pattern and/or a counter-timer. In the process of building this project, the students will learn about microcontrollers and digital electronics. Here is..... Listed under: [LED Projects](#)
-

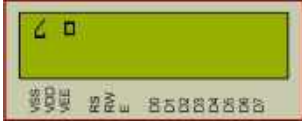

2331.  [Trippy RGB Color Mixing NightLight](#) Project is based on A Trippy Crystal Nightlight by Charles Platt in Make magazine volume 25, see URL below for additional details. A fun and simple project to get started with PICAXE microcontrollers. <http://www.makezine.com/25/electronics> In this version an inexpensive (> \$2.50) AC USB charger..... Listed under: [LED Projects](#)
- 
2332.  [Electronic Heart \(Flashing LEDs\) – Mother's Day Project](#) Mother's Day was approaching, and I am getting my 8 year old son started with electronics. So why not combine the two? In the next few pages we'll show you the project we did - a blinking heart with several effects, all driven by a..... Listed under: [LED Projects](#)
- 
2333.  [Circuit design and electronics using pic-microcontroller](#) I completed a 2-part assignment for this week. The first part was to build a sorta-random sound generator based on a schematic that Joe Paradiso made available. The second part was to build a circuit that could transmit MIDI messages - this will go towards..... Listed under: [Sound - Audio Projects](#)
- 
2334.  [The perfect Remote, Programmable, Controller for interactive LED strips](#) Since when white light emitting high brightness LED are available, the handover from traditional lighting bulbs to the solid-state lighting has become irreversible: LEDs have an efficiency (expressed in lumens/watt) higher than that of almost all the traditional lamps (except, at the moment, the large..... Listed under: [LED Projects](#)
- 
2335.  [3D Printed Microcontroller Dice Roller](#) This is a just-for-fun project I did in the Digilent MakerSpace. Usually whenever I play board games I use a dice-rolling smartphone app since dice are so easy to lose. I thought I would try making my own hardware version though. It turned out really..... Listed under: [chipKIT Projects](#), [LED Projects](#)
- 
2336.  [Microcontroller's based Password Locker](#) Hello Everybody , the goal of this instructables is to learn how to do a simple locker for your room, or anything which need to be safe. I've made it on a non-soldering card but there is the PCB if you want to make it..... Listed under: [Calculator Projects](#)
- 
2337.  [Picaxe Projects #1: Making Fast Printed Circuit Modules](#) Experimental circuit board modules can be made quickly and fairly easily. They have the advantage of being more than twice as fast to build than a custom circuit board. They are also easy to test in a breadboard. The modules detailed here are ones I..... Listed under: [Development Board - Kits Projects](#)
- 
2338.  [Intel D945GCLF Small Front Panel using PIC12F629](#) Description This is a simple circuit with two buttons and two LEDs to control the D945GCLF Intel motherboard. Both power and reset buttons are included as well as hard disc activity LED and power status LED. The special feature included is the sleep effect of Apple..... Listed under: [Projects](#), [RTOS - OS Projects](#)
- 
2339.  [PIC18 Development Board with Ethernet and USB](#) In this instructable I'm going to show you how to make your own PIC18 development board that features both Ethernet and Full Speed USB 2.0 at a low cost. Features: The development board is based on a PIC18LF4553 microcontroller. The microcontroller features a Full Speed..... Listed under: [Development Board - Kits Projects](#)
- 
2340.  [How to display custom characters on LCD using PIC16F877](#) This post explains the idea of creating custom characters on any LCD ( e-g on 16x2 LCD ) which has HD44780U controller in it. Almost all 16x2 or 20x2 LCDs have HD44780U controller in them[1]. This controller provides the functionality of CGRAM ( Character Generator..... Listed under: [LCD Projects](#), [Projects](#)
- 
2341.  [Top Microcontroller based Mini Projects for 3rd and 4th Year Engineering Students](#) Microcontroller is a small and self-contained computer on-chip which can be used to build several low-cost and less-complex projects. As the microcontroller based mini projects are of low cost and can be implemented in less span of time, most of the students prefer this controller..... Listed under: [Microcontroller Programmer Projects](#)
- 
2342. [IR-Sensor Circuit and Interfacing with PIC Microcontroller](#) An IR sensor is an electronic device, that produces in order to detect some parts of the environs. An infrared sensor can measure the heat of an object as well as detects the motion. These sensors are used to measure only IR radiation, rather than..... Listed under: [Sensor - Transducer - Detector Projects](#)

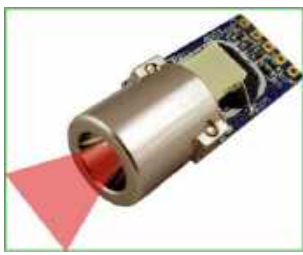

2343.



[Wireless Home Appliance Controller Project](#) In this post we discuss about Microcontroller based Wireless Home Appliance Controller Project.You can Control Any Home Appliance Like Tv ,Radio Fan,Bulbs Using This Project. Mainly we use Mikro C Programming Language in this Project and ISIS Proteus Software use for testing Purposes. Mikro C..... Listed under: [Home Automation Projects](#), [Wireless Projects](#)

### Search

### LET'S SOCIALIZE



### [Explore All Categories](#)

#### USEFUL RESOURCES

- Tools
- [Advance Search](#)
- [Online Courses to Learn Programming.](#)
- [Pic Projects PDF Offline](#)
- [Pic16f877a projects list](#)
- [Pic18f4550 projects](#)
- [Proteus Simulation Based Pic Projects](#)
- [Online Courses to Learn Pic Microcontroller Programming.](#)
- [Programming jobs on Jooble](#)

#### Advance Search

[Advance Search](#)

#### Subscribe to Category

**Subscribe To A Specific Category**

Get Notified Whenever There Is A New Project In Your Desired Category

[Subscribe!](#)